

## Consulting, development, production and maintenance – all under one roof

### Commitment – We're here for you!

As an owner-managed, medium-sized family company with over 1400 employees worldwide, ARGO-HYTOS has been serving its customers for more than 70 years. With production companies in Germany, the Czech Republic, Poland, China and India as well as numerous own distribution and assembly companies, we are able to offer our customers local support, providing them with reliable contacts.

We are the right partner for your project! Our development and manufacturing expertise allows us to accompany a product throughout the process of its creation. From the conceptual phase to the individualized system solution, we work closely with our customers every step of the way.

For decades, ARGO-HYTOS has developed a relationship with its customers based on trust and continually strives to surpass their needs and expectations, validating the trust placed in us through quality and reliability.

### Innovation, competence, quality

We possess extensive development know-how based on the latest manufacturing technologies. We provide all products and process chains under one roof and support our customers in component integration, the development of new and innovative solutions as well as in the optimization of existing systems.

### Global presence – Customer satisfaction always and everywhere

ARGO-HYTOS is globally represented with numerous own sales companies. In addition, we collaborate with a network of skilled sales and service partners in all important core markets, ensuring proximity to the customer and a local presence. Our global network of specialists means that you always have a reliable partner at your side. This allows us to provide our customers with the best possible support – from the concept phase up to after-sales service!

### International

## ARGO-HYTOS worldwide

<b>Benelux</b>	ARGO-HYTOS B. V.	info.benelux@argo-hytos.com
<b>Brazil</b>	ARGO-HYTOS AT Fluid Systems Ltda.	info.br@argo-hytos.com
<b>China</b>	ARGO-HYTOS Fluid Power Systems (Yangzhou) Co., Ltd. ARGO-HYTOS Fluid Power Systems (Beijing) Co., Ltd. ARGO-HYTOS Hong Kong Ltd.	info.cn@argo-hytos.com info.cn@argo-hytos.com info.hk@argo-hytos.com
<b>Czech Republic</b>	ARGO-HYTOS s.r.o. ARGO-HYTOS Protech s.r.o.	info.cz@argo-hytos.com info.protech@argo-hytos.com
<b>France</b>	ARGO-HYTOS SARL	info.fr@argo-hytos.com
<b>Germany</b>	ARGO-HYTOS GMBH	info.de@argo-hytos.com
<b>Great Britain</b>	ARGO-HYTOS Ltd.	info.uk@argo-hytos.com
<b>India</b>	ARGO-HYTOS PVT. LTD.	info.in@argo-hytos.com
<b>Italy</b>	ARGO-HYTOS srl	info.it@argo-hytos.com
<b>Poland</b>	ARGO-HYTOS Polska sp. z o.o.	info.pl@argo-hytos.com
<b>Russia</b>	ARGO-HYTOS LLC	info.ru@argo-hytos.com
<b>Scandinavia</b>	ARGO-HYTOS Nordic AB	info.se@argo-hytos.com
<b>Turkey</b>	ARGO-HYTOS	info.tr@argo-hytos.com
<b>USA</b>	ARGO-HYTOS Inc.	info.us@argo-hytos.com

Visit our website [www.argo-hytos.com](http://www.argo-hytos.com) for more information on our global sales and distribution partners.

**Your competent partner in fluid power**

## Custom Solutions by ARGO-HYTOS

### The Challenge

The demands posed on sawing machines – whether fully automated, semi-automated or manual – regarding speed, cutting precision and required cut surface quality keep increasing. The main focus is on the resulting controllability and modularity, as well as energy efficiency of the hydraulic systems. This combination of requirements calls for a deep understanding of the application, both in project planning and in developing system-specific components.

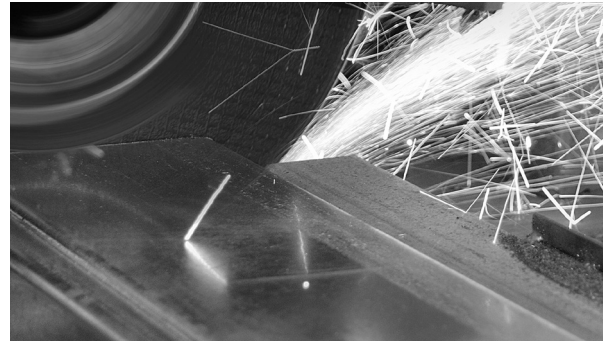

### Our Expertise

ARGO-HYTOS has been working with the leading sawing machine manufacturers for decades. We closely collaborate with our customers to develop components, clever subsystems and innovative system solutions, combining sensor, filtration and valve technology. Some examples are:

- › Band tensioning
- › Clamping and locking
- › Saw feed
- › Complete power unit

In addition to pressure, temperature and flow sensors, oil condition monitoring has become more important in recent years, often in the form of portable units for servicing. One of the main reasons for this is the goal to further increase machine uptime.

The collection, transfer and analysis of data present a significant benefit for manufacturers and operators in terms of predictive maintenance.



### Your Custom Solution

ARGO-HYTOS offers a wide range of highly compatible filtration, valve and sensor products for your application. We adapt and modify components or individual function elements in such a way that the function in your machine is realized according to your wishes. We combine valve, filter and sensor technology to create subsystems and compact function units, which help you reduce assembly and piping costs. We are able to react quickly and flexibly to specific customer and market demands thanks to our considerable manufacturing expertise and level of in-house production.

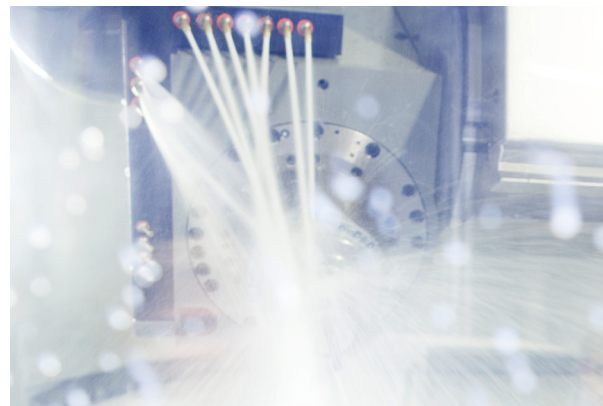

### Applications

# SAWING MACHINES

Our expertise for your success

# WORKING HYDRAULICS

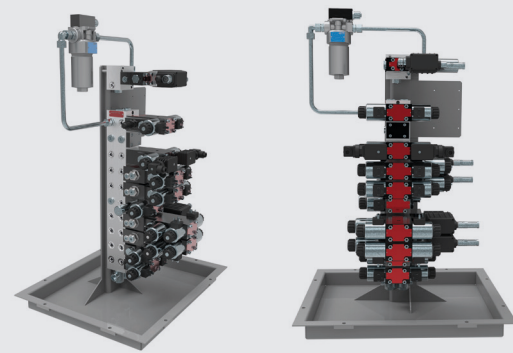

1 Custom manifolds

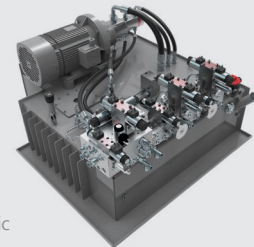

2 Custom hydraulic power units



3 Clamping pressure reduction

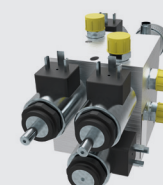

4 Band tensioning

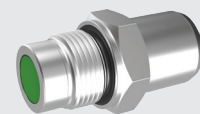

6 Wear sensors

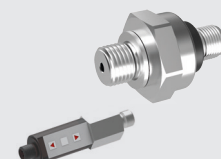

7 Pressure sensors

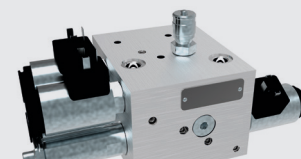

11 Vice retraction, hydr. bundle cutting attachment (top clamp)

## ARGO-HYTOS: Your project – our passion – succeeding together

- › You want to redesign, modernize or adapt your machine to a regional market – we have the system knowledge, the components and the project planning competence to help you realize it.
- › You determine and define functionality – we provide possible solutions
- › We combine local and central value-added shares in order to meet the highest requirements with regard to function safety, reliability and cost effectiveness.
- › Our Applications Team, together with a given local entity and the development manager of the customer, supports projects from initial inquiry up to the start of series production. We maintain and observe highest internal standards in the processing of international projects in global core markets thanks to competent local contact persons and applications experts in our applications center.

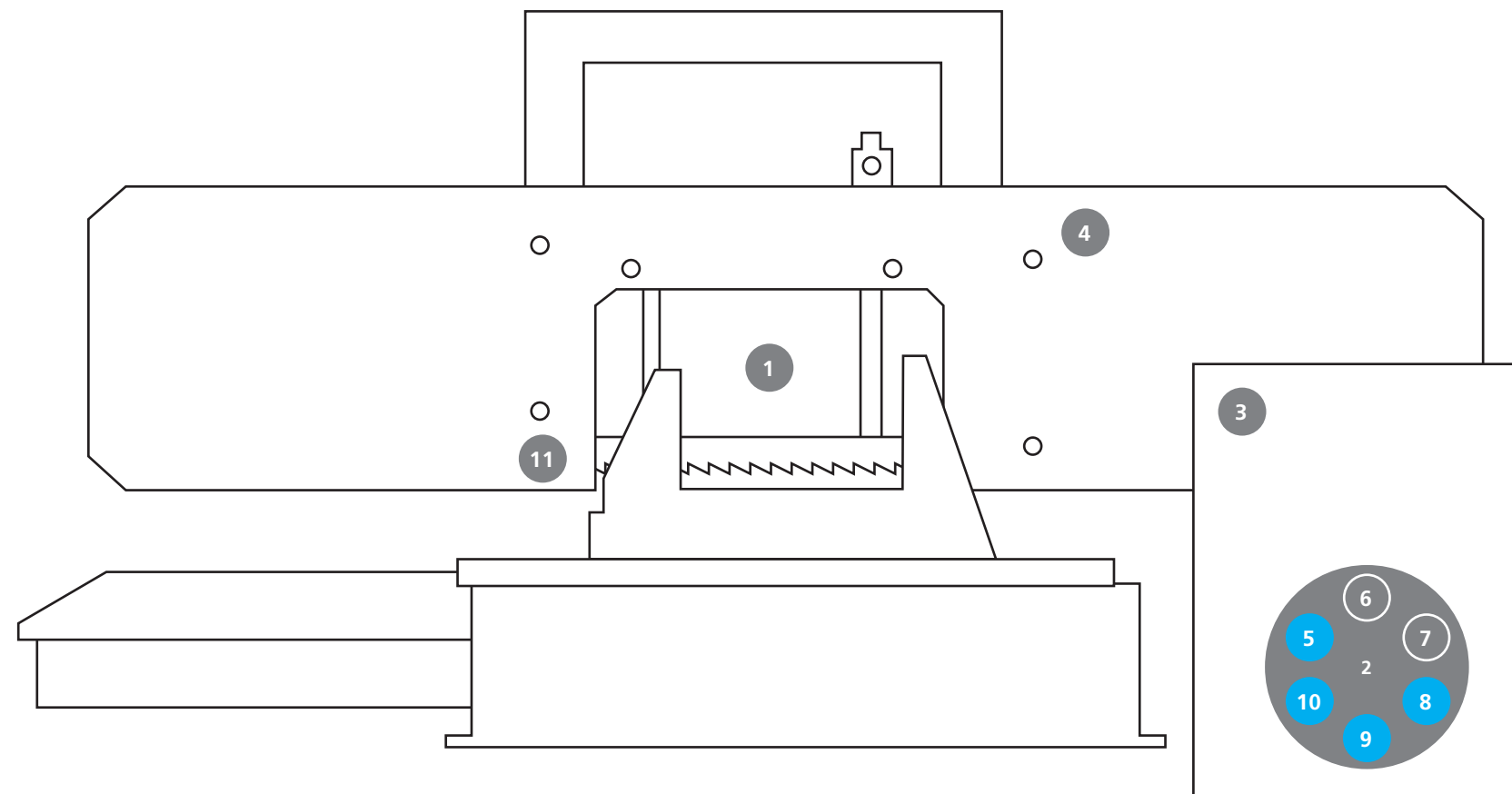

■ Working hydraulics  
■ Filtration

## CONDITION MONITORING



OPCom Oil particle monitor

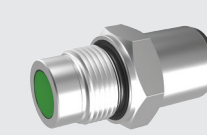

OPCom FerroS Wear sensor



LubCos H<sub>2</sub>O+ II Oil condition sensor

## OIL SERVICE UNITS for service or retro-fitting



FA Oil service unit

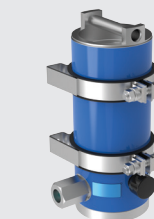

FNS Off-line filter



FNA Off-line filter unit

## HIGH END FILTER ELEMENTS



Replacement element in EXAPOR®MAX 2 quality



Filter element for EXAPOR®MAX 2 or EXAPOR®MAX Fit

# FILTRATION

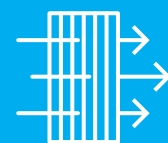

5 Suction filter



8 Filling filters & breathers



9 Return and breather filters



10 High-pressure filters

### Filter INFO

#### Replacement element in EXAPOR®MAX 2 quality

- › best service life in class
- › excellent component protection
- › proven reliability
- › optimizes your life-cycle costs
- › our alternative for you is the **EXAPOR®MAX Fit**

The EXAPOR®MAX 2 filter element generation is designed for highest performance. The unique 3 layer fine filter media offers a very low pressure drop in combination with a high dirt holding capacity. These fine filter layers are supported and protected by a patented hybrid mesh screen which guarantees a unique flow fatigue stability. The polyester shrink sleeve protects the filter element from damages and is printed with the ARGO-HYTOS EXAPOR®MAX 2 label for identification as a genuine spare part. Improved copy protection is achieved by customized labels. The same quality features are incorporated in the EXAPOR®MAX Fit series to upgrade housings of other manufacturers with the ARGO-HYTOS technology.