



THE **MOST ADVANCED** RANGE OF **ELECTRIC WHEELS**



PRODUCTS
GUIDE 2016

Company

ez-Wheel SAS is an innovative technology company founded in 2009.

Registered in France with a capital of 450,910€, our company develops a range of autonomous electric wheels, dedicated to the industry. Our solutions assist operators in moving heavy loads.

Located in Charente, in the heart of the Mechatronic Valley, ez-Wheel benefits from geographical and economical opportunities, with a strong network of local industrial players.

ez-Wheel innovative technology and industrial know-how result from the combination of well-known technologies and proven methodologies.



ez-Wheel's Head Office, St-Michel - FRANCE.

Research and Development

A R&D-driven strategy

The company dedicates most of its resources to Research and Development in innovating methods. ez-Wheel team's industrial experience ensures good assessment and management of risks related to the delivery of innovative products to market: technological choices favour mature and secure solutions, embedded features of the products correspond to those usually required by professionals in the field, the production process uses controlled and standardized methods

Quality Commitment

An ISO 9001 management system

The quality policy reflects the company's values and senior management's commitment which share a common objective:

FULL AND LASTING CUSTOMER SATISFACTION.

OUR 3 STRATEGIC STRANDS:

1. Product and services quality beyond legal and regulation requirements, meeting scheduled lead times and satisfying customer expectations.
2. The competitiveness of our offer and its permanent evolution are part of an innovative and well-reasoned approach supported by best practices and the manufacturing experience of our partners.
3. A respectful and constructive social policy allowing employees to fully develop their skills and well-being is key to the success of our business as is their commitment to our Quality Policy.



Intertek

FRANCE
0027313-00

ISO 9001
v.2008

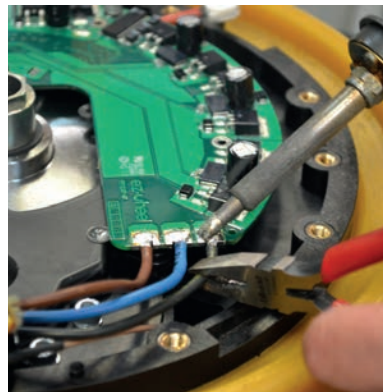

The first electric wheel integrating motor and batteries

The technology proposed by ez-Wheel is the fastest, simplest and most advanced solution offering electric traction to mobile materials in all industries, including but not limited to : medical environment, food industry, and heavy load handling.

The solution fully integrates into a wheel all the functions of a conventional power train: high-end electric motor, high energy and super long life batteries, power controller featuring state of the art motor control, battery management and wireless interface.

ez-Wheel products are ready to operate in outdoor or indoor conditions, over an extended temperature range. All the components including the battery are designed to withstand up to 5 years of operation without any maintenance required.

ez-Wheel wireless technology removes all the peripherals, wire sets and connectors from the chassis, making the integration of our solutions a fast and easy task compared to other alternatives.



ez-Wheel's products range.

Electronics

The brain of the wheel is powered by two micro-controllers and two real-time operating systems. It enables wireless communication, battery management and full customization of the wheel's features.

Motor

The high torque and ultra-compact drive is ensured by a high-tech permanent magnet motor, and a mechanical reducer fully integrated into the wheel's architecture.

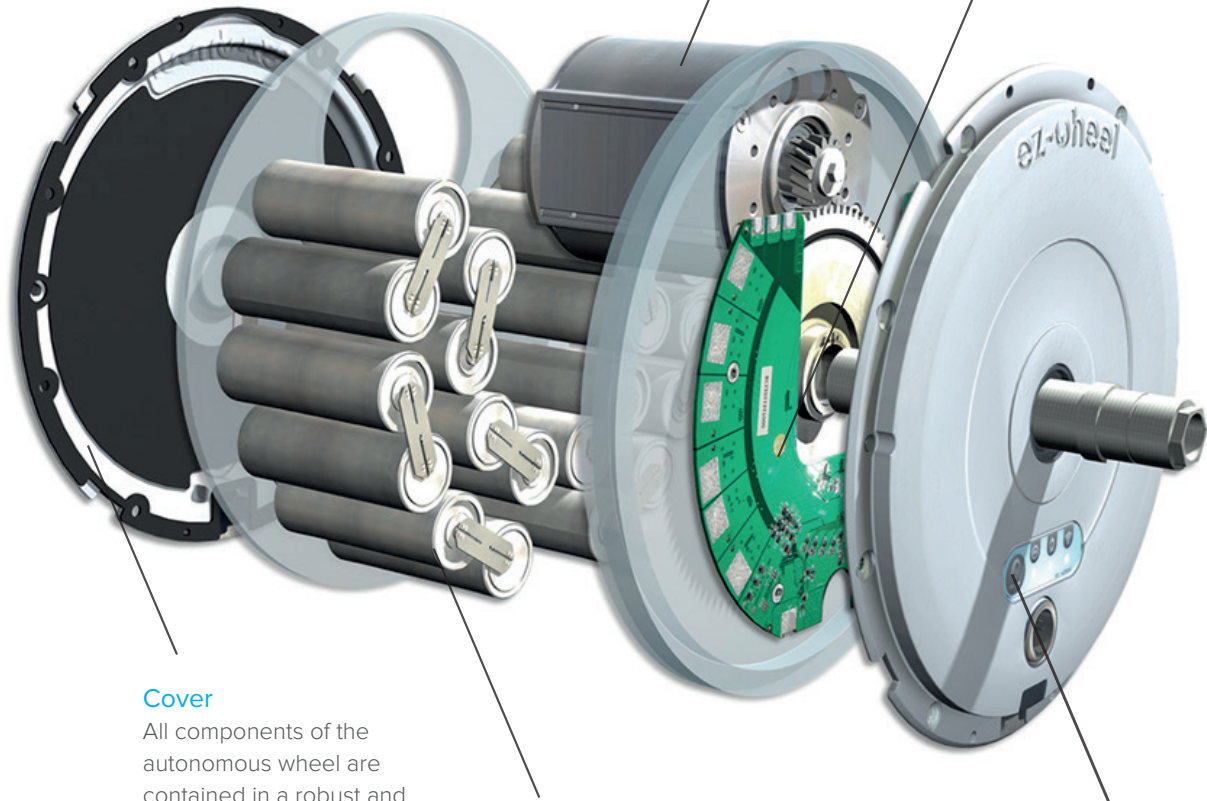

Cover

All components of the autonomous wheel are contained in a robust and totally waterproof cover. The wheel is able to operate in the toughest environments.

Battery

The energy embedded in the wheel is stored in a cutting-edge Ni-Mh battery. Built to last rock-solid and reliable, this technology is also one of the safest available on the market.

HMI

The user interface is extremely simple. It includes the wheel recharge connector, a diagnostic button, and lights indicating the wheel battery level and wireless communication status.

Market Segments

AUTOMOTIVE INDUSTRY



ez-Wheel self-recharging during towing feature is the perfect fit for towed material running 3 shifts per day.

MAINTENANCE FREE

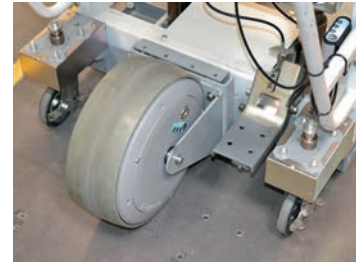

LOAD HANDLING



ez-Wheel self-propelled electric wheels are ideal for handling equipment and moving heavy loads.

SAFETY + PRODUCTIVITY



LOGISTICS



ez-Wheel solutions are ideal for picking trolleys and platform trucks designed for hundreds of starts and stops per working shift.

EFFICIENCY + FLEXIBILITY





FOOD PROCESSING INDUSTRY

ez-Wheel sealed and waterproof products can operate in severe environments over a wide temperature range.

COMPATIBILITY + RELIABILITY



MEDICAL

ez-Wheel self-propelled electric wheels are ideal to preserve the health capital of healthcare workers.

SAFETY + RELIABILITY



OUTDOOR

ez-Wheel products can be used outside on bitumen or turf, as well as chaotic terrain. ez-Wheel outdoor range offers a solution for each mobility need.

ZERO EMISSION



Series 300

The Universal Series

The Series 300 electric wheels can be immediately installed on the chassis of any vehicles or wheeled equipment. No electrical connection is required as the wheel is self-powered by the built-in battery and can be remotely controlled.

Series 300 Main specifications

Speed	0 to 12 km/h
Nominal power	200 W (S1 at 6 km/h)
Battery capacity	240 Wh
Torque peak	52 Nm
Pushing force	35 daN / moves 1t
Max vertical load	Supports up to 300 kg



- WIRELESS
- IP65 WATER RESIST.

Ref. **ezW300M/W**

Main specifications

Format/Diameter	304 mm
Type of tyre	70 sh. A polyurethane
Suitable for	Hospital equipment Stretchers & Indoor mobile equipment



- WIRELESS
- IP65 WATER RESIST.
- GRIP
- CLEANING

Ref. **ezW300F/W**

Main specifications

Format/Diameter	304 mm
Type of tyre	Enhanced grip 50 sh. A polyurethane
Suitable for	Pusher/Puller in food processing industry Industrial trolleys



- WIRELESS
- IP54 RUGGEDIZED

Ref. **ezW300I/W**

Main specifications

Format/Diameter	300 mm
Type of tyre	80 sh. A polyurethane
Suitable for	Industrial hand trucks Logistics equipment



- WIRELESS
- IP54 RUGGEDIZED
- REGEN.

Ref. **ezW300I/WR**

Main specifications

Format/Diameter	300 mm
Type of tyre	80 sh. A polyurethane
Feature	Regen
Suitable for	Towed Trailers Lean Trolleys



- WIRED
- IP54 RUGGEDIZED
- SERIAL
- WIRELESS

Ref. **ezW300I/CC**

Main specifications

Format/Diameter	300 mm
Type of tyre	80 sh. A polyurethane
Features	Serial link
Suitable for	Industrial hand trucks Logistics equipment



- WIRED
- IP54 RUGGEDIZED
- SERIAL
- REGEN.
- WIRELESS

Ref. **ezW300I/CCR**

Main specifications

Format/Diameter	300 mm
Type of tyre	80 sh. A polyurethane
Features	Serial link Regen
Suitable for	Towed Trailers Lean Trolleys

Wheel's characteristics



MAINTENANCE-FREE

All components are designed for a maintenance-free lifespan of up to 5 years. The very long-life batteries used in the wheel can sustain thousands of use and recharging cycles.

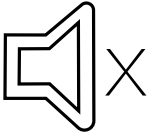

QUIET

The motor technology and mechanical transmission are designed to run extremely quietly and vehicles fitted with them will not generate more noise pollution.

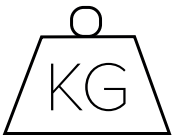

UP TO 1 TON

With peak torque of 52 Nm, the electric motor develops a pushing force of 35 daN. It provides exceptional clearance capability and equipment fitted with the motor can carry loads of several hundred kg.

Reference's building

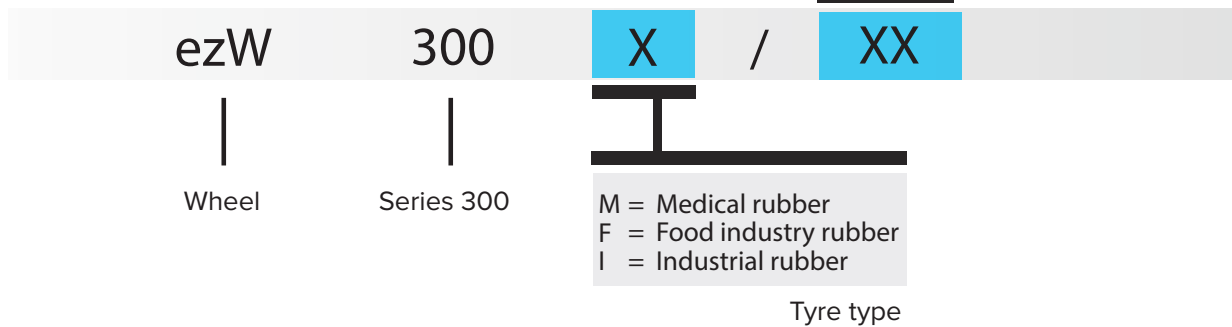

REGEN Feature

Regenerative charging is an exclusive function developed by ez-Wheel. It enables the built-in battery to be recharged with the wheel rotation kinetic energy.

The wheel can be charged while rotating at a speed between 3 and 12 km/h, for instance during the towing phase of a trolley.

In this phase, the wheel switches into the charging mode automatically as soon as rotation is detected. The wheel then presents a resisting (braking) torque and the braking energy recovered by the motor is injected back into the battery.

Available Wheels

Wheels / References	Designation - Series	Type
ezW300M/W	Series 300 wheel	Medical rubber - Wireless communication
ezW300F/W	Series 300 wheel	Food industry rubber - Wireless communication
ezW300I/W	Series 300 wheel	Industrial rubber - Wireless communication
ezW300I/WR	Series 300 wheel	Industrial rubber - Wireless communication - Regen
ezW300I/CC	Series 300 wheel	Industrial rubber - Charge Cable (wired) - Wireless or Serial
ezW300I/CCR	Series 300 wheel	Industrial rubber - Charge Cable (wired) - Regen - Wireless or Serial

Series 10"

The **all terrain** solution

The Series 10" wheels can be used outside on bitumen, and turf, as well as chaotic terrain. The range offers a solution for each outdoor mobility problem you will encounter.

Series 160 Main specifications

Speed	0 to 18 km/h
Nominal power	250 W
Battery Capacity	240 Wh
Torque peak	52 Nm
Max vertical load	Supports up to 150 kg per wheel



Ref. ezW10N/W

The nude hub can be fitted with any 4.00*10" inflated tyre.



Ref. ezW10R/W

The ezW10R is suitable for delivery carts, personal carriers, urban pedestrian vehicles. The wheel is equipped with a road tyre 100-80-10.

Ref. ezW10G/W

The ezW10G is suitable for wheelbarrows, devils, easel trolley, storage carts. The wheel is equipped with a thread pattern tyre 120-90-10.

Ref. ezW10T/W

The ezW10T is suitable for street clearing carts, urban vehicles. The wheel is equipped with a trailer type tyre 4.00*10".

Ref. ezW10A/W

The ezW10A is suitable for weedier, off-road machine, mobile equipment on chaotic surface. The wheel is equipped with an agriculture tyre 4.00*10".

A Tyre solution

For each kind of ground

Wheel's characteristics



IMMEDIATE FITTING

The self-propelled ez-Wheel can be fitted immediately on any vehicle chassis or mobile equipment. No electrical connection is needed, since the wheel is self-powered by the built-in battery and driven by wireless communication.



ALL TERRAIN SOLUTION

The high torque of the embedded motor allows running on any type of ground. With the water resistant and rugged envelope, it makes a perfect fit for severe outdoor environments.



MAINTENANCE-FREE

All components are designed for a maintenance-free lifespan of up to 5 years. The very long-life batteries used in the wheel can sustain thousands of use and recharging cycles.

Reference's building

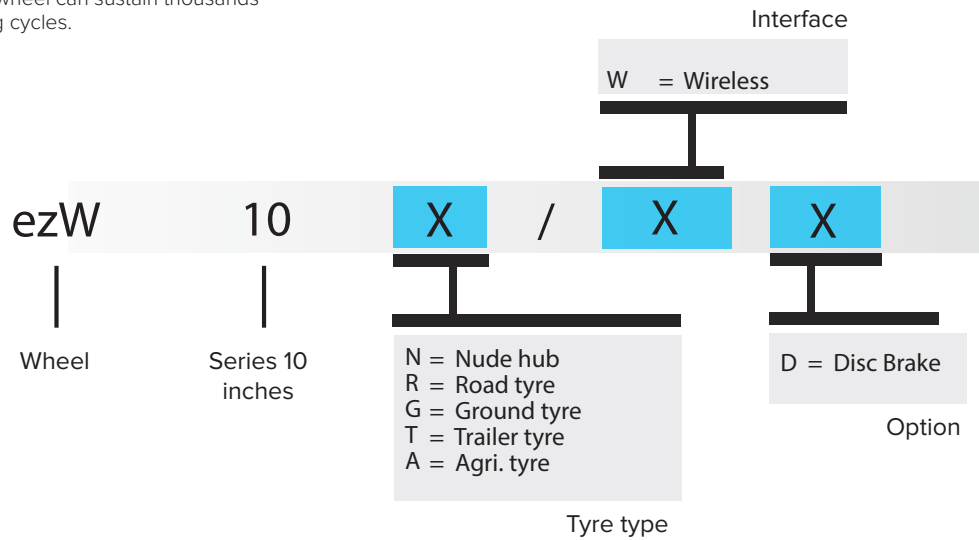

Available Wheels

Wheels / References	Designation - Series	Type
ezW10N/W	Series 10" wheel	Nude hub
ezW10R/W	Series 10" wheel	Road tyre
ezW10G/W	Series 10" wheel	Ground tyre
ezW10T/W	Series 10" wheel	Trailer tyre
ezW10A/W	Series 10" wheel	Agriculture tyre
Available Versions/Options		
D	Wireless + Disc brake holder	

Disc BRAKE Options



This option is a disc holder mounted on the wheel. It is suitable for a standard 6 holes disc brake.

The disc brake option allows dynamic braking and secures your rolling material.

Series 160

The modular Series

The Series 160 wheels incorporate motor and batteries in an extremely small footprint. The reduced height allows the wheels to be installed under very low chassis.

Series 160 Main specifications

Speed	0 to 5 km/h
Nominal power	70 W (S1 at 4 km/h)
Battery Capacity	• 70 Wh (1 battery) • 140 Wh (2 batteries)
Torque peak	16 Nm
Pushing force	20 daN / moves 500 kg
Max vertical load	Supports up to 50 kg (use suspension p35)



DISCONTINUED
Consult ez-Wheel for specific need

Ref. **ezW160I**

Main specifications

Format/Diameter	158 mm
Type of tyre	70 sh. A polyurethane
Features	0/1/2 batteries
Suitable for	Industrial hand trucks Roll carts Picking trolleys



Ref. **ezW160M**

Main specifications

Format/Diameter	158 mm
Type of tyre	70 sh. A polyurethane
Features	0/1/2 batteries
Suitable for	Medical beds Service trolleys Operating tables

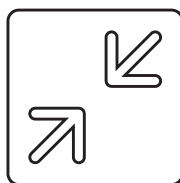

REDUCED SPACE REQUIREMENT

The Series 160 integrates motor and batteries in an extremely compact format. The wheel is designed with reduced height to fit any low chassis. The robust housing protects all components from knocks and splashing.

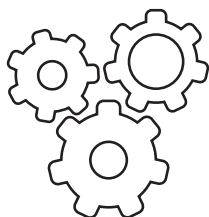

HIGH COMPATIBILITY

The self-propelled ez-Wheel can be fitted immediately on any vehicle chassis or mobile equipment. The wheel is self-powered by the built-in battery and controlled by wired communication.



ENCODER Feature

The encoder function allows using advanced speed control features such as:

- Speed limiting
- Free wheeling
- Soft deceleration



Reference's
building

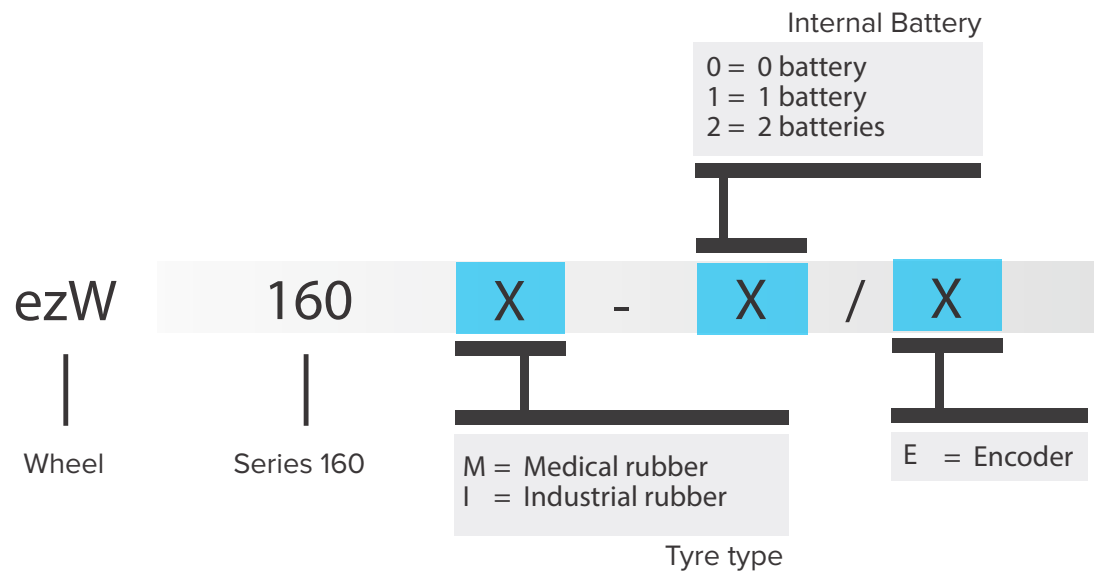

Available Wheels

Wheels / References	Designation - Series	Type
ezW160M-0/E	Series 160 wheel	Medical rubber wheel for external battery
ezW160M-1/E	Series 160 wheel	Medical rubber wheel with one internal battery
ezW160M-2/E	Series 160 wheel	Medical rubber wheel with two internal batteries
ezW160I	Series 160 wheel	Discontinued: consult ez-Wheel for specific need

Series 200

The **powerful** Series

Series 200 wheels are a concentration of power in an extremely small footprint for the handling of heavy loads in industry and automated machinery.

This electric wheel is dedicated to tough usage. Its performances manage easily heavy loads, repeated movements or continuous operation.

Series 200 wheels are adapted to:

- Heavy load transportation
- AGVs
- Industrial vehicles

Main specifications

Format/Diameter	200 mm
Type of tyre	92 sh.A polyurethane
Pushing force	100 daN / moves 3t
Max vertical load	Supports up to 1000 kg
Motor power	Motor deceleration
Options	Brake
	Wireless
	CAN bus
	Ext/Int battery



PRODUCT UNDER
DEVELOPMENT



ez-Config

Configure your Wheel...

ez-Config is the heart of the ez-Wheel solutions. Thanks to their software configurations, wheels and hand controls are programmable and can be perfectly adapted to any situation.

- ### Features
- Simple programming
 - Intuitive interface
 - Accurate data
 - Compatibility: Windows XP and above
 - English Interface

... in 3 steps

01 ENVIRONMENT
Evaluate and understand the working place characteristics

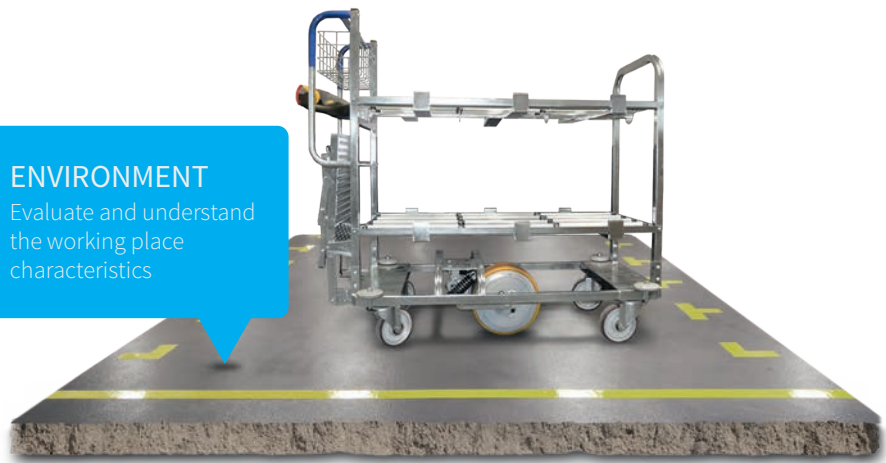

02 CONNECTION
Open ez-Config and connect ez-Wheel devices with USB port

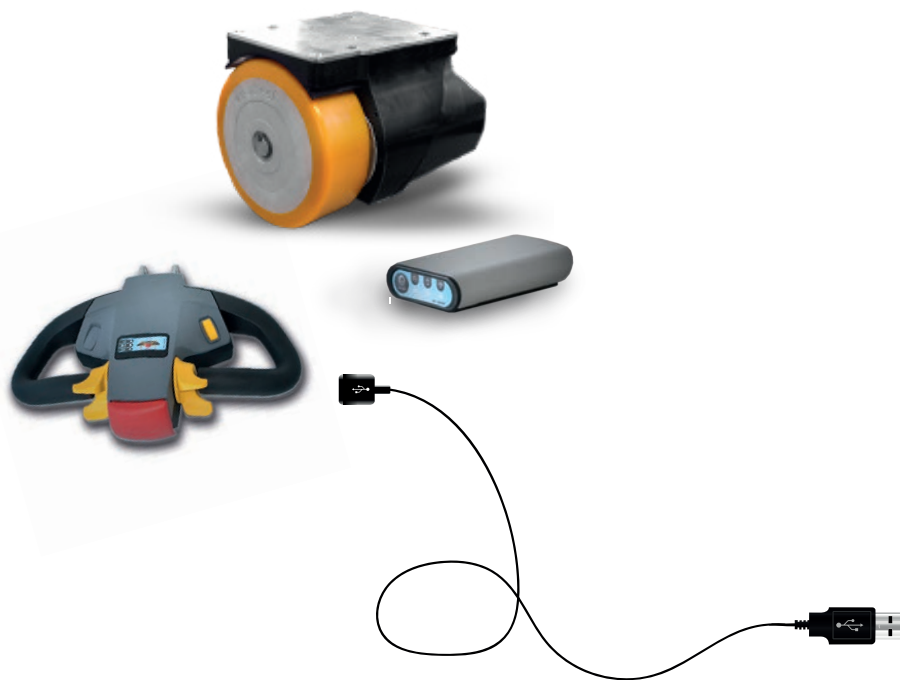

03 CONFIGURATION
Configure wheels and accessories
Save parameters

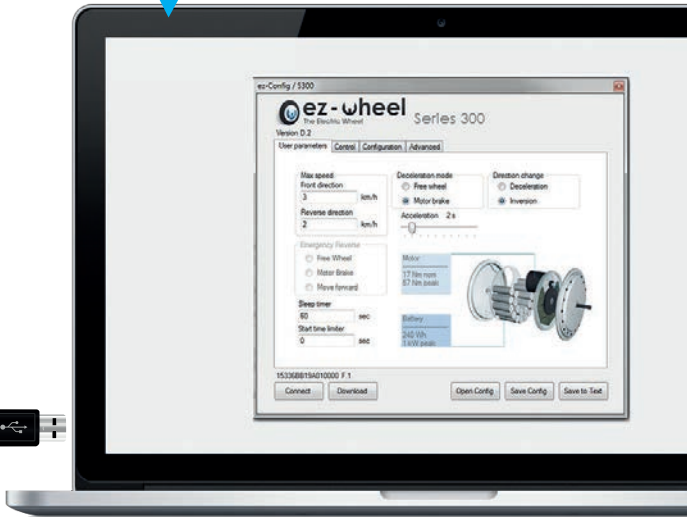

Available versions

References	Designation	Suitable for:
ezConfig/300	Configuration software	Series 300-10" and Smart Controls
ezConfig/160	Configuration software	Series 160

Configuration Parameters

The «user parameters» tab window allows to set the configuration parameters. Different settings are possible:

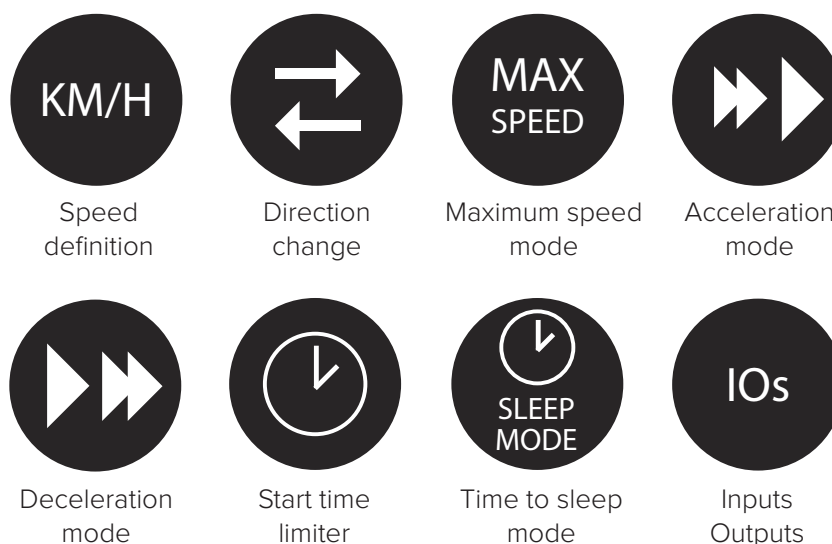

Settings	Designation
Speed Definition	Define the speed of the wheel. Forward and Backward speed can be differentiated.
Direction Change	It enables the user to adjust the behaviour of the wheel during a change in the set direction; 2 modes are available : «Deceleration» and «Inversion».
Maximum Speed Mode	The field box "Max speed mode" can be used to set up the behaviour of the wheel when the rolling speed exceeds the maximum speed value entered in ez-Config.
Acceleration Mode	Set up the acceleration according to your needs. e.g. Slow for patient moving, fast for picking trolley.
Deceleration Mode	Choose the deceleration behaviour when releasing the hand control. e.g. motor brake resistance, free wheel to continue rolling.
Start Time Limiter	Limit the motor drive time on start up. When the hand control is released the wheel goes back to the selected deceleration mode.
Time to Sleep Mode	In the «Sleep Timer» field it is possible to enter a value in seconds corresponding to the waiting time between the absence of activity on the actuator and switching of the interface to the sleep mode.
Inputs Outputs	Configure external interfaces for the displays, buttons, external supply...



CONTROLS AND ACCESSORIES

Smart Controls

WIRELESS TILLER HEAD CONTROL

Ref. ezRTH/W
 Ref. ezRTH/W/IP (product with IP65)
 WIRELESS - Bi-directional

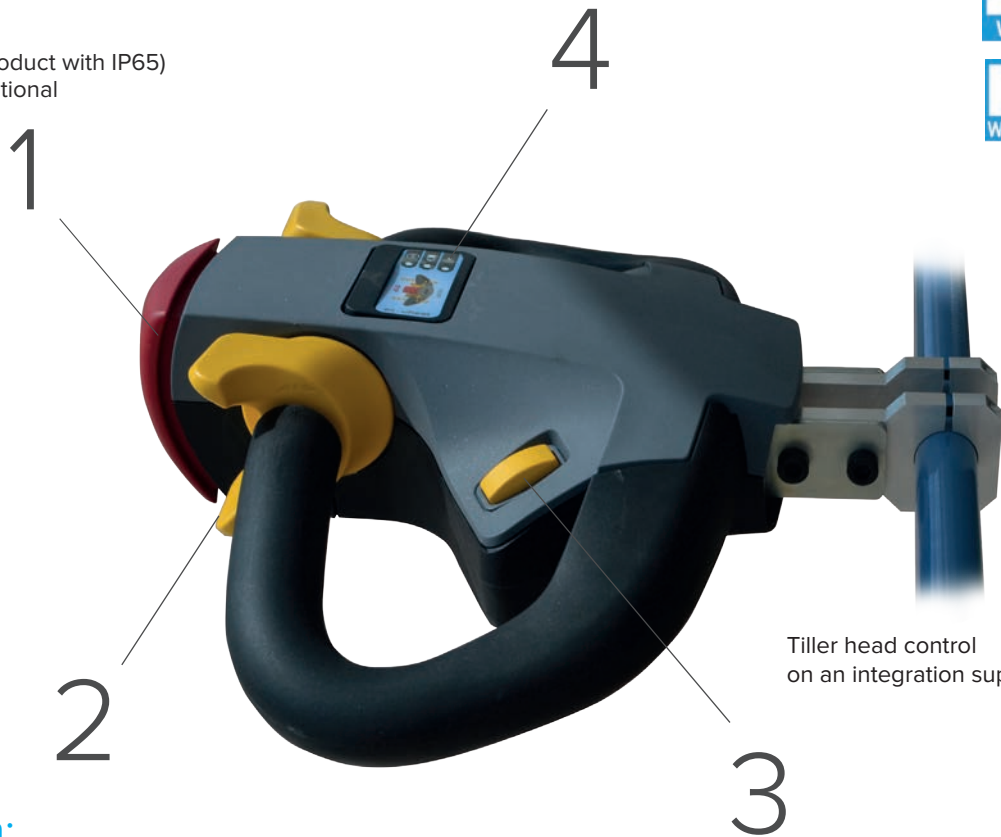

Tiller head control on an integration support.

Description:

It ensures a proper handling of equipment thanks to ergonomic shapes and well organised commands. The integrated wireless interface allows a simple and quick integration on rolling material.

Other functions:

The interface remotely displays the battery level of the wheel and the system status. It is powered by its own internal battery.

Features	ezRTH/W	ezRTH/W/IP
Belly Button (1)	■	■
Progressive accelerator (2)	■	■
ON/OFF button (3)	■	■
HMI Label (4)	■	■
Protection Index	IP54	IP65
Klaxon (5)		■
XLR Waterproof Cap (6)		■
Waterproof battery		■

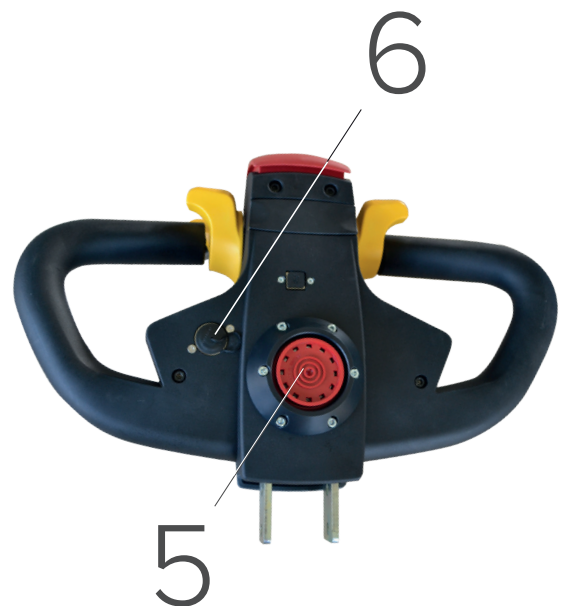

Suitable for:

- Series 300
- Series 10"

PUSH PULL SENSITIVE CONTROL

IP54
RUGGEDIZED

Ref. ezRPP/W
WIRELESS - Bi-directional - Sensitive sensor



Description:

It ensures a natural handling of equipment thanks to sensitive sensors, ergonomic shapes and well organized commands. The integrated wireless interface allows a simple and quick integration on rolling material.

Other functions:

The interface remotely displays the battery level of the wheel and the system status. Its internal battery ensures up to 6 months of autonomy.

Features

Dead-man switches for activation (1)

Pressure sensors in Push and Pull directions (2)

Battery and status indicator (3)

ON/OFF button (4)

IP 54

Suitable for:

- Series 300



Push Pull sensitive control on an integration support.

* for specific use: contact your dealer to check availability

The ez-Wheel[®] interface

The interface remotely displays the battery level of the wheel and the system status.

The ez-Box can be mounted on a chassis with fixing collars, or on a drilled panel with bolts.

Wireless ez-Box	
Communication Protocol	Wireless 2.4GHz IEEE 802.15.4
Battery	Ni-MH rechargeable
Dimensions	124 x 75 x 27 mm



WHEELS
SERIES 300 & 10"
 Page 08 - 11



Ref. ezR44IN/W

Suitable for:

- Series 300
- Series 10"

COMMUNICATION

ez-Box / Wheel

The wireless interface ez-Box is used to remotely control one or two wheels

01

WHEEL CONTROL

The wheel control is ensured by a wired control connected to the ez-Box wireless interface

02

WIRED CONTROLS
 Page 28



SWITCHES
 Page 29



03

SWITCH USE

A switch can be used to start and stop the system

Cables

Cables for **Wireless interface ez-Box ezR44IN/W**

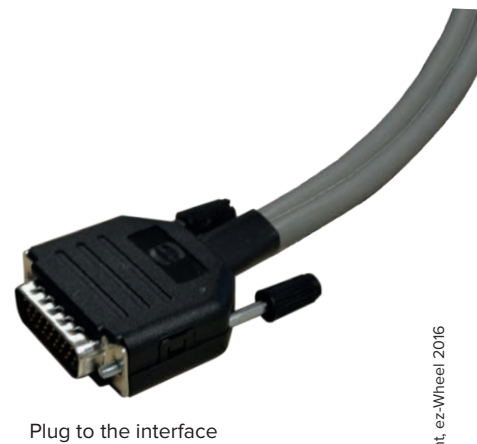

with SERIAL LINK

The serial link is used in ez-Wheel solutions for insuring a wired communication recommended for noisy environments or wireless restricted areas.

Serial ez-Box	
Communication	Serial
Battery	Ni-MH rechargeable
Dimensions	124 x 75 x 27 mm

WHEELS
ezW300I/CC
Page 08

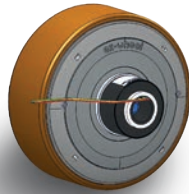

CHARGER
Page 30 - 31

01 WIRED COMMUNICATION
The wired communication uses a serial protocol to ensure an effective bi-directional dialogue between the wheel and the ez-Box

02 Suitable with ezW300I/CC
The Serial link is suitable to control one wheel Series 300/CC featuring cable connect



Ref. ezR44IN/U
Suitable for:
• Series 300/CC

03 DOUBLE RECHARGE
The wired connection allows recharging the wheel and the ez-Box at the same time, using a standard charger and a Y cable

WIRED CONTROLS
Page 28

SWITCHES
Page 29

Cables

Cable for **Serial link ez-Box**



Cable x Meters for Wired Control with Charge Plug for ez-Box
Ref. ezACxM-UC/Box



Cable x Meters for Wired Control and Button with Charge Plug for ez-Box
Ref. ezACxM-UCB/Box

Charge Cables for **all chargers**



Y charge cable with Serial link
Ref. ezCYC-U
Suitable for:
• All chargers



Charge cable extender with Serial link
Ref. ezCCxM-U
Suitable for:
• All chargers



Plug to the wired control



Plug to the switch/button



Plug to the charger



Plug to the interface

Series 160 - Controls and Accessories

The Modular Solution

The self-propelled ez-Wheel can be fitted immediately on any vehicle chassis or mobile equipment. The wheel is self-powered by the built-in battery and driven by wired controls.



WHEEL CONTROL

The wheel control is ensured by a wired control connected to the back of the wheel

01

WIRED
CONTROLS
Page 28



SWITCHES
Page 29



SWITCH USE

A switch with optional display can be used to start and stop the system

03

Cables

Cables for **Series 160**



Cable x Meters for wired control and button & Display
Ref. ezACxM-BD/160



Charge cable
Ref. ezCCxM/160

For external batteries and power output cables, please refer to page 33.



Plug to the wired control



Plug to the button



Plug to the charger

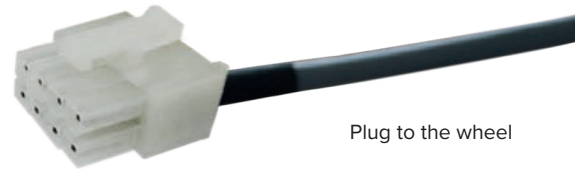



Plug to the wheel





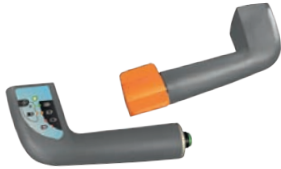

Charge plug to the wheel

Wired Controls

Hand controls **with Switch** ▲▼



VIEW	DESIGNATION	CHARACTERISTICS	WIRED TO
	Rotating Handle with Button & Display ▲▼ ezARH-BD	The ezARH-BD controls the speed in both directions (forward and backward) with a progressiveness following the hand control position. The control is equipped with a Display and a Button. • Cable required*	<ul style="list-style-type: none"> • Series 160 • ez-Box
	Tiller Head ▲▼ ezATH	The ezATH command is a tiller head type control. It ensures a proper handling of equipment thanks to ergonomic shapes and well organized commands. It can control the speed in both directions (forward and backward). For a safe action, the control includes a belly button. • Cable required*	<ul style="list-style-type: none"> • Series 160 • ez-Box

Bi-directional hand controls ▲▼



VIEW	DESIGNATION	CHARACTERISTICS	WIRED TO
	Mini joystick ▲▼ ezAARmini	This finger operated mini joystick can control the speed in both directions (forward and backward) with progressiveness. It can be mounted at the end of a tube, or on a panel. • Cable required*	<ul style="list-style-type: none"> • Series 160 • ez-Box
	Joystick ▲▼ ezAAR	The joystick can control the speed in both directions (forward and backward) with progressiveness. It can be mounted on a panel and is suitable for tough environments. • Cable required*	<ul style="list-style-type: none"> • Series 160 • ez-Box
	Forward & Backward control ▲▼ ezAFB	This simple button control is suitable for a basic forward and backward operation without progressiveness. • Cable required*	<ul style="list-style-type: none"> • Series 160 • ez-Box
	Rotating Handle ▲▼ ezARH	The ezARH controls the speed in both directions (forward and backward) with a progressiveness following the hand control position. • Cable required*	<ul style="list-style-type: none"> • Series 160 • ez-Box
	Mini Tiller Head ▲▼ ezATHmini	This compact tiller head perfectly fits small size trolleys with minimal adaptation. Equipped with a belly button, it is suitable for safe operations. • Cable required*	<ul style="list-style-type: none"> • Series 160 • ez-Box

Switches



Uni-directional controls ▲

VIEW	DESIGNATION	CHARACTERISTICS	WIRED TO
	Throttle ▲ ezAV	The ezAV control is a throttle control, as commonly found on electric bikes or scooter. It can control the speed in a single direction. • Cable included	• ez-Box
	Foot Pedal ▲ ezAFP	The foot Pedal can control the speed in a single direction. • Cable included	• ez-Box

Standard Switches**

VIEW	DESIGNATION
	Switch On/Off Button ezSONF-B • Cable required*
	Switch Key Button ezSKEY-B • Cable required*

Switches for Series 160





VIEW	DESIGNATION
	Switch On/Off Button + LED ezSONF-BD • Cable required*
	Switch Push Button Color ezSPBC-BD • Cable required*
	switch Emergency ezSEMRxM/160 • Cable included

* (Cable required) - Please refer to page 23 - 25 - 27 on this catalogue to select the appropriate cable.

** (Standard switches) - Products suitable for the complete range: Series 300 - Series 10" - Series 160

Chargers

Chargers for ez-Wheel devices

VIEW	REF.	DESIGNATION	COUNTRY PLUG EXTENSION
	Mascot1A8	CHARGER 1.8 Amp XLR charge Plug	Suitable for: <ul style="list-style-type: none"> • Series 300 • Series 10" • Series 160 with charge cable
	Mascot1A8/IP	CHARGER 1.8 Amp XLR charge Plug IP67	Suitable for: <ul style="list-style-type: none"> • Series 300 • Series 10" • Series 160 with charge cable
	Mascot4A	CHARGER 4 Amp XLR charge Plug + EU power cord (type E-F)	Suitable for: <ul style="list-style-type: none"> • Series 300 • Series 10" • Series 160 with charge cable
	Mascot1A8/160	EMBEDDED CHARGER 1.8 Amp Molex charge Plug + EU power cord (type C)	Suitable for: <ul style="list-style-type: none"> • Series 160

International Compatibility



REF.	DESIGNATION	COUNTRY PLUG EXTENSION
Mascot1A8 AUS Mascot1A8/IP AUS Mascot1A8/160 AUS	CHARGER 1.8 Amp XLR charge Plug + AUS power cord	Australia (type I)
Mascot1A8 UK Mascot1A8/IP UK Mascot1A8/160 UK	CHARGER 1.8 Amp XLR charge Plug + UK power cord	United-Kingdom (type G)
Mascot1A8 US Mascot1A8/IP US Mascot1A8/160 US	CHARGER 1.8 Amp XLR charge Plug + US power cord	United States (type A)

Charge Cables for **all** chargers



Charge Cable for **Series 160**



Extension Cable for **all** chargers



Batteries

External Batteries

REF.	DESIGNATION	PERFORMANCE	COMPATIBILITY
ezB24V6AH/L	External battery with handle Ni-Mh Long life	24V 6Ah	Suitable for: <ul style="list-style-type: none"> • Series 160 • Series 300/CC with converter charger
ezB24V9AH	External battery with handle Ni-Mh	24V 9Ah	Suitable for: <ul style="list-style-type: none"> • Series 160 • Series 300/CC with converter charger
ezB24V15AH	External battery with handle Ni-Mh	24V 15Ah	Suitable for: <ul style="list-style-type: none"> • Series 160 • Series 300/CC with converter charger



External Battery
Ref. ezB24V6AH/L

Suitable for:

- Series 160
- Series 300/CC with MASCOT1A8/BAT

Cable for external battery

VIEW	DESIGNATION
	Cable for external Ni-Mh battery ez-Wheel Ref. ezBCEXM3M/160 Suitable for: <ul style="list-style-type: none"> • Series 160

Converter charger

VIEW	DESIGNATION
	Converter to recharge internal battery from ez-Wheel battery Ref. MASCOT1A8/BAT Suitable for: <ul style="list-style-type: none"> • Series 160 • Series 300/CC

Battery cables for **Series 160**



Cable for 24V power output
Ref. ezBC24V/160
Suitable for:
• Series 160



Cable for universal external battery*
Ref. ezBCEXT/160
Suitable for:
• Series 160

Additional battery for **Series 160**

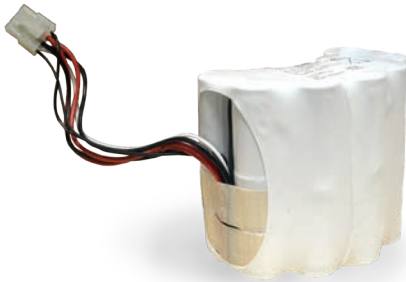

Additional internal battery
Ref. ezB24V3AH/160
Suitable for:
• Series 160

* Consult ez-Wheel to get battery specification

Mechanical Accessories

Accessories for Series 300 et 10''

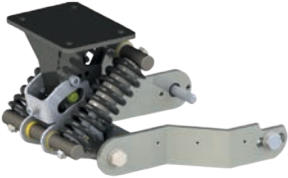

VIEW	DESIGNATION	CHARACTERISTICS	COMPATIBILITY
	Suspension bracket ezMCS/H	The suspension bracket ezMCS/H features a suspension for height compensation. The ground contact is optimal and the charge on the wheel stays stable, ensuring a good grip for the torque transmission.	• Series 300
	Fixed bracket ezMCF/300	The ezMCF/300 fixed bracket facilitates the assembly of Series 300 wheels on rolling material (trucks, trolleys, handling tools...). The bracket is designed to immediately fit the wheel on any chassis.	• Series 300
	Fixed bracket ezMCF/10	The ezMCF/10 fixed bracket facilitates the assembly of Series 10'' wheels on rolling material (trucks, trolleys, handling tools...). The bracket is designed to immediately fit the wheel on any chassis.	• Series 10''
	Anti-rotate ring ezMAR	The ezMAR is used to block the rotation of the wheel's axis, ensuring the transmission of the motor torque to the chassis.	• Series 300 • Series 10'' • Series 300/CC

Accessories for Series 300/CC

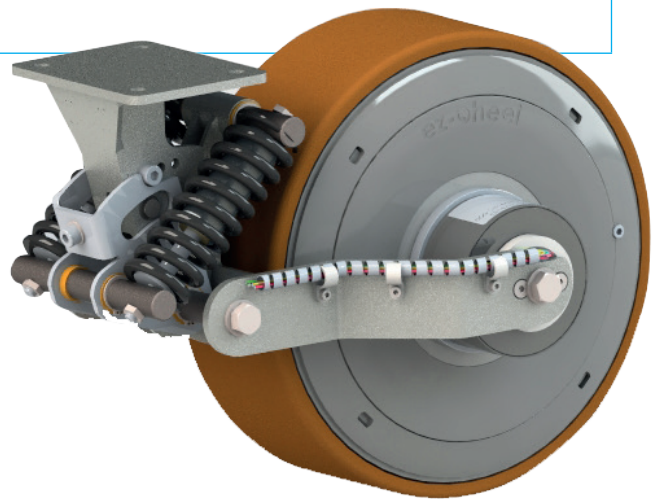
VIEW	DESIGNATION	CHARACTERISTICS	COMPATIBILITY
	<p>Horizontal suspension bracket ezMCS/H/CC</p>	<p>The suspension bracket ezMCS/H/CC is a specific version of the ezMCS/H for the Series 300/CC wheels. It includes collars to attach the wheel's cable output.</p>	<ul style="list-style-type: none"> • Series 300/CC

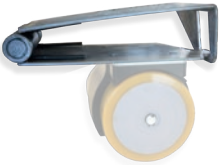

Accessories for Series 160

VIEW	DESIGNATION	CHARACTERISTICS	COMPATIBILITY
	<p>Horizontal suspension bracket ezMCS/160</p>	<p>The suspension bracket ezMCS/160 features a suspension for height compensation. The ground contact is optimal and the charge on the wheel stays stable, ensuring a good grip for the torque transmission.</p>	<ul style="list-style-type: none"> • Series 160
	<p>Horizontal suspension bracket ezMCS/L/160</p>	<p>The suspension bracket ezMCS/L/160 features a suspension for height compensation. The ground contact is optimal and the charge on the wheel stays stable, ensuring a good grip for the torque transmission.</p>	<ul style="list-style-type: none"> • Series 160



Intertek

FRANCE
0027313-00

ISO 9001
v.2008



ez-Wheel SAS

PTE du Grand Girac - Rue Jean Doucet

16470 Saint Michel - FRANCE

info@ez-wheel.com

+33 (0)5 31 61 55 80

www.ez-wheel.com