

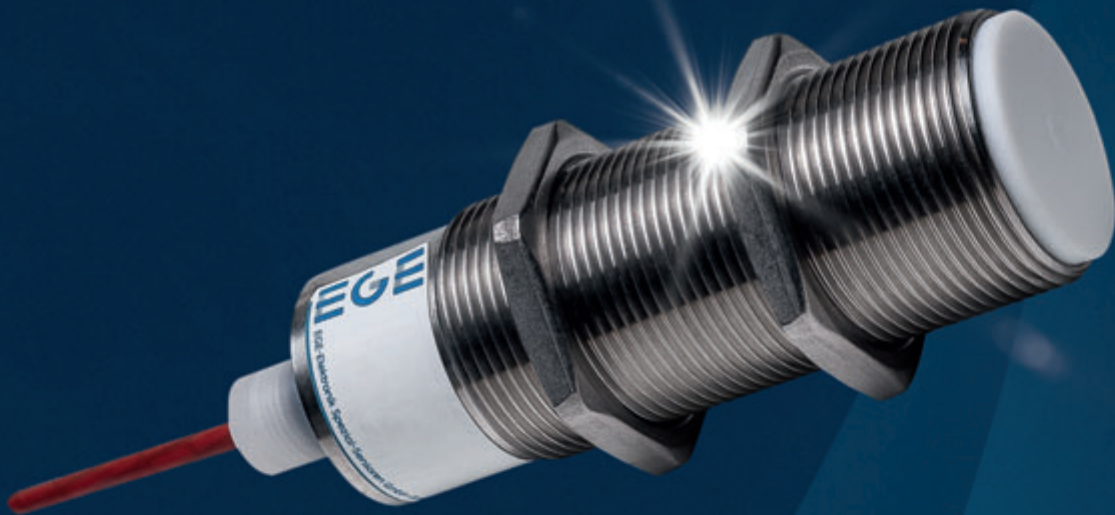

# Inductive Sensors



Special-Sensors for Automation

# Inductive Sensors

## Contents

### Technique and application for Inductive Sensors

Application notes	3.3
Terminology for inductive measurement	3.4 - 3.6

### Extreme environment

Metal face sensors Series IGV / IGVU...-C / IGVW	3.8 - 3.11
Mounting clamp for metal face sensors Series KBM	3.12
POLAR-Series climatic-proofed -60 °C Series IGMP / -80 °C Series IGMP	3.13 - 3.15
TROPICAL-Series climatic proofed 120 °C Series IGMF / IGMW	3.16 - 3.21
TROPICAL-Series resistant to cooling fluids 120 °C Series IGFW / INFW	3.22 - 3.23
TROPICAL-Series resistant to cooling fluids armoured cable Series IGMF / INFW	3.24 - 3.25
High temperature 120 °C Series IGMT / Series IDT	3.26 - 3.28
High temperature 160 °C Series IGMH	3.29 - 3.30
High temperature 250 °C Series IGH / IRH / IDH	3.31 - 3.32
High temperature 200 °C Series INT	3.33
Amplifiers for high temperature sensors Series IKM / IU	3.34 - 3.35

### Demanding environment

Metal sleeve M12 / M18 / M30 Series IGM	3.36 - 3.39
Long sensing range Ø 80 mm / Ø 105 mm / Ø 160 mm / Ø 200 mm Series ID	3.40 - 3.43

### Analogserie

Metal sleeve M12 / M18 / Series IGA	3.44 - 3.45
Long sensing range Ø 80 mm Series IDA	3.45
High temperature 160 °C Series IGT	3.46

### Standard switches

Metal sleeve M12 / M18 / M30 Series IGM	3.47 - 3.48
Smooth-bodied switches Ø 20 mm / Ø 34 mm Series INK	3.49

### Special functions

Surface sensors Series IFE	3.50
Offshore Series IGMO / Series IGVO	3.51 - 3.52
Washing resistant Series IDKW	3.53
Factor 1 Series IGB / IDB	3.54
Speed sensor Series HGVH	3.55

### Inductive Sensors for Ex-applications

Dust / Gas-Ex compact model Zone 0/20 Series IGEX20a / IGEX20Pa	3.58 - 3.59
Dust / Gas-Ex intrinsically safe Zone 0/20 Series IGEXUa / IGEXa	3.60 - 3.61
Dust / Gas-Ex intrinsically safe Zone 0/20 Series IGEXHa	3.62
Dust / Gas-Ex intrinsically safe Zone 0/20 Series IGEXPa	3.63
Dust / Gas-Ex compact model 2/22 Series IGEX22c / IGVEX22c	3.64 - 3.66
Ex-Amplifiers Series IKMb 122 Ex / IKMb 123 Ex	3.67 - 3.68

### Accessories

M12 connector	3.69
PG plug system	3.70
Assembly parts	3.71

Technical alterations are reserved to us without prior announcement. The information provided in this catalogue is for reference only. Product installation information can be found in the instructions supplied with each product.

# Inductive Sensors

## Application notes

### Sensors

#### Page 3.08–3.11

##### **Metal face sensors**

The inductive proximity switches series IGV are used in areas with heavy-duty mechanical loads at the sensor's face or where seals between face and housing cannot be used. Chips hitting the front or frequently changing coolants or lubricants do not diminish the function of these proximity switches. The variants with a PTFE coating are particularly well-suited for welding lines and similar environments where sensors are exposed to heavy soiling. Metal face switches are manufactured from stainless steel and are one solid piece. They detect iron and steel through the metal front face.

#### Page 3.13–3.15

##### **POLAR-Switches**

The POLAR-switch is ideal for application in cold storage houses and in extreme climate conditions. It is water-proof, safe for cleaning and extremely chemical-resistant. Because of its stainless steel housing, it can withstand vibrations on vehicles. The POLAR-switch is very compact and robust, it can be used from  $-60\text{ °C}$  to  $+60\text{ °C}$ . IGMP 030 S-80 sensors are suitable in cryogenic processes and for medical-technical applications; they can be used for temperatures up to  $-80\text{ °C}$ .

#### Page 3.16–3.21

##### **TROPICAL-Switches**

The TROPICAL switches series IGMF are anticipated for applications in corrosive environment. They are stable particularly at frequent temperature changes and simultaneously high humidity. The permanent work in carwashes is permissible. The high corrosion resisting at simultaneously high mechanical loading capacity is reached through the combination of PTFE and titan stabilized stainless steel. The PTFE-hoods are sealed through fluoroelastomers O-rings surely. The FEP-connecting cable is poured within the housing and freed over a double seal from the housing. Cable lengths up to 100 m are available. The installed LED's are shining through the cable side cap and don't break out the case. IGMW series sensors are suitable for hydro steam environ-

ments with pressures of up to 4 bars. For higher pressures in hydro steam environments, IGWW series sensors made of full stainless steel are recommended.

#### Page 3.22–3.28

##### **120 °C-High temperature switches**

The inductive PTFE switches series IGFW and INFW are made entirely of PTFE. The housing cover is securely sealed with a fluoroelastomer O-Ring. These sensors are designed for particularly difficult and aggressive environmental conditions. They can be used in damp and aggressive environments as well as under water (oil). IGMT- and IDT-series proximity switches are designed for use in temperatures up to  $120\text{ °C}$ .

#### Page 3.29–3.30

##### **160 °C-High temperature switches**

Inductive compact devices for ambient temperatures up to  $160\text{ °C}$  are available flush and non-flush in the standard designs M12, M18 and M30 with switching distances from 2 mm to 15 mm. The material used is the rugged stainless steel housing combined with high temperature resistant PEEK plastic.

#### Page 3.31–3.32

##### **250 °C-High temperature sensors**

The inductive proximity switches series IGH/IDH/IRH are used for ambient temperatures up to  $250\text{ °C}$ . The units feature optional a plug connection which withstands high temperatures, allowing users to quickly and easily install a replacement sensor head in case of damage without having to replace the sensor cable. The sensors are particularly suited for operation in extreme heat, e. g. in drying ovens or brick kilns. Manufactured from aluminum / stainless steel and PEEK, the robust sensors can be used in rugged industrial environments. Their electronics are housed separately in a plug-gable cable amplifier. The units are connected via a metal armored cable.

#### Page 3.34–3.35

##### **Amplifiers**

Switching amplifiers are designed for induction sensors for which it is necessary to separate the sensor coil from the amplifier, e. g. for operating tem-

peratures above  $160\text{ °C}$  or for sensor coils which must be exchanged due to frequent damage. The switching amplifiers work statically, that is, if the sensor coil is permanently damped, the switching output also remains activated. Switching interval and hysteresis (IKM 120 GPP, IU 130...) can be set on the amplifier. The sensor cable may have a length of up to 20 m.

#### Page 3.36–3.43

##### **Demanding environment**

The "Demanding environment" series is especially designed for harsh environments in which sensors are subjected to high electrical, electromagnetic or mechanical stress. For sensors used in critical applications, EGE has developed special inspection and test methods which place particular emphasis on the disturbances that occur in various production environments. The sensors are designed to be very resistant to the interference spectra produced by, e. g., frequency inverters, wireless communication systems and switching power supplies.

#### Page 3.50

##### **Surface sensors IFE...**

The switches are built as flat sensors. They are used particularly to detect moving sheet metal or steel rods on conveyor belts. The complete sensor is covered, which make the sensor moisture resistant. Reduced overall height affects the operating distance (sn). The IFE switches are self-contained with integral amplifier.

#### Page 3.58–3.68

##### **Dust- and Gas-Ex sensors**

Series IGEXa..., IGEX20a... and IGEX22c... are sensors for detecting metals in the Ex area zone 0/20 and zone 2/22 according to ATEX and IECEx. Devices can be delivered in the standard configurations M12, M18 and M30. For extreme environment sensors are available for high and low temperatures (up to  $+140\text{ °C}$  and down do  $-60\text{ °C}$  respectively), both in IP 68/IP 69.

# Inductive Sensors

## Technique & Application

### Terminology

#### Operating principal

An inductive proximity switch works with a high frequency oscillating circuit that creates an alternating electromagnetic field on the active sensor surface by means of a coil. When a metallic object nears this field a damping occurs in the oscillating circuit. If this damping exceeds a threshold value, a switching signal is generated.

#### Operating distance

The operating distance is the distance between an object and the active sensor surface at which a switching signal is generated. The operating distance depends on the diameter of the coil. Therefore larger sensors are required for longer operating distances. On some of the EGE sensors the operating distance is adjustable.

If a metal object dampens only a part of the alternating field, the operating distance decreases; a larger object increases it. The following approximate values are derived from a standard rectangular measurement plate made of steel ST 37 with an edge length that corresponds to the diameter of the sensor coil or three times the rated operating distance, whichever is greater.

Damping area in %					
150	100	75	50	25	12,5
Operating distance in %					
110	100	93	86	73	55

The operating distance is influenced by the material of the object: Constant dimensions for different materials against steel ST 37 yield a changed operating distance.

The following table lists approximate values for the material dependent reduction factors. In practical applications variations could occur due to different alloying, for example.

Material	Operating distance in %
Stell ST37	100
Stainless steel	70
Brass (Br)	50
Copper (Cu)	45
Aluminium (Al)	40

#### Rated operating distance $s_n$

The rated operating distance is a device parameter that does not take into account sample variances and external influences such as temperature and supply voltages.

#### Effective operating distance $s_r$

The effective operating distance is the operating distance at nominal voltage and a nominal temperature of 23 °C. It is between 90% and 110% of the rated operating distance.

#### Usable operating distance $s_u$

The usable operating distance lies in the entire allowable temperature and voltage range between 90% and 110% of the effective operating distance.

#### Assured operating distance $s_a$

The assured operating distance takes into account all the external influences and sample variances and lies in the range from 0% to 80% of the usable operating distance. Within this range a guaranteed switching is ensured.

#### Switch point drift

The operating distances are given for an ambient temperature of 23 °C. In the permissible temperature range the operating distance varies by less than 15% from the value at 23 °C. The temperature of the measured object has no influence on the switch point.

#### Hysteresis H

The switching hysteresis describes the distance between the turn-on point while approaching an object and the turn-off point during the separation of it from the sensor. The hysteresis brings about a stable switching signal even when there are vibrations, temperature drift, or electrical variations. The hysteresis is defined in EN 60947-5-2 as a maximum 20% from the effective operating distance, and carries a value of typically 10% from the effective operating distance  $s_r$  for EGE sensors.

#### Repeating accuracy R

The repeating accuracy describes the maintenance of the switching point after the repeated approach of an object under specified circumstances. EGE sensors have typical tolerances of less than 3% of the effective operating distance.

#### Switching frequency

The maximum switching frequency of the sensor is determined at half rated operating distance  $s_n$  with standard measurement plates to EN 60947-5-2

# Inductive Sensors

## Technique & Application

### Terminology/Installation and operation

#### Operating voltage

The operating voltage is the voltage range within EGE sensors function safely. For a constant voltage supply it is important to make sure that the limits are still observed when the residual ripple is included.

#### Switching current

This current gives the maximum long-term current for the switching output of the sensor at an ambient temperature of 25 °C and ohmic load. At an elevated ambient temperature, the current load capability decreases. For analog outputs, the boundary values given in the appropriate technical data, and particularly the permissible values for resistance loads, must be observed.

#### Short circuit protection

The short circuit protection ensures the sensor against destruction through a short circuit on the output. After removal of the fault, the output is reactivated. Where a maximum overload current is listed, this should not be exceeded.

#### Excess-current release

This value indicates the median value of current at which the short circuit protection responds with a tolerance of  $\pm 20\%$ .

#### Reverse polarity protection

The reverse polarity protection prevents destruction of the sensor by a reversal of the polarity of the voltage supply.

#### Voltage drop $U_d$

The voltage drop arises at the internal resistance of semiconductor elements, which are in the current-path of the output. It is dependent of the load-current and is declared according to EN 60947-5-2 for a mean current of 50 mA.

#### Residual current $I_r$

The residual current flows in the load current circuit when the output is blocked. The residual current must be considered when switching sensors in parallel.

#### Minimum load current $I_m$

The minimum load current is necessary for flawless operation with two-wire devices.

#### Current consumption

The current consumption is the maximum value of the no-load current  $I_0$  that the sensor can absorb without a load.

#### Ambient temperature

The ambient temperature indicates the maximum allowable temperature range for the sensor.

#### Electromagnetic compatibility EMC

The EMC class is a measure of the noise immunity of the sensor against external electrical and magnetic influences. The information is based on the standard EN 61000-6-2.

#### Switch-on impulse suppression

EGE sensors have a switch-on suppression that blocks the output during the switch-on phase, when the operational voltage is applied.

#### Protective system

The protective system indicates the protection of the sensors against penetration of foreign bodies and water to EN 60529.

#### LED display

EGE sensors with yellow light-emitting diodes indicate the switching status optically.

#### Housing material

The housing material determines the chemical resistance of the sensor against external influences. For special applications, other housing materials are available.

#### Connection

The connection of the sensors is accomplished through plug-in connections or cables. Different cable types and lengths are available upon request.

#### Instructions for mounting

##### Mounting

For flush mounting the sensor can be built into metal up to its active surface without changing its characteristics. For non-flush mounting a metal-free zone around the sensor must be allowed for. A free zone to the material opposite the sensor must be maintained for all sensors.

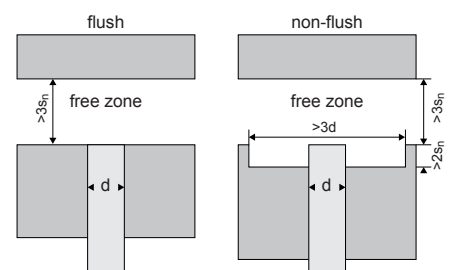

The indicated free zones are in accordance with the standard EN 60947-5-2.

Fixing nuts are part of delivery for all metal thread sensors.

For mounting clamps see page 3.71.

# Inductive Sensors

# Technique & Application

## Installation and operation

### Collocation

When collocating the sensors, a minimum separation must be kept between the devices. When in doubt, a test should be conducted under application conditions. For flush mounting the lateral separation between two sensors must correspond to at least the diameter of the sensor. For non flush mounting, the lateral separation from each other must correspond to at least twice the diameter of the sensor. For oppositely mounted sensors, a minimal separation of six times the rated operating distance should be allowed.

### Torques

In order to prevent destruction of the threaded bushing during fitting, the following maximum torques must not be exceeded:

Design	Metal housing	Plastic housing
M5x0.5	3 Nm	–
M8x1	6 Nm	0.25 Nm
M12x1	10 Nm	1 Nm
M18x1	25 Nm	2 Nm
M30x1.5	40 Nm	5 Nm

PTFE sensors may only be tightened by hand.

### Instructions for operation

#### Serial connection

For the serial connection of two wire or three wire sensors the individual voltage drops are added together. Therefore there is a lesser operational voltage at the disposal of the load. The addition of the switch-on delay times should be noted.

#### Parallel connection

The parallel connection of two wire sensors can only be conditionally recommended since the residual currents are added together and flow through the load. For the parallel connection of three wire sensors, the current consumption of the individual devices is added together. Since this current does not flow through the load, the maximum number of parallel connectable three wire sensors depends only on the power supply.

#### Approval for safety applications

Sensors for personal security must have a qualification approval according to EN 61508 and must be labeled accordingly. Sensors that are not labeled must not to be used for applications of this kind.



# Probes Compact models Amplifiers





# Metal face sensors | Plug connection

## Proximity switches

M12 / M18 / M30  
One piece stainless steel housing

DC 10...30 V

Shock resistant  
Impact proof



Design	DC PNP M12 • M18 • M30			DC 2-Wire M12 • M18 • M30					
<b>Dimensions</b>									
Operating distance sn [mm]	2	5	10	2	5	10			
Switching output PNP									
ID-No.	P31193	P31194	P31195	P31225	P31226	P31227			
Type	IGVU 02 GSP	IGVU 05 GSP	IGVU 10 GSP	IGVU 02 GS	IGVU 05 GS	IGVU 10 GS			
Supply voltage [V]	10...30 DC			8...30 DC					
Switching current [mA]	250			150					
Short circuit proof	•			•					
Reverse protection	•			•					
Voltage drop max. [V]	1.5			3.5					
Current consumption [mA]	5			1.5					
Switching frequency [Hz]	180	180	150	180	180	150			
Ambient temperature [°C]	-25...+80			-25...+80					
EMC-class	A			A					
Protection [EN 60529]	IP 68 + IP 69			IP 68 + IP 69					
LED display	•			•					
Housing material	AISI 316 L			AISI 316 L					
Connection	M12 connector			M12 connector					
The specified operating distance (sn) applies to ferromagnetic objects (ST37).									
<b>Accessories</b>	connecting cable type SLG 3-2 (Z01076), page 3.69								





## Metal face sensors | Cable connection

### Proximity switches

M12 / M18 / M30  
One piece stainless steel housing

DC 10...30 V

Shock resistant  
Impact proof



Design	DC PNP • M12x1	DC PNP • M18x1	DC PNP • M30x1.5
<b>Dimensions</b>			
Operating distance sn [mm]	2	5	10
Switching output PNP			
ID-No.	P31228	P31229	P31230
Type	IGV 02 GSP	IGV 05 GSP	IGV 10 GSP
Supply voltage [V]	10...30 DC		
Switching current [mA]	250		
Short circuit proof	•		
Reverse protection	•		
Voltage drop max. [V]	1.5		
Current consumption [mA]	max. 5		
Switching frequency [Hz]	180	180	150
Ambient temperature [°C]	-25...+80		
EMC-class	A		
Protection [EN 60529]	IP 67		
LED display	•		
Housing material	AISI 316 L		
Connection	2 m PVC-cable 3x0.34 mm <sup>2</sup>		
The specified operating distance (sn) applies to ferromagnetic objects (ST37).			



# Metal face sensors | PTFE-coated

## Proximity switches

M12 / M18 / M30  
One piece stainless steel housing

DC 10...30 V

Shock resistant  
Impact proof



Design	DC PNP • M12x1	DC PNP • M18x1	DC PNP • M30x1.5
Dimensions			
Operating distance sn [mm]	2	5	10
Switching output PNP			
ID-No.	P31234	P31235	P31236
Type	IGVU 02 GSP-C	IGVU 05 GSP-C	IGVU 10 GSP-C
Supply voltage [V]	10...30 DC		
Switching current [mA]	250		
Short circuit proof	•		
Reverse protection	•		
Voltage drop max. [V]	1.5		
Current consumption [mA]	5		
Switching frequency [Hz]	180	180	150
Ambient temperature [°C]	-25...+80		
EMC-class	A		
Protection [EN 60529]	IP 68 + IP 69		
LED display	•		
Housing material	AISI 316 L, PTFE-coated		
Connection	M12 connector		
The specified operating distance (sn) applies to ferromagnetic objects (ST37).	Design with fixed cable on request		
Accessories	connecting cable SLG 3-2 (Z01076), page 3.69		



## Metal face sensors | Climatic-protected

### Proximity switches

M12 / M18 / M30  
One piece stainless steel housing

DC 10...30 V

Shock resistant  
Impact proof



Design	DC PNP • M12x1	DC PNP • M18x1	DC PNP • M30x1.5
<b>Dimensions</b>			
Operating distance sn [mm]	2	5	10
Switching output PNP			
ID-No.	P31237	P31238	P31239
Type	IGWV 02 GSP	IGWV 05 GSP	IGWV 10 GSP
Supply voltage [V]	10...30 DC		
Switching current [mA]	250		
Short circuit proof	•		
Reverse protection	•		
Voltage drop max. [V]	1.5		
Current consumption [mA]	8		
Switching frequency [Hz]	180	180	150
Ambient temperature [°C]	-10...+110		
EMC-class	A		
Protection [EN 60529]	IP 68 + IP 69		
Housing material	AISI 316 L		
Connection	2 m FEP-cable 3x0.34 mm <sup>2</sup>		
The specified operating distance (sn) applies to ferromagnetic objects (ST37).			



# Mounting clamp | For metal face sensors

Impact- and shock resistant,  
protected installation

Simple adjustment  
via slotted holes

Mount and replace sensor  
quickly and precisely



**Design** **KBM 012 • KBM 018 • KBM 030**

*Dimensions*

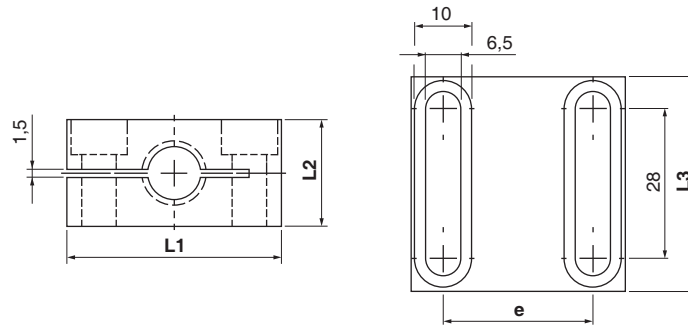

ID-No.	Z01209	Z01210	Z01211	Z01212	Z01213	Z01214
Type	KBM 012 A-ST52	KBM 018 A-ST52	KBM 030 A-ST52	KBM 012 B-A2	KBM 018 B-A2	KBM 030 B-A2
For sensor design	M12	M18	M30	M12	M18	M30
Dimensions						
L1 x L2 x L3 [mm]	34 x 24 x 40	40 x 30 x 40	55 x 40 x 40	34 x 24 x 40	40 x 30 x 40	55 x 40 x 40
Hole spacing e [mm]	20	26	40	20	26	40
Sensor installation	flushed relative to the set back surface			set back		
Housing material	ST52, hardened			AISI 303		

**Note:**  
Mounting clamps are fastened to their metal surface using M6 hexagon socket screws. Make sure that the provided stainless steel washers have been placed in-between.

The typical torque is 6 Nm.

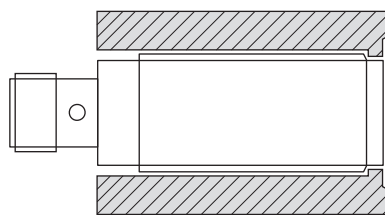

flushed relative to the set back surface

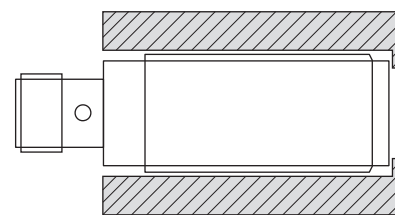

set back



**POLAR-Series DC | Climativ-proofed -60 °C**

**Proximity switches**

**M12 / M18 / M30  
Stainless steel sleeve**

**DC 10...30 V**

**IP 68 Water-proofed  
IP 69 Resistant to  
high pressure cleaning**



Design	DC PNP • M12x1		DC PNP • M18x1		DC PNP • M30x1.5	
<b>Dimensions</b>						
Installation flush (f) non flush (nf)						
Operating distance sn [mm]	2 f	4 nf	5 f	7 nf	10 f	15 nf
Switching output PNP						
ID-No.	P31145	P31146	P31147	P31148	P31219	P31220
Type	IGMP 02 GSP	IGMP 04 GSP	IGMP 05 GSP	IGMP 08 GSP	IGMP 010 GSP	IGMP 015 GSP
Supply voltage [V]	10...30 DC					
Switching current [mA]	200					
Short circuit proof	•					
Overcurrent release [mA]	230					
Reverse protection	•					
Voltage drop max. [V]	2					
Load current [mA]	-					
Current consumption [mA]	4					
Switching frequency [Hz]	1000					
Ambient temperature [°C]	-55...+60					
Temperature min. [°C]	-60					
Temperature gradient [K/min]	5					
EMC-class	A					
Protection [EN 60529]	IP 68 + IP 69					
LED display	•					
Housing material	PTFE / AISI 316 Ti					
Connection	2 m FEP-cable 3x0.34 mm²					
Switching current						



**POLAR-Series AC** | Climativ-proofed -60 °C

**Proximity switches**

**M18**  
**Stainless steel sleeve**

**AC 20...250 V**

**IP 68 Water-proofed**  
**IP 69 Resistant to high pressure cleaning**



Design	AC • M18x1	
<b>Dimensions</b>		
Installation flush (f) non flush (nf)	f	nf
Operating distance sn [mm]	5 f	7 nf
Switching output		
ID-No.	<b>P31149</b>	<b>P31150</b>
Type	IGMP 005 WS	IGMP 008 WS
Supply voltage [V]	20...250 AC	
Switching current [mA]	300	
Short circuit proof	-	
Overcurrent release [mA]	-	
Reverse protection	-	
Voltage drop max. [V]	4.5	
Load current [mA]	5	
Current consumption [mA]	2.5	
Switching frequency [Hz]	25	
Ambient temperature [°C]	-55...+60	
Temperature min. [°C]	-60	
Temperature gradient [K/min]	5	
EMC-class	A	
Protection [EN 60529]	IP 68 + IP 69	
LED display	•	
Housing material	PTFE / AISI 316 Ti	
Connection	2 m FEP-cable 3x0.75 mm <sup>2</sup>	



**POLAR-Series** | Climativ-proofed -80 °C

**Proximity switches**

**M30**  
**Stainless steel sleeve**

**IP 68 Water-proofed**

**-80 °C permanent temperature**



**Design** **M30x1.5**

*Dimensions*

Installation  
flush (f)  
non flush (nf)

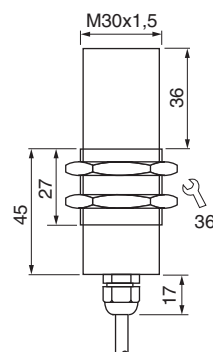

Operating distance sn [mm]	3 nf
----------------------------	------

<b>ID-No.</b>	<b>P31337</b>
Type	IGMP 030 S-80
Supply voltage [V]	-
Switching current [mA]	-
Hysteresis max. [%]	10
Short circuit proof	-
Reverse protection	-
Current consumption [mA]	-
Switching frequency [Hz]	-
Ambient temperature [°C]	-80...+50
EMC-class	A
Protection [EN 60529]	IP 68
LED display	-
Housing material	PTFE / AISI 316 Ti
Connection	2 m FEP-cable 3x0.75 mm <sup>2</sup> , shielded

Sensor for the connection  
to amplifier IKM 120...,  
see page 3.34

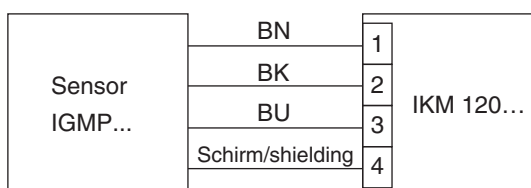



TROPICAL-Series DC | Climatic-proofed 120 °C

Proximity switches

M12 / M18-short form  
Stainless steel sleeve

DC 10...30 V

IP 68 Water-proofed  
IP 69 Resistant to  
high pressure cleaning



Design	DC PNP • M12x1		DC PNP • M18x1	
Dimensions				
Installation flush (f) non flush (nf)				
Operating distance sn [mm]	2 f	4 nf	5 f	7 nf
GSP  ID-No.	P31132	P31133	P30701	P30703
Type	IGMF 02 GSP	IGMF 04 GSP	IGMF 05 GSP	IGMF 08 GSP
GOP  ID-No.			P30702	P30704
Type			IGMF 05 GOP	IGMF 08 GOP
Supply voltage [V]	10...30 DC			
Switching current [mA]	200			
Overcurrent release [mA]	230			
Current consumption [mA]	4			
Residual current [µA]	1			
Voltage drop max. [V]	2			
Switching frequency [Hz]	1000			
Ambient temperature [°C]	-25...+120			
Compressive strength [bar]	10			
Residual ripple max. [%]	10			
EMC-class	A			
Protection [EN 60529]	IP 68 + IP 69			
Housing material	PTFE / AISI 316 Ti (A4)			
Connection	2 m FEP-cable 3x0.34 mm <sup>2</sup>			
Switching current				





# TROPICAL-Series DC | Climatic-proofed 120 °C

## Proximity switches

M18 / M30  
Stainless steel sleeve

DC 10...30 V

IP 68 Water-proofed  
IP 69 Resistant to  
high pressure cleaning



Design		DC PNP • M18x1		DC PNP • M30x1.5	
Dimensions					
	Installation flush (f) non flush (nf)				
Operating distance sn	[mm]	5 f	7 nf	10 f	15 nf
GSP	ID-No.	P31424	P31426	P31428	P31430
	Type	IGMF 005 GSP	IGMF 008 GSP	IGMF 010 GSP	IGMF 015 GSP
GOP	ID-No.	P31425	P31427	P31429	P31431
	Type	IGMF 005 GOP	IGMF 008 GOP	IGMF 010 GOP	IGMF 015 GOP
GSOP	ID-No.	P30707	P30710	P30713	P30716
	Type	IGMF 005 GSOP	IGMF 008 GSOP	IGMF 010 GSOP	IGMF 015 GSOP
Supply voltage	[V]	10...30 DC			
Switching current	[mA]	200			
Overcurrent release	[mA]	230			
Current consumption	[mA]	4			
Residual current	[µA]	1			
Voltage drop max.	[V]	2			
Switching frequency	[Hz]	1000			
Ambient temperature	[°C]	-25...+120			
Compressive strenght	[bar]	10			
EMC-class		A			
Protection	[EN 60529]	IP 68 + IP 69			
Housing material		PTFE / AISI 316 Ti (A4)			
Connection		2 m FEP-cable 3x0.34 mm <sup>2</sup> / 2 m FEP-cable 4x0.25 mm <sup>2</sup>			
Switching current					



# TROPICAL-Series AC | Climatic-proofed 120 °C

## Proximity switches

M18 / M30  
Stainless steel sleeve

AC 20...250 V

IP 68 Water-proofed  
IP 69 Resistant to high pressure cleaning



Design	AC • M18x1		AC • M30x1.5	
<b>Dimensions</b>				
Installation flush (f) non flush (nf)				
Operating distance sn [mm]	5 f	7 nf	10 f	15 nf
WS  ID-No.	P31071	P31073	P31075	P31077
Type	IGMF 005 WS	IGMF 008 WS	IGMF 010 WS	IGMF 015 WS
WO  ID-No.	P31070	P31072	P31074	P31076
Type	IGMF 005 WO	IGMF 008 WO	IGMF 010 WO	IGMF 015 WO
Supply voltage WS/WO [V]	20...250 AC			
Switching current WS/WO [mA]	< 400			
Current consumption [mA]	< 2.5			
Voltage drop max. [V]	< 5 eff.			
Switching frequency [Hz]	25			
Ambient temperature [°C]	-25...+120			
Compressive strength [bar]	10			
Minimum load current [mA]	5.0			
EMC-class	A			
Protection [EN 60529]	IP 68 + IP 69			
Housing material	PTFE / AISI 316 Ti (A4)			
Connection	2 m FEP-cable 3x0.75 mm <sup>2</sup>			
Switching current				



TROPICAL-Series DC | Climatic-proofed 120 °C

Proximity switches

M12 / M18-short form  
Stainless steel sleeve

DC 10...30 V

IP 68 Water-proofed  
IP 69 Resistant to  
high pressure cleaning  
Steam proof



Design	DC PNP • M12x1		DC PNP • M18x1	
<b>Dimensions</b>				
Installation flush (f) non flush (nf)				
Operating distance sn [mm]	2 f	4 nf	5 f	7 nf
GSP  ID-No.	<b>P31338</b>	<b>P31339</b>	<b>P31340</b>	<b>P31341</b>
Type	IGMW 02 GSP	IGMW 04 GSP	IGMW 05 GSP	IGMW 08 GSP
GOP  ID-No.			<b>P31342</b>	<b>P31343</b>
Type			IGMW 05 GOP	IGMW 08 GOP
Supply voltage [V]	10...30 DC			
Switching current [mA]	200			
Overcurrent release [mA]	230			
Current consumption [mA]	4			
Residual current [µA]	1			
Voltage drop max. [V]	2			
Switching frequency [Hz]	1000			
Ambient temperature [°C]	-25...+120			
Compressive strength [bar]	4			
Residual ripple max. [%]	10			
EMC-class	A			
Protection [EN 60529]	IP 68 + IP 69			
Housing material	PTFE / AISI 316 Ti (A4)			
Connection	2 m FEP-cable 3x0.34 mm <sup>2</sup>			
Switching current				



# TROPICAL-Series DC | Climatic-proofed 120 °C

## Proximity switches

M18 / M30  
Stainless steel sleeve

DC 10...30 V

IP 68 Water-proofed  
IP 69 Resistant to  
high pressure cleaning  
Steam proof



Design		DC PNP • M18x1		DC PNP • M30x1,5	
Dimensions					
	Installation flush (f) non flush (nf)				
Operating distance sn	[mm]	5 f	7 nf	10 f	15 nf
GSP	ID-No.	P31432	P31434	P31436	P31438
	Type	IGMW 005 GSP	IGMW 008 GSP	IGMW 010 GSP	IGMW 015 GSP
GOP	ID-No.	P31433	P31435	P31437	P31439
	Type	IGMW 005 GOP	IGMW 008 GOP	IGMW 010 GOP	IGMW 015 GOP
GSOP	ID-No.	P31352	P31353	P31354	P31355
	Type	IGMW 005 GSOP	IGMW 008 GSOP	IGMW 010 GSOP	IGMW 015 GSOP
Supply voltage	[V]	10...30 DC			
Switching current	[mA]	200			
Overcurrent release	[mA]	230			
Current consumption	[mA]	4			
Residual current	[µA]	1			
Voltage drop max.	[V]	2			
Switching frequency	[Hz]	1000			
Ambient temperature	[°C]	-25...+120			
Compressive strenght	[bar]	4			
EMC-class		A			
Protection	[EN 60529]	IP 68 + IP 69			
Housing material		PTFE / AISI 316 Ti (A4)			
Connection		2 m FEP-cable 3x0.34 mm <sup>2</sup> / 2 m FEP-cable 4x0.25 mm <sup>2</sup>			
Switching current		<p>GSP/GOP</p>		<p>GSOP</p>	



# TROPICAL-Series AC | Climatic-proofed 120 °C

## Proximity switches

M18 / M30  
Stainless steel sleeve

AC 20...250 V

IP 68 Water-proofed  
IP 69 Resistant to  
high pressure cleaning  
Steam proof



Design	AC • M18x1		AC • M30x1.5	
<b>Dimensions</b>				
Installation flush (f) non flush (nf)				
Operating distance sn [mm]	5 f	7 nf	10 f	15 nf
WS  ID-No.	P31356	P31357	P31358	P31359
Type	IGMW 005 WS	IGMW 008 WS	IGMW 010 WS	IGMW 015 WS
WO  ID-No.	P31360	P31361	P31362	P31363
Type	IGMW 005 WO	IGMW 008 WO	IGMW 010 WO	IGMW 015 WO
Supply voltage WS/WO [V]	20...250 AC			
Switching current WS/WO [mA]	< 400			
Current consumption [mA]	< 2.5			
Voltage drop max. [V]	< 5 eff.			
Switching frequency [Hz]	25			
Ambient temperature [°C]	-25...+120			
Compressive strength [bar]	4			
Minimum load current [mA]	5.0			
EMC-class	A			
Protection [EN 60529]	IP 68 + IP 69			
Housing material	PTFE / AISI 316 Ti (A4)			
Connection	2 m FEP-cable 3x0.75 mm <sup>2</sup>			
Switching current				



# TROPICAL-Series DC | Resistant to rolling oil

Proximity switches

PTFE housing

DC 10...30 V

IP 68 Water-proofed  
IP 69 Resistant to high pressure cleaning



Design	DC PNP • M30x1.5				DC • Ø 35
Dimensions					
Installation flush (f) non flush (nf)					
Operating distance sn [mm]	10 f	10 f	14 nf	14 nf	19 nf
Switching output (DC PNP)					
ID-No.	P31440	P31455	P31441	P31456	P31442
Type	IGFW 010 GSP	IGFW 010 GOP	IGFW 015 GSP	IGFW 015 GOP	INFW 020 GSP
Supply voltage [V]	10...30 DC				
Switching current [mA]	< 200				
Surge current [mA]	short circuit protection				
Current consumption [mA]	4				
Inverse current max. [µA]	1				
Voltage drop [V]	2				
Ambient temperature [°C]	-25...+120				
Temperature deviation [%]	10 (-25...+70 °C), 20 (-25...+120 °C)				
Overcurrent release approx. [mA]	230				
Reverse Protection	•				
Minimum load current [mA]	-				
EMC-class	A				
Switching frequency [Hz]	1000				500
Protection [EN 60529]	IP 68 + IP 69				
Housing material	PTFE				
Connection	2 m FEP-cable 0.34 mm <sup>2</sup>				
Switching current					
Accessories	nut M30x1.5 (Z00120), clamp Ø 35 (Z00125), page 3.71				

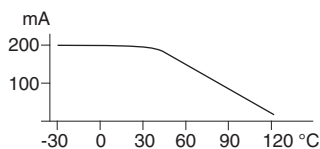



## TROPICAL-Series AC | Resistant to rolling oil

Proximity switches

PTFE housing

AC 20...250 V

IP 68 Water-proofed

IP 69 Resistant to  
high pressure cleaning



Design	AC • M30x1.5		AC • Ø35
<b>Dimensions</b>			
Installation flush (f) non flush (nf)			
Operating distance sn [mm]	10 f	14 nf	19 nF
Switching output			
ID-No.	P30626	P30638	P30650
Type	IGFW 010 WS	IGFW 015 WS	INFW 020 WS
Supply voltage [V]	20...250 AC		
Switching current [mA]	< 400		
Current consumption [mA]	2.5		
Voltage drop [V]	5 eff.		
Switching frequency [Hz]	20		
Ambient temperature [°C]	-25...+120		
Temperature deviation [%]	10 (-25...+70 °C), 20 (-25...+120 °C)		
Minimum load current [mA]	5.0		
EMC-class	A		
Protection [EN 60529]	IP 68 + IP 69		
Housing material	PTFE		
Connection	2 m Silicone-cable 0.75 mm <sup>2</sup>		
Switching current			
Accessories	nut M30x1.5 (Z00120), clamp Ø35 (Z00125), page 3.71		



# TROPICAL-Series | Resistant to rolling oil

Proximity switches

DC 10...55 V

Climatic-proofed  
Resistant to acid

Armoured cable  
with IP 68-plug



Design	DC PNP • M30x1.5	DC PNP • Ø 35
Dimensions		
Installation flush (f) non flush (nf)	LED	LED
Operating distance sn [mm]	10 f	20 nf
Switching output PNP		
ID-No.	P31443	P31444
Type	IGMF 010 GSP-PZ	INFW 020 GSP-PZ
Supply voltage [V]	10...30 DC	10...30 DC
Switching current max. [mA]	200	200
Current consumption [mA]	4	4
Switching frequency [Hz]	1000	500
Ambient temperature [°C]	-25...+120	-25...+120
Compressive strength [bar]	10	-
Protection [EN 60529]	IP 68 + IP 69	IP 68 + IP 69
Function indicator	LED	LED
Housing material	PTFE, AISI 316 Ti	PTFE
Connection	5 m FEP-cable 3x0.34mm <sup>2</sup> armoured cable	5 m FEP-cable 3x0.34mm <sup>2</sup> armoured cable
Plug, Lemo series K, 3-pol		
Sensors without plug on request		
Accessories	junction box GS..., page 3.25	





# Junction box | Resistant to rolling oil

Connection of sensors with armoured cable

IP 68-plug



Design	GS 125	GS 175	GS 250
<b>Dimensions</b>			
ID-No.	P31212	P31217	P31218
Type	GS 125	GS 175	GS 250
Connectable sensors	2	3	4
Supply voltage [V]	10...55 DC	10...55 DC	10...55 DC
Ambient temperature [°C]	-20...+75	-20...+75	-20...+75
Protection [EN 60529]	IP 68	IP 68	IP 68
Housing material	Aluminium	Aluminium	Aluminium
Connection	10 m TPE-numbered cable 7x0.5mm <sup>2</sup>	10 m TPE-numbered cable 7x0.5mm <sup>2</sup>	10 m TPE-numbered cable 7x0.5mm <sup>2</sup>

Plug, Lemo series K, 3-pol

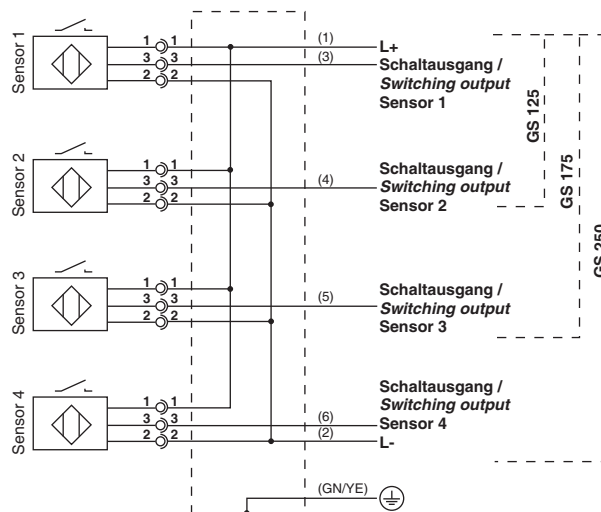
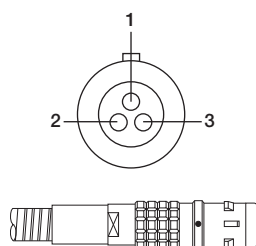

Notice

for sensors IGMF 010 GSP-PZ / INFW 020 GSP-PZ, page 3.24



# High temperature 120 °C | DC

## Proximity switches

M12 / M18 / M30  
Metal sleeve

DC 10...48 V

Extended  
temperature range  
-25 °C...+120 °C



Design	DC PNP • M12x1		DC PNP • M18x1		DC PNP • M30x1.5	
<b>Dimensions</b>						
Installation flush (f) non flush (nf)						
Operating distance sn [mm]	2 f	4 nf	5 f	8 nf	10 f	15 nf
Switching output PNP						
ID-No.	P31282	P31283	P31290	P31291	P31292	P31293
Type	IGMT 02 GSP	IGMT 04 GSP	IGMT 005 GSP	IGMT 008 GSP	IGMT 010 GSP	IGMT 015 GSP
Supply voltage [V]	10...48 DC					
Switching current [mA]	200					
Short circuit proof	•					
Reverse protection	•					
Voltage drop max. [V]	2					
Current consumption [mA]	4					
Switching frequency [Hz]	500					
Ambient temperature [°C]	-25...+120					
EMC-class	A					
Protection [EN 60529]	IP 67					
LED display	•					
Housing material	Br-Ni / PBT					
Connection	2 m Silicone-cable 3x0.34 mm <sup>2</sup>					
Switching current						
Notes	design with M12 connector on request					



# High temperature 120 °C | AC

## Proximity switches

M18 / M30  
Metal sleeve

AC 20...250 V

Extended  
temperature range  
-25 °C...+120 °C



Design	AC • M18x1		AC • M30x1.5	
<b>Dimensions</b>				
Installation flush (f) non flush (nf)				
Operating distance sn [mm]	5 f	8 nf	10 f	15 nf
Switching output				
ID-No.	P31118	P31119	P31120	P31121
Type	IGMT 005 WS	IGMT 008 WS	IGMT 010 WS	IGMT 015 WS
Supply voltage [V]	20...250 AC			
Switching current [mA]	200			
Short circuit proof	-			
Reverse protection	-			
Voltage drop max. [V]	5 eff.			
Minimum load current [mA]	5			
Current consumption [mA]	2.5			
Switching frequency [Hz]	25			
Ambient temperature [°C]	-25...+120			
EMC-class	A			
Protection [EN 60529]	IP 67			
LED display	•			
Housing material	Br-Ni / PBT			
Connection	2 m Silicone-cable 3x0.75 mm <sup>2</sup>			
Switching current				



# High temperature 120 °C | AC / DC

## Proximity switches

DC 10...55 V  
AC 20...250 V

Extended sensing range

Extended temperature range  
-25 °C...+120 °C



Design	Ø 80 mm		Ø 105 mm		Ø 160 mm	
<b>Dimensions</b>						
<b>Installation non flush (nf)</b>						
<b>Operating distance sn [mm]</b>	50 nf	45 nf	80 nf	60 nf	110 nf	100 nf
<b>Switching output (DC PNP)</b>						
<b>ID-No.</b>	P31276	P31279	P31277	P31280	P31278	P31281
<b>Type</b>	IDT 080 GSP	IDT 080 WS	IDT 105 GSP	IDT 105 WS	IDT 160 GSP	IDT 160 WS
<b>Supply voltage [V]</b>	10...55 DC	20...250 AC	10...55 DC	20...250 AC	10...55 DC	20...250 AC
<b>Switching current [mA]</b>	400	400	400	400	400	400
<b>Short circuit proof</b>	•	-	•	-	•	-
<b>Reverse protection</b>	•	-	•	-	•	-
<b>Voltage drop max. [V]</b>	2	5 eff.	2	5 eff.	2	5 eff.
<b>Minimum load current [mA]</b>	-	5	-	5	-	5
<b>Current consumption [mA]</b>	4	2.5	4	2.5	4	2.5
<b>Switching frequency [Hz]</b>	20	10	20	10	20	10
<b>Ambient temperature [°C]</b>	-25...+120					
<b>EMC-class</b>	A					
<b>Protection [EN 60529]</b>	IP 67					
<b>Housing material</b>	PBT / Aluminium					
<b>Connection</b>	2 m Silicone-cable 3x0.34 mm <sup>2</sup>	2 m Silicone-cable 2x0.75 mm <sup>2</sup>	2 m Silicone-cable 3x0.34 mm <sup>2</sup>	2 m Silicone-cable 2x0.75 mm <sup>2</sup>	2 m Silicone-cable 3x0.34 mm <sup>2</sup>	2 m Silicone-cable 2x0.75 mm <sup>2</sup>
<b>Switching current</b>						



# High temperature 160 °C | DC

## Proximity switches

M12 / M18 / M30  
Stainless steel sleeve

DC 10...30 V

IP 68 Water-proofed  
IP 69 Resistant to  
high pressure cleaning



Design	DC PNP • M12x1		DC PNP • M18x1		DC PNP • M30x1.5	
<b>Dimensions</b>						
Installation flush (f) non flush (nf)						
Operating distance sn [mm]	2 f	4 nf	5 f	8 nf	10 f	15 nf
Switching output PNP						
ID-No.	P31288	P31289	P31161	P31162	P31163	P31164
Type	IGMH 02 GSP	IGMH 04 GSP	IGMH 005 GSP	IGMH 008 GSP	IGMH 010 GSP	IGMH 015 GSP
Supply voltage [V]	10...30 DC					
Switching current [mA]	200					
Short circuit proof	•					
Reverse protection	•					
Voltage drop max. [V]	2					
Residual current max. [mA]	0.02					
Current consumption (not actuated) [mA]	7					
Switching frequency [Hz]	200					
Temperature deviation [%]	15					
Ambient temperature [°C]	-25...+150			-25...+160		
EMC-class	A					
Protection [EN 60529]	IP 68 + IP 69					
LED display	-					
Housing material	AISI 316 Ti / PEEK					
Connection	2 m FEP-cable 3x0.34 mm <sup>2</sup>					

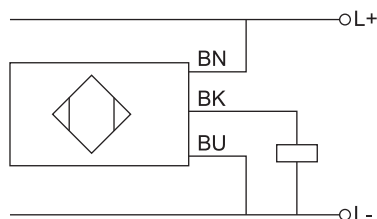
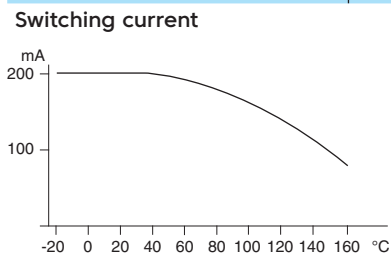

Notes temperature depending parameters are described in the technical manual



# High temperature 160 °C | DC

## Proximity switches

M12 / M18 / M30  
Stainless steel sleeve

DC 10...30 V

Moisture resistant  
Silicone-cable



Design	DC PNP • M12x1		DC PNP • M18x1		DC PNP • M30x1.5	
<b>Dimensions</b>						
Installation flush (f) non flush (nf)						
Operating distance sn [mm]	2 f	4 nf	5 f	8 nf	10 f	15 nf
Switching output PNP						
ID-No.	P31299	P31300	P31301	P31302	P31303	P31304
Type	IGMH 02 GSP-K	IGMH 04 GSP-K	IGMH 005 GSP-K	IGMH 008 GSP-K	IGMH 010 GSP-K	IGMH 015 GSP-K
Supply voltage [V]	10...30 DC					
Switching current [mA]	200					
Short circuit proof	•					
Reverse protection	•					
Voltage drop max. [V]	2					
Residual current max. [mA]	0.02					
Current consumption (not actuated) [mA]	7					
Switching frequency [Hz]	200					
Temperature deviation [%]	15					
Ambient temperature [°C]	-25...+150			-25...+160		
EMC-class	A					
Protection [EN 60529]	IP 67					
LED display	-					
Housing material	AISI 316 Ti / PEEK					
Connection	2 m Silicone-cable 3x0.34 mm <sup>2</sup>					

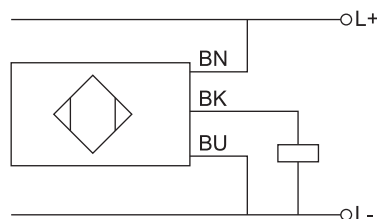
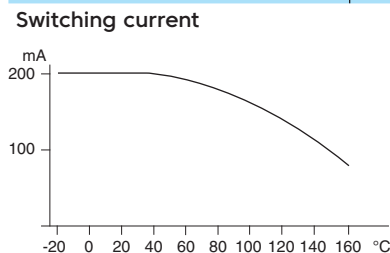

Notes temperature depending parameters are described in the technical manual



# High temperature 250 °C

Proximity sensor

Armoured cable

With connector for cable amplifier



Design	Cuboid 40 mm	Ø 80 mm	DC PNP • M30x1.5
<b>Dimensions</b>  Installation non flush (nf)			
Operating distance sn [mm]	20 nf, adjustable	40 nf, adjustable	amplifier
Switching output PNP			
ID-No.	P31294	P31295	P31204
Type	IRH 040 S250	IDH 080 S250	IK 030 GSP
Supply voltage [V]	-	-	10...30
Switching current [mA]	-	-	200
Current consumption [mA]	-	-	15
Voltage drop max. [V]	-	-	1.5
Ambient temperature [°C]	sensor: 0...+250 plug: -20...+70		0...+70
Short circuit proof	-	-	•
Reverse protection	-	-	•
EMC-class	A	A	A
Switching frequency [Hz]	30	30	30
Protection [EN 60529]	IP 60	IP 60	IP 67
Function indicator	-	-	LED yellow
Stand-by indicator	-	-	LED green
Housing material	Aluminium / PEEK		AISI 316 Ti
Connection cable	5 m FEP-cable, Ø 8 mm armoured cable		-
Connection	M12 connector		M12 connector
t x1000 [h]  Durability T [°C]			
Accessories	connecting cable SLG 3-2 (Z01076), page 3.69		



# High temperature 250 °C

Armoured cable

With connector for cable amplifier and sensor

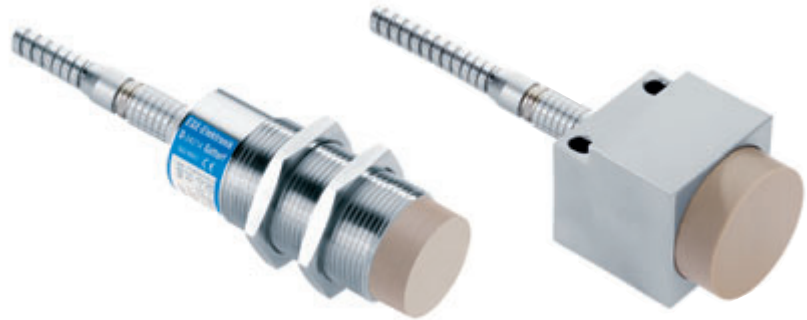

Design	M30x1.5	Cuboid 40 mm	Ø 80 mm
<b>Dimensions</b>  Installation non flush (nf)			
Operating distance sn [mm]	15 nf, adjustable	20 nf, adjustable	40 nf, adjustable
ID-No.	P31298	P31296	P31297
Type	IGHS 030 S250	IRHS 040 S250	IDHS 080 S250
Supply voltage [V]	-		
Switching current [mA]	-		
Current consumption [mA]	-		
Voltage drop [V]	-		
Ambient temperature [°C]	0...+250		
Short circuit proof	-		
Reverse protection	-		
EMC-class	A		
Switching frequency [Hz]	30		
Protection [EN 60529]	IP 60		
Housing material	AISI 316 Ti / PEEK	Aluminium / PEEK	
Connection	M12 connector		
Connection cable (Accessories)	5 m FEP-cable, Ø 8 mm armoured cable (KAP 08-DS5, Z01190)		
Accessories	connecting cable SLG 3-2 (Z01076), page 3.69		





# High temperature 200 °C

Proximity sensor

PTFE housing

No cooling



Design	INT020-S200		INT100-S180	
Dimensions				
Installation non flush (nf)				
Operating distance sn [mm]	15 nf		50 nf	
Adjustable range [mm]	5...20		10...80	
ID-No.	P31101	P30411	P31103	P30427
Type	INT020-S200 K	INT020-S200 GC	INT100-S180 K	INT100-S180 GC
Limiting temperature [°C]	250		200	
Nominal temperature [°C]	200		180	
Temperature deviation [mm/°C] (not linear)	0.05		0.06	
EMC-class	B			
Protection [EN 60529]	IP 40			
Housing material	PTFE			
Mounting	Aluminium plate			
Sensing material [ST 37]	40x40x1		100x100x1	
Connecting cable	5 m PTFE shielded			
Connection and required Amplifier	clamp connection IKM 120 GPP	plug C 16 IU 130...	clamp connection IKM 120 GPP	plug C 16 IU 130...
Special notes	If the ambient temperature exceeds 230 °C, there might be failed reactions from the sensor, but it will not be destroyed by this. The inductive high temperature proximity switches must be used with an amplifier. The connection cable can be up to 10 m long. We can supply the cable with a flexible aluminium tube on request.			
Connection diagram	Sensor-Connection sensors INT...K to IKM 120 GPP		Plug C 16: connection for Sensors INT...to IU 130...	
Amplifiers see page 3.34 - 3.35				
Temperature depending parameters are described in the technical manual				
Accessories	plug C 16			



# Amplifier

For the connection of separate sensors for extreme temperatures

LED display



**Design** **IKM 120 GSOP**

*Dimensions*

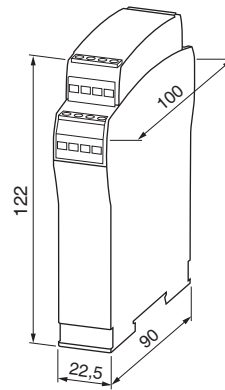

<b>ID-No.</b>	<b>P31334</b>
<b>Type</b>	<b>IKM 120 GSOP</b>
<b>Switching output</b>	 <b>PNP</b>
<b>Supply voltage [V]</b>	<b>24 V DC ±20%</b>
<b>Switching current [mA]</b>	<b>400</b>
<b>Short circuit proof</b>	<b>•</b>
<b>Current consumption [mA]</b>	<b>max. 18</b>
<b>Operating distance</b>	<b>adjustable</b>
<b>Hysteresis max. [%]</b>	<b>10</b>
<b>Switching frequency [Hz]</b>	<b>100</b>
<b>Ambient temperature [°C]</b>	<b>-25...+75</b>
<b>EMC-class</b>	<b>A</b>
<b>Protection [EN 60529]</b>	<b>terminal: IP 20 / housing: IP 40</b>
<b>Function indicator</b>	<b>LED yellow</b>
<b>Stand-by indicator</b>	<b>LED green</b>
<b>Housing material</b>	<b>PA</b>
<b>Connection sensor</b>	<b>terminal screws</b>
<b>Connection Amplifier</b>	<b>terminal screws</b>

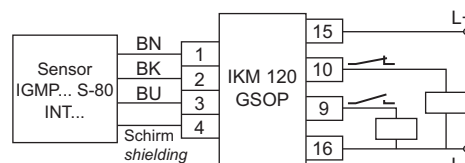



# Amplifiers

For the connection of separate sensors

LED display



**Design** IU 130...

**Dimensions**

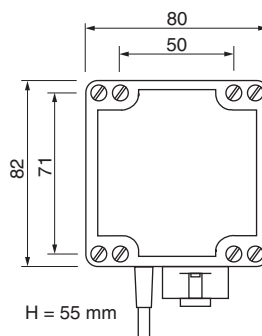

<b>ID-No.</b>	<b>P30438</b>	<b>P30439</b>
<b>Type</b>	<b>IU 130 WP</b>	<b>IU 130 GPP</b>
<b>Supply voltage [V]</b>	<b>230 AC ±10%</b>	<b>24 DC ±10%</b>
<b>Switching current [mA]</b>	<b>400</b>	
<b>Short circuit proof</b>	<b>-</b>	
<b>Current consumption [mA]</b>	<b>15</b>	
<b>Operating distance</b>	<b>adjustable</b>	
<b>Hysteresis max. [%]</b>	<b>adjustable</b>	
<b>Output</b>	<b>programmable</b>	
<b>Switching frequency [Hz]</b>	<b>5</b>	<b>15</b>
<b>Ambient temperature [°C]</b>	<b>-20...+70</b>	
<b>EMC-class</b>	<b>A</b>	
<b>Protection [EN 60529]</b>	<b>IP 67</b>	
<b>Function indicator</b>	<b>LED yellow</b>	
<b>Stand-by indicator</b>	<b>LED green</b>	
<b>Housing material</b>	<b>PBT</b>	
<b>Connection sensor</b>	<b>C 16 plug connection</b>	
<b>Connection amplifier</b>	<b>2 m PVC-cable 4x0.75 mm<sup>2</sup></b>	<b>2 m PVC-cable 3x0.50 mm<sup>2</sup></b>

connection amplifier

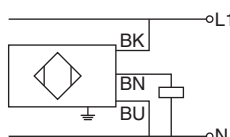

connection amplifier

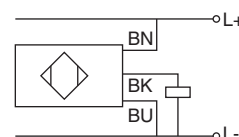

**Accessories** external plug C 16 (Z00039)



# Demanding environment

## Proximity switches

M12 / M18 / M30

Metal sleeve

DC 10...48 V

Short form

Increased EMC



Design	DC PNP • M12x1		DC PNP • M18x1		DC PNP • M30x1.5	
<b>Dimensions</b>						
Installation flush (f) non flush (nf)	flush (f)		flush (f)		flush (f)	
Operating distance sn [mm]	2 f	4 nf	5 f	8 nf	10 f	15 nf
GSP	ID-No. P31246 Type IGMU 02 GSP	ID-No. P31247 Type IGMU 04 GSP	ID-No. P31305 Type IGMU 05 GSP	ID-No. P31306 Type IGMU 08 GSP	ID-No. P31307 Type IGMU 10 GSP	ID-No. P31308 Type IGMU 15 GSP
GSOP	-	-	ID-No. P31250 Type IGMU 05 GSOP	ID-No. P31251 Type IGMU 08 GSOP	ID-No. P31254 Type IGMU 10 GSOP	ID-No. P31255 Type IGMU 15
GSOP						
Supply voltage [V]	10...48 DC					
Switching current [mA]	200					
Short circuit proof	•					
Reverse protection	•					
Voltage drop max. [V]	2					
Current consumption [mA]	2.5					
Switching frequency [Hz]	500					
Ambient temperature [°C]	-25...+75					
EMC-class	A					
Protection [EN 60529]	IP 67					
LED display	•					
Housing material	Br-Ni / PBT					
Connection	M12 connector					
Accessories	connecting cable SLG 3-2 (GSP) / SLG 4-2 (GSOP), page 3.69					



# Demanding environment

## Proximity switches

M12 / M18 / M30

Metal sleeve

DC 10...48 V

Short form

Increased EMC



Design	DC PNP • M12x1		DC PNP • M18x1		DC PNP • M30x1.5	
<b>Dimensions</b>						
Installation flush (f) non flush (nf)						
Operating distance sn [mm]	2 f	4 nf	5 f	8 nf	10 f	15 nf
GSP ID-No.	P31244	P31245	P31309	P31310	P31311	P31312
GSP Type	IGM 02 GSP	IGM 04 GSP	IGM 05 GSP	IGM 08 GSP	IGM 10 GSP	IGM 15 GSP
GSOP ID-No.	-	-	P31248	P31249	P31252	P31253
GSOP Type	-	-	IGM 05 GSOP	IGM 08 GSOP	IGM 10 GSOP	IGM 15 GSOP
Supply voltage [V]	10...48 DC					
Switching current [mA]	200					
Short circuit proof	•					
Reverse protection	•					
Voltage drop max. [V]	2					
Current consumption [mA]	2.5					
Switching frequency [Hz]	500					
Ambient temperature [°C]	-25...+75					
EMC-class	A					
Protection [EN 60529]	IP 67					
LED display	•					
Housing material	Br-Ni / PBT					
Connection	GSP: 2 m PVC-cable 3x0.34 mm <sup>2</sup>			GSOP: 2 m PVC-cable 4x0.34 mm <sup>2</sup>		

GSP

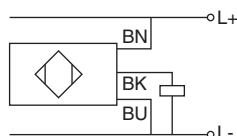

GSOP

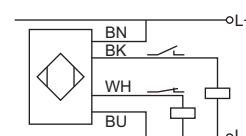



# Demanding environment

## Proximity switches

M18 / M30  
Metal sleeve

DC 10...48 V  
AC 20...250 V

Long form

Increased EMC



Design		DC PNP • M18x1	DC PNP • M30x1.5	AC • M30x1.5 programmable
Dimensions				
Installation				
Operating distance sn [mm]		5 f	8 nf	10 f
GSP		ID-No. P31313 Type IGMU 005 GSP	ID-No. P31314 Type IGMU 008 GSP	ID-No. P31315 Type IGMU 010 GSP
GSOP		ID-No. P31258 Type IGMU 005 GSOP	ID-No. P31259 Type IGMU 008 GSOP	ID-No. P31262 Type IGMU 010 GSOP
WP		ID-No. - Type -	ID-No. - Type -	ID-No. P30015 Type IGMS 010 WP
Supply voltage [V]		10...48 DC		20...250 AC
Switching current [mA]		200		400
Short circuit proof		•		3000 mA/10 ms
Reverse protection		•		-
Voltage drop max. [V]		2		6
Minimum load current [mA]		-		5
Current consumption [mA]		2.5		2.5
Switching frequency [Hz]		500		25
Ambient temperature [°C]		-25...+75		-25...+75
EMC-class		A		A
Protection [EN 60529]		IP 67		IP 67
LED display		•		•
Housing material		Br-Ni / PBT		Br-Ni / PBT
Connection		M12 connector		PG-plug connection 2 m PVC-cable 3x0.5 mm <sup>2</sup>

Accessories

connecting cable SLG 3-2 (GSP) / SLG 4-2 (GSOP), page 3.69



# Demanding environment

## Proximity switches

M18 / M30  
Metal sleeve

DC 10...48 V  
AC 20...250 V

Long form

Increased EMC



Design	DC PNP • M18x1	DC PNP • M30x1.5	AC • M30x1.5
<b>Dimensions</b>			
Installation flush (f) non flush (nf)			
Operating distance sn [mm]	5 f	8 nf	10 f
GSP	ID-No. P31317 Type IGM 005 GSP	ID-No. P31318 Type IGM 008 GSP	ID-No. P31319 Type IGM 010 GSP
GSOP	ID-No. P31256 Type IGM 005 GSOP	ID-No. P31257 Type IGM 008 GSOP	ID-No. P31260 Type IGM 010 GSOP
WS	ID-No. - Type -	ID-No. - Type -	ID-No. P30016 Type IGM 010 WS
Supply voltage [V]	10...48 DC		20...250 AC
Switching current [mA]	200		400
Short circuit proof	•		3000 mA/10 ms
Reverse protection	•		-
Voltage drop max. [V]	2		6
Minimum load current [mA]	-		5
Current consumption [mA]	2.5		2.5
Switching frequency [Hz]	500		25
Ambient temperature [°C]	-25...+75		-25...+75
EMC-class	A		A
Protection [EN 60529]	IP 67		IP 67
LED display	•		•
Housing material	Br-Ni / PBT		Br-Ni / PBT
Connection	GSP: 2 m PVC-cable, 3x0.34 mm <sup>2</sup> GSOP: 2 m PVC-cable, 4x0.34 mm <sup>2</sup>		2 m PVC-cable 3x0.5 mm <sup>2</sup>



# Demanding environment

## Proximity switches

Ø 80 mm

DC 10...55 V  
AC 20...250 V

Sensing range adjustable

Increased EMC



Design	DC PNP • Ø 80 mm	DC PNP • Ø 80 mm	AC • Ø 80 mm programmable
<b>Dimensions</b>  Installation non flush (nf)			
Operating distance sn [mm] (Adjustable range)	55 nf (25...80)	55 nf (25...80)	55 nf (25...80)
GSP  ID-No. Type	P31321 IDU 080 GSP	P31322 ID 080 GSP	-
GSOP  ID-No. Type	P31264 IDU 080 GSOP	P31265 ID 080 GSOP	-
WP  ID-No. Type	-	-	P31266 IDS 080 WP
Supply voltage [V]	10...55 DC	10...55 DC	20...250 AC
Switching current [mA]	400	400	400
Short circuit proof	•	•	3000 mA/10 ms
Reverse protection	•	•	-
Voltage drop max. [V]	2	2	6 eff.
Minimum load current [mA]	-	-	8
Current consumption [mA]	4	4	2.5
Switching frequency [Hz]	20	20	10
Ambient temperature [°C]	-25...+75	-25...+75	-25...+75
EMC-class	A	A	A
Protection [EN 60529]	IP 67	IP 67	IP 67
LED display	•	•	•
Housing material	PBT	PBT	PBT
Connection	M12 connector	GSP: 2 m PVC-cable, 3x0.5 mm <sup>2</sup> GSOP: 2 m PVC-cable, 4x0.5 mm <sup>2</sup>	PG-plug connection 2 m, 2x0.75 mm <sup>2</sup> , PVC
Accessories	connecting cable SLG 3-2 (GSP) / SLG 4-2 (GSOP), page 3.69		





# Demanding environment

## Proximity switches

Ø 105 mm

DC 10...55 V  
AC 20...250 V

Sensing range adjustable

Increased EMC

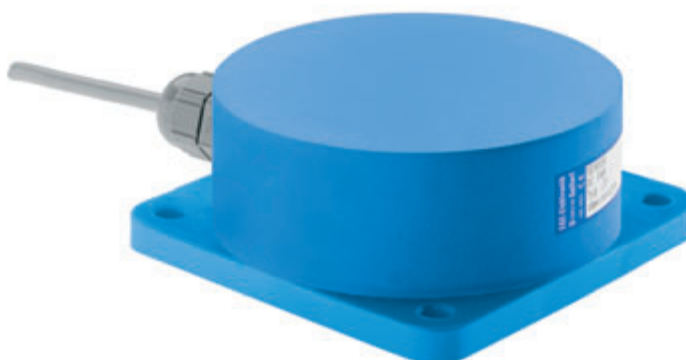

Design	DC PNP • Ø 105 mm	DC PNP • Ø 105 mm	AC • Ø 105 mm programmable
<b>Dimensions</b>  Installation non flush (nf)			
Operating distance sn [mm] (Adjustable range)	100 nf (20...110)	100 nf (20...110)	70 nf (20...110)
GSP  ID-No. Type	P31323 IDU 105 GSP	P31324 ID 105 GSP	-
GSOP  ID-No. Type	P31267 IDU 105 GSOP	P31268 ID 105 GSOP	-
WP  ID-No. Type	-	-	P31269 IDS 105 WP
Supply voltage [V]	10...55 DC	10...55 DC	20...250 AC
Switching current [mA]	400	400	400
Short circuit proof	•	•	3000 mA/10 ms
Reverse protection	•	•	-
Voltage drop max. [V]	2	2	6 eff.
Minimum load current [mA]	-	-	8
Current consumption [mA]	4	4	2.5
Switching frequency [Hz]	20	20	10
Ambient temperature [°C]	-25...+75	-25...+75	-25...+75
EMC-class	A	A	A
Protection [EN 60529]	IP 67	IP 67	IP 67
LED display	•	•	•
Housing material	PBT	PBT	PBT
Connection	M12 connector	GSP: 2 m PVC-cable, 3x0.5 mm <sup>2</sup> GSOP: 2 m PVC-cable, 4x0.5 mm <sup>2</sup>	PG-plug connection 2 m, 2x0.75 mm <sup>2</sup> , PVC
	<b>GSP</b> 	<b>GSOP</b> 	<b>WP</b> 
Accessories	connecting cable SLG 3-2 (GSP) / SLG 4-2 (GSOP), page 3.69		



# Demanding environment

## Proximity switches

Ø 160 mm

DC 10...55 V  
AC 20...250 V

Sensing range adjustable

Increased EMC



Design	DC PNP • Ø 160 mm	DC PNP • Ø 160 mm	AC • Ø 160 mm programmable
<b>Dimensions</b>  Installation non flush (nf)			
Operating distance sn [mm] (Adjustable range)	120 nf (20...150)	120 nf (20...150)	120 nf (20...150)
GSP  ID-No. P31325 Type IDU 160 GSP		P31326 ID 160 GSP	-
GSOP  ID-No. P31270 Type IDU 160 GSOP		P31271 ID 160 GSOP	-
WP  ID-No. - Type -		-	P31272 IDS 160 WP
Supply voltage [V]	10...55 DC	10...55 DC	20...250 AC
Switching current [mA]	400	400	400
Short circuit proof	•	•	3000 mA/10 ms
Reverse protection	•	•	-
Voltage drop max. [V]	2	2	6 eff.
Minimum load current [mA]	-	-	8
Current consumption [mA]	4	4	2.5
Switching frequency [Hz]	20	20	10
Ambient temperature [°C]	-25...+75	-25...+75	-25...+75
EMC-class	A	A	A
Protection [EN 60529]	IP 67	IP 67	IP 67
LED display	•	•	•
Housing material	PBT / Aluminium	PBT / Aluminium	PBT / Aluminium
Connection	M12 connector	GSP: 2 m PVC-cable, 3x0.5 mm <sup>2</sup> GSOP: 2 m PVC-cable, 4x0.5 mm <sup>2</sup>	PG-plug connection 2 m, 2x0.75 mm <sup>2</sup> , PVC
	<b>GSP</b> 	<b>GSOP</b> 	<b>WP</b> 
Accessories	connecting cable SLG 3-2 (GSP) / SLG 4-2 (GSOP), page 3.69		



# Demanding environment

Proximity switches

Ø 200 mm

DC 10...55 V  
AC 20...250 V

Sensing range adjustable

Increased EMC

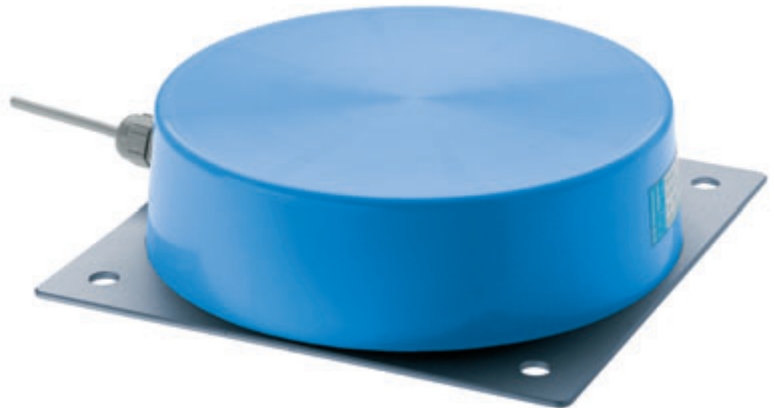

Design	DC PNP • Ø 200 mm	DC PNP • Ø 200 mm	AC • Ø 200 mm programmable
<p><b>Dimensions</b></p> <p>Installation non flush (nf)</p>			
Operating distance sn [mm] (Adjustable range)	140 nf (40...170)	140 nf (40...170)	140 nf (40...170)
GSP  ID-No. Type	P31327 IDU 200 GSP	P31328 ID 200 GSP	-
GSOP  ID-No. Type	P31273 IDU 200 GSOP	P31274 ID 200 GSOP	-
WP  ID-No. Type	-	-	P31275 IDS 200 WP
Supply voltage [V]	10...55 DC	10...55 DC	20...250 AC
Switching current [mA]	400	400	400
Short circuit proof	•	•	3000 mA/10 ms
Reverse protection	•	•	-
Voltage drop max. [V]	2	2	6 eff.
Minimum load current [mA]	-	-	8
Current consumption [mA]	4	4	2.5
Switching frequency [Hz]	20	20	10
Ambient temperature [°C]	-25...+75	-25...+75	-25...+75
EMC-class	A	A	A
Protection [EN 60529]	IP 67	IP 67	IP 67
LED display	•	•	•
Housing material	PBT / Aluminium	PBT / Aluminium	PBT / Aluminium
Connection	M12 connector	GSP: 2 m PVC-cable, 3x0.5 mm <sup>2</sup> GSOP: 2 m PVC-cable, 4x0.5 mm <sup>2</sup>	PG-plug connection 2 m, 2x0.75 mm <sup>2</sup> , PVC
	<p><b>GSP</b></p>	<p><b>GSOP</b></p>	<p><b>WP</b></p>
Accessories	connecting cable SLG 3-2 (GSP) / SLG 4-2 (GSOP), page 3.69		



# Analog output

## Proximity sensors

M12 / M18  
Metal sleeve

0...10 V  
4...20 mA



Design	M12x1	M18x1	M18x1
Dimensions			
Installation non flush (nf)			
Analog range [mm]	0...4 nf	0...5 nf	0...5 nf
Output			
ID-No.	4...20 mA P31128	0...10 V P31040	4...20 mA P31129
Type	IGA 104 GI	IGA 005 GU	IGA 005 GI
Supply voltage [V]	18...27 DC	18...27 DC	18...27 DC
Current consumption max. [mA]	40	25	40
Voltage output max. [V]	-	11	-
Output current max. [mA]	23	-	23
Linearity deviation [%]	10	5	5
Load resistance R <sub>L</sub> [kΩ]	< 0.4	> 2	< 0.4
Ambient temperature [°C]		-25...+70	
Temperature deviation [%]		10	
Protection [EN 60529]		IP 67	
Housing material		Br-Ni / PBT	
Connecting	2 m PVC-cable 3x0.34 mm <sup>2</sup>	2 m PVC-cable 3x0.5 mm <sup>2</sup>	
Output signal with approaching iron plate ST37			
Connection diagram			



# Analog output

## Proximity sensors

M30  
Ø 80 mm

0...10 V  
4...20 mA



Design	M30x1.5		Ø 80 mm	
<b>Dimensions</b>				
Installation non flush (nf)				
Analog range [mm]	0...10 nf	0...10 nf	0...30 nf	0...30 nf
Output				
	0...10 V	4...20 mA	0...10 V	4...20 mA
ID-No.	P31041	P31130	P31043	P31131
Type	IGA 010 GU	IGA 010 GI	IDA 030 GU	IDA 030 GI
Supply voltage [V]	18...27 DC	18...27 DC	18...27 DC	18...27 DC
Current consumption max. [mA]	25	40	25	40
Voltage output max. [V]	11	-	11	-
Output current max. [mA]	-	23	-	23
Linearity deviation [%]	5			
Load resistance R <sub>L</sub> [kΩ]	> 2	< 0.4	> 2	< 0.4
Ambient temperature [°C]	-25...+70			
Temperature deviation [%]	10			
Protection [EN 60529]	IP 67			
Housing material	Br-Ni / PBT		PBT	
Connection	2 m PVC-cable 3x0.5 mm <sup>2</sup>			
Output signal with approaching iron plate ST37				
Connection diagram				



# Analog | High temperature 160 °C

## Proximity sensors

M18

4...20 mA

For the connection to amplifier IKM 120 GA

Permanent temperature 160 °C

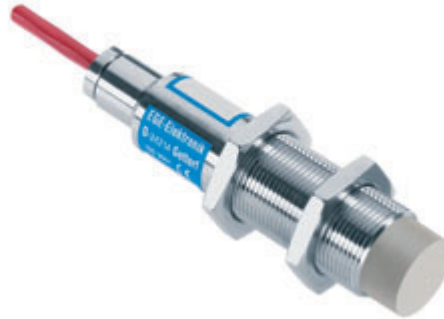

Design	IGT 005	IKM 120 GA
Dimensions		
Installation non flush (nf)		
Analog range [mm]	0...5 nf	-
ID-No.	P31143	P31144
Type	IGT 005	IKM 120 GA
Supply voltage [V]	-	24 DC ±20%
Current consumption [mA]	-	30
Current output [mA]	-	4...20 mA
Linearity [%]	6	0.5
Load R <sub>L</sub> [Ω]	-	50...500
Ambient temperature [°C]	-25...+160	-20...+60
Temperature deviation [%]	10	2
Protection [EN 60529]	IP 67	IP 40
Housing material	AISI 316 Ti / PKS	PC
Connection	2 m PTFE 3x0.75 mm <sup>2</sup>	terminal screws
Output signal with approaching iron plate ST37		
Connection diagramm		



# Standard switches

## Proximity switches

M8 / M12  
Metal sleeve

DC 10...30 V

Euronorm



Design	M8x1	DC PNP • M12x1		DC PNP • M12x1	
<b>Dimensions</b>					
Installation flush (f) non flush (nf)					
Operating distance sn [mm]	1.5 f	2 f	4 nf	2 f	4 nf
Switching output PNP					
ID-No.	P31013	P31104	P31105	P31106	P31107
Type	IGM 1 GSP	IGM 102 GSP	IGM 104 GSP	IGMU 102 GSP	IGMU 104 GSP
Supply voltage [V]	10...30 DC	10...30 DC	10...30 DC	10...30 DC	10...30 DC
Switching current [mA]	200	200	200	200	200
Short circuit proof	•	•	•	•	•
Overcurrent release [mA]	250	250	250	250	250
Reverse protection	•	•	•	•	•
Voltage drop max. [V]	2	2	2	2	2
Residual current [mA]	-	-	-	-	-
Current consumption (not actuated) [mA]	< 11	< 5	< 5	< 5	< 5
Switching frequency [Hz]	1000	800	400	800	400
Ambient temperature [°C]	-25...+70	-25...+70	-25...+70	-25...+70	-25...+70
EMC-class	A	A	A	A	A
Protection [EN 60529]	IP 67	IP 67	IP 67	IP 67	IP 67
LED display	•	•	•	•	•
Housing material	Stainless steel / PA	Br-Ni / PPO	Br-Ni / PPO	Br-Ni / PPO	Br-Ni / PPO
Connection	2 m PVC-cable 3x0.14 mm <sup>2</sup>	2 m PVC-cable 3x0.14 mm <sup>2</sup>	2 m PVC-cable 3x0.14 mm <sup>2</sup>	M12 connector	M12 connector
Accessories		connecting cable SLG 3-2, page 3.69			



# Standard switches

## Proximity switches

M18  
Metal sleeve

DC 10...30 V

Euronorm



Design	DC PNP • M18x1		DC PNP • M18x1	
Dimensions				
Installation flush (f) non flush (nf)				
Operating distance sn [mm] Switching output PNP	5 f	8 nf	5 f	8 nf
ID-No.	P31110	P31111	P31112	P31113
Type	IGM 105 GSP	IGM 108 GSP	IGMU 105 GSP	IGMU 108 GSP
Supply voltage [V]	10...30 DC	10...30 DC	10...30 DC	10...30 DC
Switching current [mA]	200	200	200	200
Short circuit proof	•	•	•	•
Overcurrent release [mA]	250	250	250	250
Reverse protection	•	•	•	•
Voltage drop max. [V]	1.5	1.5	1.5	1.5
Residual current [mA]	-	-	-	-
Current consumption (not actuated) [mA]	1	1	1	1
Switching frequency [Hz]	500	200	500	200
Ambient temperature [°C]	-25...+70	-25...+70	-25...+70	-25...+70
EMC-class	A	A	A	A
Protection [EN 60529]	IP 67	IP 67	IP 67	IP 67
LED display	•	•	•	•
Housing material	Br-Ni / PPO	Br-Ni / PPO	Br-Ni / PPO	Br-Ni / PPO
Connection	2 m PVC-cable 3x0.5 mm <sup>2</sup>	2 m PVC-cable 3x0.5 mm <sup>2</sup>	M12 connector	M12 connector
Accessories				

connecting cable SLG 3-2, page 3.69





# Standard switches

## Proximity switches

### Smooth-bodied switch

Ø 20 mm / Ø 34 mm

DC 10...55 V

Sensors for AC voltage are available on request



Design	DC PNP		DC PNP	
	Ø 20 mm	Ø 34 mm	Ø 20 mm	Ø 34 mm
			programmable	
<b>Dimensions</b>				
Installation non flush (nf)				
Operating distance sn [mm]	10 nf	20 nf	10 nf	20 nf
Switching output PNP				
ID-No.	P30159	P30166	P30158	P30165
Type	INK 010 GSP	INK 020 GSP	INKS 010 GPP	INKS 020 GPP
Supply voltage [V]	10...55 DC	10...55 DC	10...55 DC	10...55 DC
Switching current [mA]	400	400	400	400
Short circuit proof	•	•	•	•
Overcurrent release [mA]	450	450	450	450
Reverse protection	•	•	•	•
Voltage drop max. [V]	2	2	2	2
Residual current [mA]	-	-	-	-
Current consumption (not actuated) [mA]	2.5	2.5	2.5	2.5
Switching frequency [Hz]	1500	500	1500	500
Ambient temperature [°C]	-25...+75	-25...+75	-25...+75	-25...+75
EMC-class	A	A	A	A
Protection [EN 60529]	IP 67	IP 67	IP 67	IP 67
LED display	•	•	•	•
Housing material	PBT	PBT	PBT	PBT
Connection	2 m PVC-cable 3x0.5 mm <sup>2</sup>	2 m PVC-cable 3x0.5 mm <sup>2</sup>	2 m PVC-cable 3x0.5 mm <sup>2</sup> (PG-plug connection)	2 m PVC-cable 3x0.5 mm <sup>2</sup> (PG-plug connection)
PG-plug connection				
DC 1: BN 2: BU 3: BK				
Schalter / switch Disconnect power supply before pulling off plug connector. Spannungsversorgung abschalten bevor Steckverbindung gezogen wird.				
Accessories	mounting clamps Ø 20 mm (Z00100), Ø 34 mm (Z00102) are part of delivery			



Special functions | Surface sensor

Proximity switches

Wide detection range

DC 10...55 V

Sensitivity adjustable  
Moisture-resistant  
PG-plug IP 68



Design	DC PNP				
Dimensions					
Installation	non flush (nf)				
Operating distance sn [mm]	100 nf	100 nf	130 nf	150 nf	180 nf
Adjustable range max.	120	150	170	200	250
Switching output PNP					
ID-No.	<b>P31016</b>	<b>P31018</b>	<b>P31020</b>	<b>P31022</b>	<b>P31024</b>
Type	IFE 200/100 GSP	IFE 400/100 GSP	IFE 400/150 GSP	IFE 700/150 GSP	IFE 900/150 GSP
Dimensions	L	200	400	400	700
	B	100	100	150	150
	Si	108	280	230	190
Supply voltage [V]	10...55 DC				
Switching current [mA]	< 400				
Short circuit protection	•				
Overcurrent release approx. [mA]	430				
Reverse protection	•				
Current consumption approx. [mA]	4				
Inverse current max. [µA]	1				
Residual ripple max. [%]	15				
Voltage drop max. [V]	2				
Switching frequency [Hz]	10				
Hysteresis [%]	10				
Ambient temperature [°C]	-25...+75				
Correction factors	St 37: 1	AL: 0.4	VA 4: 0.65	Cu: 0.45	ZN: 0.5 MS: 0.6
EMC-class	A				
Protection [EN 60529]	IP 68				
Housing material	PVC / Aluminium				
Connection	PG-plug connection, 2 m PVC-cable 3x0.5 mm <sup>2</sup>				
Notes	see page 3.3				



## Special functions | Offshore

## Proximity switches

M12 / M18  
Stainless steel sleeve

DC 10...30 V

High compressive strength  
Longitudinal water blocked cable  
Sea water proofed



Design	DC PNP • M12x1	DC PNP • M18x1
Dimensions		
Installation flush (f)		
Operating distance $s_n$ [mm]	2 f	5 f
Switching output PNP		
ID-No.	P31223	P31224
Type	IGMO 02 GSP	IGMO 05 GSP
Supply voltage [V]	10...30 DC	
Switching current [mA]	200	
Short circuit proof	•	
Reverse protection	•	
Current consumption [mA]	4	
Switching frequency [Hz]	200	
Ambient temperature [°C]	-25...+70	
Compressive strength [bar]	30	
Protection [EN 60529]	IP 68	
Housing material	PTFE / AISI 316 Ti	
Sealing material	FKM	
Connection	1 m longitudinal water blocked cable	



Special functions | Offshore

Proximity switches

M18 / M30  
One piece stainless steel housing

DC 10...30 V

High compressive strength  
Longitudinal water blocked cable  
Sea water proofe



Design	DC PNP • M18x1	DC PNP • M30x1.5
Dimensions		
Installation flush (f)		
Operating distance sn [mm]	5 b	10 b
Switching output PNP		
ID-No.	<b>P31365</b>	<b>P31366</b>
Type	IGVO 05 GSP	IGVO 10 GSP
Supply voltage [V]	10...30 DC	
Switching current [mA]	250	
Short circuit proof	•	
Reverse protection	•	
Current consumption max.[mA]	5	
Switching frequency [Hz]	180	150
Ambient temperature [°C]	-25...+70	
Compressive strength [bar]	30	
Protection [EN 60529]	IP 68 + IP 69	
EMC-class	A	
Housing material	AISI 316 L	
Sealing material	FKM	
Connection	1 m longitudinal water blocked cable PLWDC-cable 3x0.5 mm <sup>2</sup>	



Special functions | Washing resistant

Proximity switches

DC 10...30 V

110 °C Permanent temperature  
Resistant to hot steam  
Resistant to detergents

IP 68 + IP 69



Design	DC PNP • Ø 80 mm	DC PNP • Ø 120 mm
Dimensions		
Installation non flush (nf)		
Operating distance sn [mm]	55 nf	90 nf
Switching output PNP		
ID-No.	P31214	P31177
Type	IDKW 080 GSP	IDKW 120 GSP
Supply voltage [V]	10...30 DC	
Switching current [mA]	300	
Hysteresis	< 0.1 Sn	
Voltage drop max. [V]	2	
Current consumption [mA]	10	
Switching frequency [Hz]	30	
Ambient temperature [°C]	-20...+110	
Limiting temperature [°C]	120	
Temperature deviation [%]	≤ 10	
EMC-class	A	
Protection [EN 60529]	IP 68 + IP 69	
Housing material	PP / AISI 316 Ti	
Sealing material	EPDM	
Connection	5 m FEP-cable 3x0.75 mm <sup>2</sup> , shielded	
Switching current		



# Special functions | Factor 1

## Proximity switches

M30  
 Ø 80 mm / Ø 160 mm

DC 10...30 V

Correction factor 1  
 for all metals



Design	M30x1.5	M30x1.5	Ø 80 mm	Ø 160 mm
<b>Dimensions</b>				
Installation flush (f) non flush (nf) adjustable (a)				
Operating distance sn [mm]	10 f	20 nf	70 nf-a	150 nf-a
Switching output PNP				
ID-No.	P31135	P31136	P31141	P31142
Type	IGBS 010 GSP	IGBS 020 GSP	IDBS 080 GPP	IDBS 160 GPP
Supply voltage [V]	10...30 DC			
Switching current [mA]	200			
Short circuit proof	•			
Current consumption [mA]	25			
Reverse protection	•			
Voltage drop max. [V]	2			
Switching frequency [Hz]	300		20	
Ambient temperature [°C]	-25...+75			
EMC-class	A			
Protection [EN 60529]	IP 67			
Housing material	Br-Ni / PBT		PBT / Aluminium	
Connection	M12 connector		PG-plug connection 2 m, 3x0.5 mm <sup>2</sup> PVC	
PG-plug-system				
<p>AC DC</p> <p>1: BN 1: BN</p> <p>2: BU 2: BU</p> <p>3: BK 3: BK</p> <p>Schalter / switch</p> <p>Disconnect power supply before pulling off plug connector. Spannungsversorgung abschalten bevor Steckverbindung gezogen wird.</p> <p>NO NC</p>				



# Metal face sensor | Speed sensor | $-40...+150\text{ }^{\circ}\text{C}$

Proximity switches

Detection of ferromagnetic targets

One piece stainless steel housing

$-40...+150\text{ }^{\circ}\text{C}$

IP 68 Water-proofed

IP 69 Resistant to high pressure cleaning



Design	DC PNP • M18x1
<i>Dimensions</i>	
Operating distance sn [mm]	3
Switching output PNP	
ID-No.	P31364
Type	HGVB 03 GSP
Supply voltage [V]	10...30 DC
Switching current max. [mA]	100
Short circuit proof	•
Reverse protection	•
Voltage drop max. [V]	2.5
Current consumption max. [mA]	20
Switching frequency [Hz]	6000
Ambient temperature [°C]	$-40...+150$
EMC-class	A
Protection [EN 60529]	IP 68 + IP 69
Housing material	AISI 316 L
Connection	2 m FEP-cable 3x0.34 mm <sup>2</sup>







**Sensors**  
**Compact models**  
**Amplifiers**





Dust / Gas- | Compact model | Zone 0/20

Proximity switches

Gas-Ex Category 1  
Ex ma IIC T6 Ga

Dust-Ex Category 1  
Ex ma IIIC T90°C Da



Design	DC PNP • M12x1		DC PNP • M18x1		DC PNP • M30x1.5	
Dimensions						
Installation flush (f) non flush (nf)	LED		LED		LED	
Operating distance [mm]	2 f		5 f		10 f	
Switching output PNP	4 nf		8 nf		15 nf	
ID-No.	P31379		P31381		P31383	
Type	IGEX20a 02 GSP		IGEX20a 05 GSP		IGEX20a 10 GSP	
Ex area of use	Gas: Zone 0/1 / Dust: Zone 20/21					
Certificate No.	EPS 17 ATEX 1 117 X			IECEX EPS 17.0059X		
Ex marking	Gas:  II 1G Ex ma IIC T6 Ga			Ex ma IIC T6 Ga		
	Dust:  II 1D Ex ma IIIC T90°C Da			Ex ma IIIC T90°C Da		
Ambient temperature [°C]	Gas Zone 0: T6: -20 ≤ Ta ≤ +60 * T5: -20 ≤ Ta ≤ +60 * T4: -20 ≤ Ta ≤ +60 * T3: -20 ≤ Ta ≤ +60 *		Gas Zone 1: T6: -20 ≤ Ta ≤ +60 * T5: -20 ≤ Ta ≤ +60 * T4: -20 ≤ Ta ≤ +60 * T3: -20 ≤ Ta ≤ +60 *		Dust Zone 20: -20 ≤ Ta ≤ +60 *	
* +55 for type M12x1					Dust Zone 21: -20 ≤ Ta ≤ +60 *	
Supply voltage [V]	24 DC ±10%					
Switching current [mA]	50					
Rated voltage [V]	27 DC					
Rated current [mA]	50					
LED display	red	red	yellow	yellow	yellow	yellow
Impact protection cap		•		•		•
Housing material	AISI 316 Ti / PPSU / LCP / POM			Br-Ni / PA / POM		
Protection [EN 60529]	IP 67					
Connection	2 m PUR-cable 3x0.34 mm <sup>2</sup>					
Note	<div style="display: flex; align-items: center; justify-content: space-between;"> <div style="text-align: center;"> <p>explosionsgefährdeter Bereich (Gas oder Staub) <i>hazardous area (gas or dust)</i></p> </div> <div style="text-align: center;"> </div> <div style="text-align: center;"> <p>nicht explosionsgefährdeter Bereich <i>non hazardous area</i></p> </div> </div>					



Dust / Gas-Ex | Compact model | Zone 0/20

Proximity switches

Gas-Ex Category 1  
Ex ma IIC T6 Ga

Dust-Ex Category 1  
Ex ma IIIC T90°C Da

Ambient temperature up to -60 °C



Design	DC PNP • M12x1		DC PNP • M18x1		DC PNP • M30x1.5	
Dimensions						
Installation flush (f) non flush (nf)	LED	LED	LED	LED	LED	LED
Operating distance [mm]	2 f	4 nf	5 f	8 nf	10 f	15 nf
Switching output PNP						
ID-No.	P31385	P31386	P31387	P31388	P31389	P31390
Type	IGEX20Pa 02 GSP	IGEX20Pa 04 GSP	IGEX20Pa 05 GSP	IGEX20Pa 08 GSP	IGEX20Pa 10 GSP	IGEX20Pa 15 GSP
Ex area of use	Gas: Zone 0/1 / Staub: Zone 20/21					
Certificate No.	EPS 17 ATEX 1 117 X			IECEx EPS 17.0059X		
Ex marking	Gas:  II 1G Ex ma IIC T6 Ga Dust:  II 1D Ex ma IIIC T90°C Da			Ex ma IIC T6 Ga Ex ma IIIC T90°C Da		
Ambient temperature [°C]	Gas Zone 0: T6: -20 ≤ Ta ≤ +60 * T5: -20 ≤ Ta ≤ +60 * T4: -20 ≤ Ta ≤ +60 * T3: -20 ≤ Ta ≤ +60 *		Gas Zone 1: T6: -60 ≤ Ta ≤ +60 * T5: -60 ≤ Ta ≤ +60 * T4: -60 ≤ Ta ≤ +60 * T3: -60 ≤ Ta ≤ +60 *		Dust Zone 20: -20 ≤ Ta ≤ +60 *	
* +55 for type M12x1					Dust Zone 21: -60 ≤ Ta ≤ +60 *	
Supply voltage [V]	24 DC ±10%					
Switching current [mA]	50					
Rated voltage [V]	27 DC					
Rated current [mA]	50					
LED display	yellow	yellow	yellow	yellow	yellow	yellow
Impact protection cap		•		•		•
Housing material	AISI 316 Ti / PTFE / PVDF / POM					
Protection [EN 60529]	IP 68 (3 bar)					
Connection	2 m FEP-cable 3x0.34 mm <sup>2</sup>					
Note	<div style="display: flex; justify-content: space-between;"> <div style="text-align: center;"> <p>explosionsgefährdeter Bereich (Gas oder Staub) hazardous area (gas or dust)</p> </div> <div style="text-align: center;"> </div> <div style="text-align: center;"> <p>nicht explosionsgefährdeter Bereich non hazardous area</p> </div> </div>					



Dust / Gas- | Intrinsically safe | Zone 0/20

Proximity switches

Gas-Ex Category 1  
Ex ia IIC T6 Ga

Dust-Ex Category 1  
Ex ia IIIC T80°C Da



Design	M12x1		M18x1		M30x1.5	
Dimensions						
Installation flush (f) non flush (nf)						
Operating distance [mm]	2 f	4 nf	5 f	8 nf	10 f	15 nf
ID-No.	P31412	P31413	P31414	P31415	P31416	P31417
Type	IGEXUa 02	IGEXUa 04	IGEXUa 05	IGEXUa 08	IGEXUa 10	IGEXUa 15
Ex area of use	Gas: Zone 0/1 / Dust: Zone 20/21					
Certification No.	EPS 17 ATEX 1 173 X			IECEx EPS 17.0087X		
Ex marking	Gas:  II 1G Ex ia IIC T6 Ga Dust:  II 1D Ex ia IIIC T80°C Da			Gas: Ex ia IIC T6 Ga Dust: Ex ia IIIC T80°C Da		
Ambient temperature [°C] and medium temperature	Gas Zone 0: T6: -20 ≤ Ta ≤ +60 T5: -20 ≤ Ta ≤ +60 T4: -20 ≤ Ta ≤ +60 T3: -20 ≤ Ta ≤ +60		Gas Zone 1: T6: -25 ≤ Ta ≤ +75 T5: -25 ≤ Ta ≤ +75 T4: -25 ≤ Ta ≤ +75 T3: -25 ≤ Ta ≤ +75		Dust Zone 20: -25 ≤ Ta ≤ +75	
Maximum values	Ui = 12.6 V / li = 15.9 mA / Pi = 50 mW / Ci = 66.2 nF / Li = 1.2 mH					
Housing material	Br-Ni / PA					
Protection [EN 60529]	IP 67					
Connection	M12 connector					
For the connection to amplifiers IKMb 122 Ex..., page 3.67						



Dust / Gas- | Intrinsically safe | Zone 0/20

Proximity switches

Gas-Ex Category 1  
Ex ia IIC T6 Ga

Dust-Ex Category 1  
Ex ia IIIC T80°C Da



Design	M12x1		M18x1		M30x1.5	
<b>Dimensions</b>						
Installation flush (f) non flush (nf)						
Operating distance [mm]	2 f	4 nf	5 f	8 nf	10 f	15 nf
ID-No.	P31445	P31446	P31447	P31448	P31449	P31450
Type	IGEXa 02	IGEXa 04	IGEXa 05	IGEXa 08	IGEXa 10	IGEXa 15
Ex area of use	Gas: Zone 0/1 / Dust: Zone 20/21					
Certification No.	EPS 17 ATEX 1 173 X			IECEx EPS 17.0087X		
Ex marking	Gas:  II 1G Ex ia IIC T6 Ga Dust:  II 1D Ex ia IIIC T80°C Da			Gas: Ex ia IIC T6 Ga Dust: Ex ia IIIC T80°C Da		
Ambient temperature [°C] and medium temperature	Gas Zone 0: T6: -20 ≤ Ta ≤ +60 T5: -20 ≤ Ta ≤ +60 T4: -20 ≤ Ta ≤ +60 T3: -20 ≤ Ta ≤ +60		Gas Zone 1: T6: -25 ≤ Ta ≤ +75 T5: -25 ≤ Ta ≤ +75 T4: -25 ≤ Ta ≤ +75 T3: -25 ≤ Ta ≤ +75		Dust Zone 20: -25 ≤ Ta ≤ +75	
Maximum values	Ui = 12.6 V / li = 15.9 mA / Pi = 50 mW / Ci = 66.2 nF / Li = 1.2 mH					
Housing material	Br-Ni / PA					
Protection [EN 60529]	IP 67					
Connection	2 m PVC-cable 2x0.5 m <sup>2</sup>					
For the connection to amplifiers IKMb 122 Ex..., page 3.67	<p>explosionsgefährdeter Bereich hazardous area   nicht explosionsgefährdeter Bereich non hazardous area</p> <p>BN (+) BU (-)   IKMb 122 Ex-...   Betriebsspannung / Supply voltage, Relais Ausgang / Relay output</p>					
Note	proximity switches with cable length > 2 m are available on request					



Dust / Gas-**Ex** | Intrinsically safe | Zone 0/20

Proximity switches

Gas-Ex Category 1  
Ex ia IIC T6 Ga

Dust-Ex Category 1  
Ex ia IIIC T145°C Da

High temperature sensors +140 °C  
IP 69 Resistant to high pressure cleaning



Design	M12x1		M18x1		M30x1.5	
Dimensions						
Installation flush (f) non flush (nf)	flush (f) non flush (nf)		flush (f) non flush (nf)		flush (f) non flush (nf)	
Operating distance [mm]	2 f	4 nf	5 f	8 nf	10 f	15 nf
ID-No.	P31400	P31401	P31402	P31403	P31404	P31405
Type	IGEXHa 02	IGEXHa 04	IGEXHa 05	IGEXHa 08	IGEXHa 10	IGEXHa 15
Ex area of use	Gas: Zone 0/1 / Dust: Zone 20/21					
Certificate No.	EPS 17 ATEX 1 173 X			IECEx EPS 17.0087X		
Ex marking	Gas: <b>Ex</b> II 1G Ex ia IIC T6 Ga Dust: <b>Ex</b> II 1D Ex ia IIIC T145°C Da			Gas: Ex ia IIC T6 Ga Dust: Ex ia IIIC T145°C Da		
Ambient temperature [°C] and medium temperature	Gas Zone 0: T6: -20 ≤ Ta ≤ +60 T5: -20 ≤ Ta ≤ +60 T4: -20 ≤ Ta ≤ +60 T3: -20 ≤ Ta ≤ +60		Gas Zone 1: T6: -25 ≤ Ta ≤ +75 T5: -25 ≤ Ta ≤ +90 T4: -25 ≤ Ta ≤ +125 T3: -25 ≤ Ta ≤ +140		Dust Zone 20: -25 ≤ Ta ≤ +140	
Maxium values	Ui = 12.6 V / li = 15.9 mA / Pi = 50 mW / Ci = 66.2 nF / Li = 1.2 mH					
Housing material	AISI 316 Ti / PEEK					
Protection [EN 60529]	IP 68 (3 bar), IP 69					
Connection	2 m FEP-cable 2x0.34 mm <sup>2</sup>					
Sensors for the connection to amplifiers IKMb 122 Ex..., page 3.67						
Note	proximity switches with cable length > 2 m are available on request					



Dust / Gas- $\text{Ex}$  | Intrinsically safe | Zone 0/20

Proximity switches

Gas-Ex Category 1  
Ex ia IIC T6 Ga

Dust-Ex Category 1  
Ex ia IIIC T65°C Da

POLAR-Sensors -60 °C  
IP 69 Resistant to high pressure cleaning



Design	M12x1		M18x1		M30x1.5	
Dimensions						
Installation flush (f) non flush (nf)						
Operating distance [mm]	2 f	4 nf	5 f	8 nf	10 f	15 nf
ID-No.	P31406	P31407	P31408	P31409	P31410	P31411
Type	IGEXPa 02	IGEXPa 04	IGEXPa 05	IGEXPa 08	IGEXPa 10	IGEXPa 15
Ex area of use	Gas: Zone 0/1 / Dust: Zone 20/21					
Certificate No.	EPS 17 ATEX 1 173 X			IECEx EPS 17.0087X		
Ex marking	Gas: $\text{Ex}$ II 1G Ex ia IIC T6 Ga Dust: $\text{Ex}$ II 1D Ex ia IIIC T65°C Da			Gas: Ex ia IIC T6 Ga Dust: Ex ia IIIC T65°C Da		
Ambient temperature [°C] and medium temperature	Gas Zone 0: T6: $-20 \leq T_a \leq +60$ T5: $-20 \leq T_a \leq +60$ T4: $-20 \leq T_a \leq +60$ T3: $-20 \leq T_a \leq +60$		Gas Zone 1: T6: $-60 \leq T_a \leq +60$ T5: $-60 \leq T_a \leq +60$ T4: $-60 \leq T_a \leq +60$ T3: $-60 \leq T_a \leq +60$		Dust Zone 20: $-60 \leq T_a \leq +60$	
Maxium values	Ui = 12.6 V / li = 15.9 mA / Pi = 50 mW / Ci = 66.2 nF / Li = 1.2 mH					
Housing material	AISI 316 Ti / PTFE / PVDF					
Protection [EN 60529]	IP 68 (3 bar), IP 69					
Connection	2 m FEP-cable 2x0.34 mm <sup>2</sup>					
Sensors for the connection to amplifiers IKMb 122 Ex..., page 3.67						
Note	proximity switches with cable length > 2 m are available on request					



Dust / Gas- | Compact model | Zone 2/22

Proximity switches

Gas-Ex Category 3  
Ex ec IIC T6...T3 Gc

Dust-Ex Category 3  
Ex tc IIIC T70°C Dc



Design	DC PNP • M12x1		DC PNP • M18x1		DC PNP • M30x1.5	
Dimensions						
Installation flush (f) non flush (nf)						
Operating distance [mm]	2 f	4 nf	5 f	8 nf	10 f	15 nf
Switching output PNP						
ID-No.	P31391	P31392	P31393	P31394	P31395	P31396
Type	IGEX22c 02 GSP	IGEX22c 04 GSP	IGEX22c 05 GSP	IGEX22c 08 GSP	IGEX22c 10 GSP	IGEX22c 15 GSP
Ex area of use	Gas: Zone 2 / Dust: Zone 22					
Certificate No.	IECEx EPS 17.0042X					
Conformity No.	EGE 18.0020 X					
Ex marking	Gas:  II 3G Ex ec IIC T6...T3 Gc Dust:  II 3D Ex tc IIIC T70°C Dc		Gas: Ex ec IIC T6...T3 Gc Dust: Ex tc IIIC T70°C Dc			
Ambient temperature [°C] and medium temperature	Gas Zone 2:		T6: -20 ≤ Ta ≤ +60 T5: -20 ≤ Ta ≤ +60 T4: -20 ≤ Ta ≤ +60 T3: -20 ≤ Ta ≤ +60			
	Dust Zone 22:		-20 ≤ Ta ≤ +60			
Rated voltage [V]	30 DC					
Supply voltage [V]	24 DC ±10%					
Switching current [mA]	100					
Switching frequency [Hz]	300					
LED display	red	red	yellow	yellow	yellow	yellow
Impact protection cap		•		•		•
Housing material	AISI 316 Ti / PPSU / LCP / POM		Br-Ni / PA / POM			
Protection [EN 60529]	IP 67					
Connection	2 m PUR-cable 3x0.34 mm <sup>2</sup>					
Note	proximity switches with cable length > 2 m are available on request					





Dust / Gas- | Compact model | Zone 2/22

Proximity switches

Gas-Ex Category 3  
Ex ec IIC T6...T3 Gc

Dust-Ex Category 3  
Ex tc IIIC T 70°C Dc

One piece stainless steel housing



Design	DC PNP • M12x1	DC PNP • M18x1	DC PNP • M30x1.5
Dimensions			
Operating distance [mm]	2	5	10
Switching output PNP			
ID-No.	P31397	P31398	P31399
Type	IGVEX22c 02 GSP	IGVEX22c 05 GSP	IGVEX22c 10 GSP
Ex area of use	Gas: Zone 2 / Dust: Zone 22		
Certificate No.	IECEx EPS 17.0042X		
Conformity No.	EGE 18.0020 X		
Ex marking	Gas:  II 3G Ex ec IIC T6...T3 Gc Dust:  II 3D Ex tc IIIC T 70°C Dc	Gas: Ex ec IIC T6...T3 Gc Dust: Ex tc IIIC T 70°C Dc	
Ambient temperature and medium temperature [°C]	Gas Zone 2: T6: -5 ≤ Ta ≤ +55 T5: -5 ≤ Ta ≤ +55 T4: -5 ≤ Ta ≤ +55 T3: -5 ≤ Ta ≤ +55 Dust Zone 22: -5 ≤ Ta ≤ +55	Gas Zone 2: T6: -10 ≤ Ta ≤ +55 T5: -10 ≤ Ta ≤ +55 T4: -10 ≤ Ta ≤ +55 T3: -10 ≤ Ta ≤ +55 Dust Zone 22: -10 ≤ Ta ≤ +55	Gas Zone 2: T6: -20 ≤ Ta ≤ +60 T5: -20 ≤ Ta ≤ +60 T4: -20 ≤ Ta ≤ +60 T3: -20 ≤ Ta ≤ +60 Dust Zone: -20 ≤ Ta ≤ +60
Rated voltage [V]	30 DC		
Supply voltage [V]	24 DC ±10%		
Switching current [mA]	100		
Switching frequency [Hz]	180		
LED display	red	yellow	yellow
Housing material	AISI 316 L / PPSU	AISI 316 L / PA	AISI 316 L / PA
Protection [EN 60529]	IP 67		
Connection	2 m PUR-cable 3x0.34 mm <sup>2</sup>		
Note	proximity switches with cable length > 2 m are available on request		



Dust / Gas-Ex | Compact model | Zone 2/22

Proximity switches

Gas-Ex Category 3  
Ex ec IIC T6...T3 Gc

Dust-Ex Category 3  
Ex tc IIIC T70°C Dc

One piece stainless steel housing  
Silicone cable



Design	DC PNP • M12x1	DC PNP • M18x1	DC PNP • M30x1.5
Dimensions			
Operating distance [mm]	2	5	10
Switching output PNP			
ID-No.	P31421	P31422	P31423
Type	IGVEX22c 02 GSP-K1	IGVEX22c 05 GSP-K1	IGVEX22c 10 GSP-K1
Ex area of use	Gas: Zone 2 / Dust: Zone 22		
Certificate No.	IECEx EPS 17.0042X		
Conformity No.	EGE 18.0020 X		
Ex marking	Gas:  II 3G Ex ec IIC T6...T3 Gc Dust:  II 3D Ex tc IIIC T70°C Dc	Gas: Ex ec IIC T6...T3 Gc Dust: Ex tc IIIC T70°C Dc	
Ambient temperature and medium temperature [°C]	Gas Zone 2: T6: -20 ≤ Ta ≤ +55 T5: -20 ≤ Ta ≤ +55 T4: -20 ≤ Ta ≤ +55 T3: -20 ≤ Ta ≤ +55 Dust Zone 22: -20 ≤ Ta ≤ +55		Gas Zone 2: T6: -20 ≤ Ta ≤ +60 T5: -20 ≤ Ta ≤ +60 T4: -20 ≤ Ta ≤ +60 T3: -20 ≤ Ta ≤ +60 Dust Zone: -20 ≤ Ta ≤ +60
Rated voltage [V]	30 DC		
Supply voltage [V]	24 DC ±10%		
Switching current [mA]	100		
Switching frequency [Hz]	180		
LED display	red	yellow	yellow
Housing material	AISI 316 L / PPSU	AISI 316 L / PA	AISI 316 L / PA
Protection [EN 60529]	IP 67		
Connection	2 m silicone-cable 3x0.34 mm <sup>2</sup>		
Note	proximity switches with cable length > 2 m are available on request		



**Ex-Amplifiers**

Gas [Ex ia Ga] IIC  
Dust [Ex ia Da] IIIC

Cable break and  
short circuit monitoring

Connection to intrinsically safe  
2-lead sensors

Output function programmable



**Design** IKMb 122 Ex...

*Dimensions*

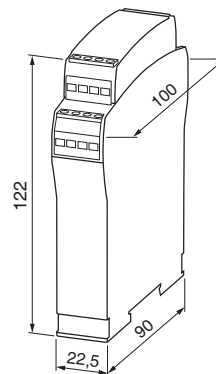

<b>ID-No.</b>	<b>P31418</b>	<b>P31420</b>	<b>P31419</b>
Type	IKMb 122 Ex-24	IKMb 122 Ex-115	IKMb 122 Ex-230
Output	 relay / change over		
Ex area of use	outside of the hazardous areas (gas or dust)		
Certificate No.	EPS 17 ATEX 1 091		IECEX EPS 17.0047
Ex marking	Gas:  [Ex ia Ga] IIC Dust:  [Ex ia Da] IIIC	Gas: [Ex ia Ga] IIC Dust: [Ex ia Da] IIIC	
Ambient temperature [°C]	-20 ≤ Ta ≤ +60		
Maximum values	Uo = 9.6 V / Io = 10.1 mA / Po = 24.2 mW / Co = 0.84 µF / Lo = 5.00 mH		
Rated voltage [V]	30 DC	127 AC	253 AC
Supply voltage [V]	24 DC ±10%	115 AC ±10%	230 AC ±10%
Switching voltage max. [V]	250 AC / 60 DC / 24 DC		
Switching current max. [A]	4 AC / 0,8 DC / 4 DC		
Switching power	cos φ >0,7 / L/R ≤ 200 ms / L/R ≤ 200 ms		
LED display	power: green / switching output: yellow / cable break: red		
Protection [EN 60529]	IP 20		
Connection	terminal screws		

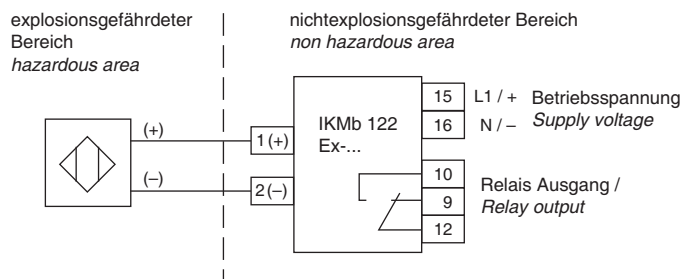



**Ex-Amplifiers**

Gas [Ex ia Ga] IIC  
Dust [Ex ia Da] IIIC

Cable break and  
short circuit monitoring

Connection to intrinsically safe  
3-lead sensors

Output function programmable



**Design** **IKMb 123 Ex...**

**Dimensions**

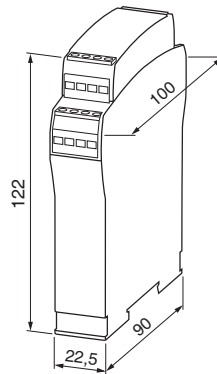

<b>ID-No.</b>	<b>P31451</b>	<b>P31453</b>	<b>P31452</b>
<b>Type</b>	IKMb 123 Ex-24	IKMb 123 Ex-115	IKMb 123 Ex-230
<b>Output</b>	 relay / change over		
<b>Ex area of use</b>	outside of the hazardous areas (gas or dust)		
<b>Certificate No.</b>	EPS 17 ATEX 1 091		IECEX EPS 17.0047
<b>Ex marking</b>	Gas:  II (1)G [Ex ia Ga] IIC Dust:  II (1)D [Ex ia Da] IIIC	Gas: [Ex ia Ga] IIC Dust: [Ex ia Da] IIIC	
<b>Ambient temperature</b> [°C]	-20 ≤ Ta ≤ +60		
<b>Maximum values</b>	Uo = 9.6 V / Io = 50.5 mA / Po = 121.3 mW / Co = 0.68 µF / Lo = 5.00 mH		
<b>Rated voltage</b> [V]	30 DC	127 AC	253 AC
<b>Supply voltage</b> [V]	24 DC ±10%	115 AC ±10%	230 AC ±10%
<b>Switching voltage max.</b> [V]	250 AC / 60 DC / 24 DC		
<b>Switching current max.</b> [A]	4 AC / 0,8 DC / 4 DC		
<b>Switching power</b>	cos φ >0,7 / L/R ≤ 200 ms / L/R ≤ 200 ms		
<b>LED display</b>	power: green / switching output: yellow / cable break: red		
<b>Protection</b> [EN 60529]	IP 20		
<b>Connection</b>	terminal screws		

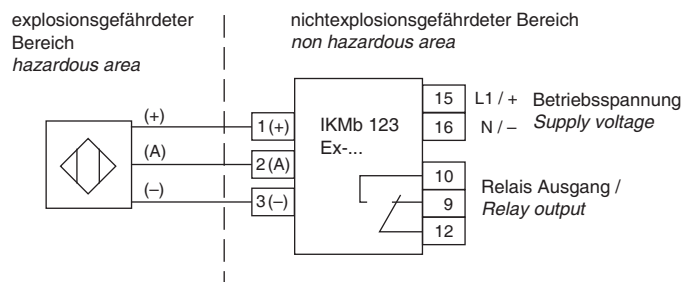



## Accessories | M12 connector

Finished cable plug housing  
Self locking screw plug  
Protection IP 67

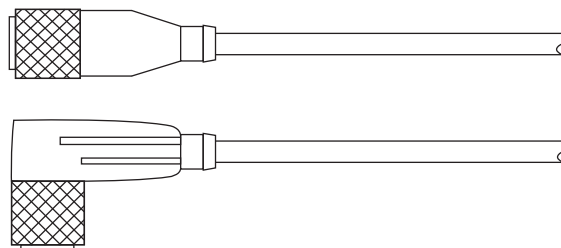

### Cable plug housing

straight

angular

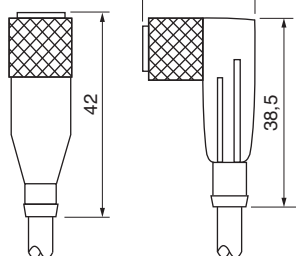

SLG...

SLW...

### Pin-assignment

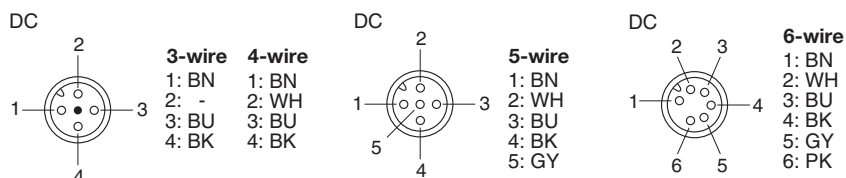

DC

TYPE	ID-NO.	DESIGN
SLG 3-2	Z01076	Cable plug housing straight, 2 m cable 3x0.34 mm <sup>2</sup> max. 250 V / 4 A
SLG 3-5	Z01077	Cable plug housing straight, 5 m cable 3x0.34 mm <sup>2</sup> max. 250 V / 4 A
SLW 3-2	Z01078	Cable plug housing angular, 2 m cable 3x0.34 mm <sup>2</sup> max. 250 V / 4 A
SLW 3-5	Z01079	Cable plug housing angular, 5 m cable 3x0.34 mm <sup>2</sup> max. 250 V / 4 A
SLW 3-2-LED	Z00052	Cable plug housing angular, 2 m cable 3x0.34 mm <sup>2</sup> max. 250 V / 4 A PNP with LED
SLG 4-2	Z00445	Cable plug housing straight, 2 m cable 4x0.25 mm <sup>2</sup> max. 250 V / 4 A
SLG 4-5	Z00449	Cable plug housing straight, 5 m cable 4x0.25 mm <sup>2</sup> max. 250 V / 4 A
SLW 4-2	Z00446	Cable plug housing angular, 2 m cable 4x0.25 mm <sup>2</sup> max. 250 V / 4 A
SLW 4-5	Z00450	Cable plug housing angular, 5 m cable 4x0.25 mm <sup>2</sup> max. 250 V / 4 A
SLW 4-2-LED	Z01157	Cable plug housing angular, 2 m cable 4x0.25 mm <sup>2</sup> max. 250 V / 4 A PNP with LED
SLG 5-2	Z01150	Cable plug housing straight, 2 m cable 5x0.34 mm <sup>2</sup> max. 60 V / 2 A
SLW 5-2	Z01151	Cable plug housing angular, 2 m cable 5x0.34 mm <sup>2</sup> max. 60 V / 2 A
SLG 6-2	Z01197	Cable plug housing straight, 2 m cable 6x0.25 mm <sup>2</sup> max. 36 V / 2 A
SLW 6-2	Z01198	Cable plug housing angular, 2 m cable 6x0.25 mm <sup>2</sup> max. 36 V / 2 A

### DATA

Thread	M12x1	Contact resistance	≤ 5 mΩ
Material	PVC	Insulation resistance	>10 <sup>9</sup>
Protection	IP 67	Testing voltage	2.0 KV eff. / 5 and 6 pol. 1.5 KV eff.
Temperature range	-25...+80 °C		

### Note:

Sensors with NC output are connected to 4 pole cable plug housings. In this case, the break output is connected to the white lead (connection 2).



# Accessories | PG plug system

## PG plug type connection with PVC-cable Protection IP 68

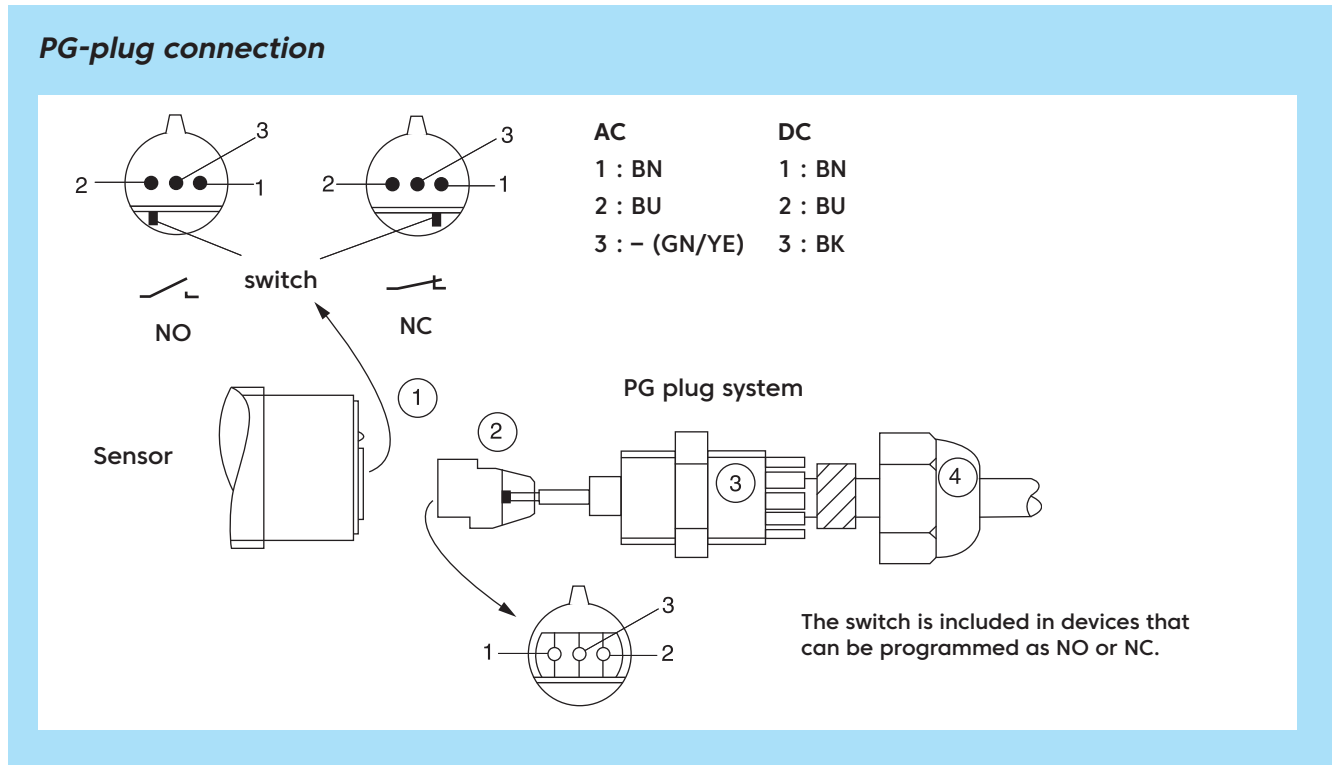

### Mounting of PG plug system

Connect the cable to the EGE-plug (2) and put it into the plug-housing (1) until it is at the stop. Make sure that the "nose" of the plug fits exactly into the housing. If this is done in the right way, the plug is hidden in the plug-housing.

Screw part (3) into the plug-housing (1) and fix it rightly with a spanner. After about 2 hours tighten it again with the spanner.

Now fit the nut (4) by hand and afterwards with a spanner. Do not apply too much force. For a good sealing there should be stet 2 mm between nut (4) and part (3).

TYPE	ID-NO.	DESIGN
PG 2-2	Z00025	PG-plug connection, 2 m PVC-cable 2x0.75 mm <sup>2</sup> AC
PG 2-3	Z00026	PG-plug connection, 3 m PVC-cable 2x0.75 mm <sup>2</sup> AC
PG 2-5	Z00027	PG-plug connection, 5 m PVC-cable 2x0.75 mm <sup>2</sup> AC
PG 2-10	Z00028	PG-plug connection, 10 m PVC-cable 2x0.75 mm <sup>2</sup> AC
PG 2-20	Z00029	PG-plug connection, 20 m PVC-cable 2x0.75 mm <sup>2</sup> AC
PG 3-2	Z00020	PG-plug connection, 2 m PVC-cable 3x0.5 mm <sup>2</sup> DC
PG 3-3	Z00021	PG-plug connection, 3 m PVC-cable 3x0.5 mm <sup>2</sup> DC
PG 3-5	Z00022	PG-plug connection, 5 m PVC-cable 3x0.5 mm <sup>2</sup> DC
PG 3-10	Z00023	PG-plug connection, 10 m PVC-cable 3x0.5 mm <sup>2</sup> DC
PG 3-20	Z00024	PG-plug connection, 20 m PVC-cable 3x0.5 mm <sup>2</sup> DC

### Note

The power supply must be disconnected before the plug will be installed or removed.

Code: BK = black BN = brown BU = blue GN = green YE = yellow GY = grey PK = pink WH = white



## Accessories | Assembly parts

### Lock nuts, brass-nickel - plated

ID-NO.	Z00106	Z00107	Z00114	Z00109	Z00110
Nut thickness [mm]	4	4	4	5	5
Thread	M12x1	M18x1	M22x1	M30x1.5	M38x1.5
Spanner size	17	24	27	36	50

### Lock nuts, stainless steel

ID-NO.	Z01098	Z00112	Z00113	Z00115
Nut thickness [mm]	4	4	4	5
Thread	M8x1	M12x1	M18x1	M30x1.5
Spanner size	13	17	24	36

### Lock nuts, plastics

ID-NO.	Z00180	Z00120	Z00117	Z00118	Z00119	Z01092	Z01052
Nut thickness [mm]	6	8	4	5	5,5	8	8
Thread	M14x1	M30x1.5	M12x1	M18x1	M30x1.5	G 3/4	G 1
Spanner size	22	41	17	24	36	41	50
Material	PTFE	PTFE	PPE	PPE	PPE	PTFE	PTFE

### Central screw, polyamide

Z00104	M12, length 70 mm, hexagon socket 10 mm, material PA
Z00105	M16, length 90 mm, hexagon socket 14 mm, material PA

### MOUNTING CLAMPS

TYPE	ID-NO.	DIMENSIONS	DESIGN																		
KLS 20 KLS 34	Ø 20 Ø 34	Z00100 Z00102	Clamps of PA, for smooth-bodied switches																		
		<p>E: hexagon socket screw 1.4305</p>	<table border="1"> <thead> <tr> <th>F</th> <th>Ø 20</th> <th>Ø 34</th> </tr> </thead> <tbody> <tr> <td>A</td> <td>47</td> <td>61</td> </tr> <tr> <td>B</td> <td>30</td> <td>47</td> </tr> <tr> <td>C</td> <td>17</td> <td>15</td> </tr> <tr> <td>D</td> <td>32</td> <td>45</td> </tr> <tr> <td>E</td> <td>M5x30</td> <td>M5x50</td> </tr> </tbody> </table>	F	Ø 20	Ø 34	A	47	61	B	30	47	C	17	15	D	32	45	E	M5x30	M5x50
F	Ø 20	Ø 34																			
A	47	61																			
B	30	47																			
C	17	15																			
D	32	45																			
E	M5x30	M5x50																			
KLB 35	Ø 35	Z00125	Clamp of PTFE (Teflon), for smooth-bodied switches hexagon socket screw M5x40																		
		<p>hexagon socket screw 1.4571</p>																			
KBM 025 KBM 030 KBM 035	Ø 25 Ø 30 Ø 35	Z01189 Z01188 Z01187	Mounting clamp of aluminium																		
			<table border="1"> <thead> <tr> <th>Typ</th> <th>D</th> </tr> </thead> <tbody> <tr> <td>KBM 025</td> <td>Ø 25</td> </tr> <tr> <td>KBM 030</td> <td>Ø 30</td> </tr> <tr> <td>KBM 035</td> <td>Ø 35</td> </tr> </tbody> </table>	Typ	D	KBM 025	Ø 25	KBM 030	Ø 30	KBM 035	Ø 35										
Typ	D																				
KBM 025	Ø 25																				
KBM 030	Ø 30																				
KBM 035	Ø 35																				

# Sales partners, wholesalers and representatives



ARGENTINA, Lomas de Zamora  
AUSTRALIA, Warabrook NSW 2304  
AUSTRIA, Wien  
BELGIUM, Aalst  
BRAZIL, Sao Paulo  
CANADA, Oldcastle – Ontario  
CHINA, Shanghai  
COLOMBIA, Bogota D.C.  
CZECH REPUBLIC, Ostrava  
DENMARK, Aabenraa  
ESTONIA, Tallinn  
FINLAND, Jyväskylä  
FRANCE, Nanteuil les Meaux  
GREECE, Sindos - Thessaloniki

GREAT BRITAIN, Staffordshire  
HUNGARY, Budapest  
INDIA, Mumbai  
IRELAND, Clane, Co. Kildare  
ISRAEL, Tel-Aviv  
ITALY, Carate Brianza (MI)  
JAPAN, Tokyo  
NAMIBIA, Windhoek  
NETHERLANDS, LG Dordrecht  
NEW ZEALAND, Greenmount,  
Auckland  
NORWAY, Kolsås  
PHILIPPINES, Taguig City  
POLAND, Jezow Sudecki  
POLAND, Katowice

RUSSIAN FEDERATION, Moscow  
PORTUGAL, Porto  
ROMANIA, Bucharest  
SINGAPORE, Singapore  
SLOVAKIA, Banská Bystrica  
SLOVENIA, Ljubljana - Crnuce  
SOUTH AFRICA, Cleveland  
SOUTH KOREA, Gwangmyeongsi,  
Gyeonggi-do  
SPAIN, Nigran  
SWEDEN, Borås  
SWITZERLAND, Uster  
TAIWAN, New Taipeh City  
TURKEY, Kurtköy / Pendik / Istanbul  
USA, Gastonia  
VIETNAM, Ho Chi Minh City



<https://ege-elektronik.com/en/organisation/ege/>

We look forward to your enquiry.  
Please contact us!

EGE-Elektronik  
Spezial-Sensoren GmbH  
Ravensberg 34 • 24214 Gettorf • Germany  
T +49 (0) 4346-41580 F +49 (0) 4346-5658  
info@ege-elektronik.com  
**ege-elektronik.com**

E31120

