



# Metal Detectors



Special-Sensors for Automation

# Metal Detectors

## Technique & Application

### Application notes

The metal detector System 3000 is designed to detect medium size and larger pieces of metal. The system has a very effective means of adjusting sensitivity. When used with the MU 3300 amplifier, it will respond at the highest level of sensitivity to medium size parts like nails, washers, or pieces of flatware. When used with the MDV amplifier, it will respond only to larger pieces of metal like teeth from an excavator bucket, tools, or metal paneling. If not discovered, these items could destroy stone-crushing machines, vibratory equipment, or wood-chipping machines. When used in this manner, the metal detector is suitable for protecting machinery, whereby smaller parts will not interrupt operation of the equipment. It detects metal during bulk material transport by means of contactless measurement.

The System 3000 consists of an amplifier and an inductive detector coil. The amplifier is equipped with an automatic adjustment regulator that ensures reliable operation even when disturbing metal parts are in close proximity to the detector coil. In addition, the adjustment regulator also ensures that only metal parts that are in motion will be detected.

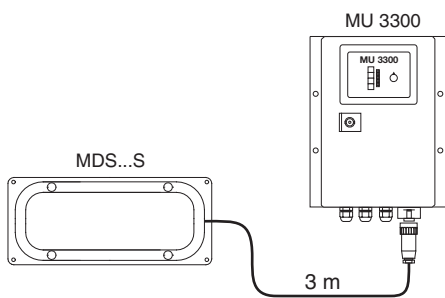

One of the amplifier's tasks is to process the signals emitted by the metal detector coil and convert them into an electronic pulse. The detector coil generates an electromagnetic field. As soon as a piece of metal passes by the coil, it disturbs that field, resulting in a signal that can be evaluated. The operator adjusts the metal detector's sensitivity on the potentiometer. The coil's sensitivity is dependent on several factors, including: the coil's

environment, the electromagnetic characteristics of the material to be detected, and the speed with which the material is transported.

The MU 3300 amplifier has a self-monitoring function. Any error that appears in the system will activate a separate output relay. The unit's electronics are installed in a robust metal housing that has a window for the functional display. The MDV 3172 and MDV 3220 amplifier are particularly well suited for use in difficult environments like those that involve dirt, temperature fluctuations, or vibration. These models therefore possess only the most critical adjustment and display functions.

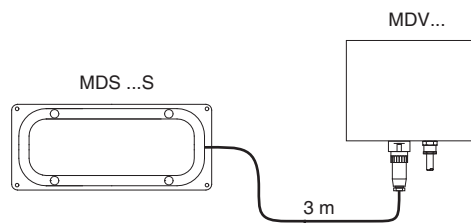

The detector coils are mounted with PVC columns on an aluminium baseplate that shields the coils from electromagnetic disturbances coming from the substructure. The baseplate simultaneously provides stability. Whenever the operator must arrange the detector coil in the presence of iron structural elements, he can use the aluminium plate to shield the coil.

It is preferable to arrange the detector coils underneath the material transport belts in order to minimize the chance of mechanical damage to the coil. The distance to the belt's transport rollers should be at least equal to the width of a coil. In order to most effectively exploit the metal detector's sensitivity, maintain a metal-free area around the detector coil approximately equal to 1.5 to 2 times the coil diameter. If the coil is installed in a hanging position above the transport belt, always make sure that no structural parts made of iron are too close to the coil and especially that they do not vibrate. If this cannot be avoided, it will be necessary to reduce the sensitivity. This

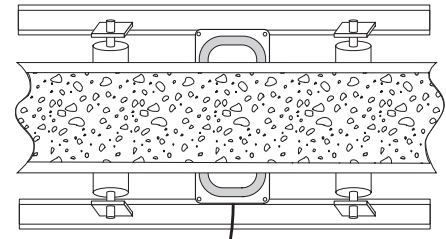

will consequently reduce the detection distance or may have the result that only large pieces of metal will be detected.

The detector coils have a special 3-meter long cable. If the distance between the detector coil and the amplifier is longer than 3 meters, connect these two units with the KS 031 DS... extension cable. The longest permissible distance is 50 meters. In order to ensure that the system will work properly at that distance, we recommend using the EGE special extension cable.

By using connection box MA 125 two detector coils can operate together with one amplifier MDV.../ MU... The maximum cable length between one coil and the connection box MA 125 is 3 m.

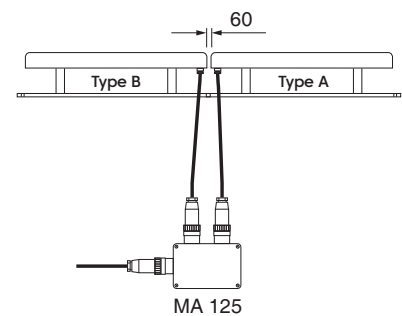

Mounting positions side by side

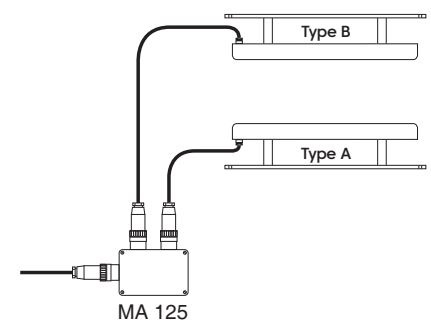

Mounting positions one upon the other



# Amplifier for detector coils

High sensitivity

Automatic adaption

Self monitoring function

Reset function

230 / 115 V AC



## Design MU 3300

### Dimensions

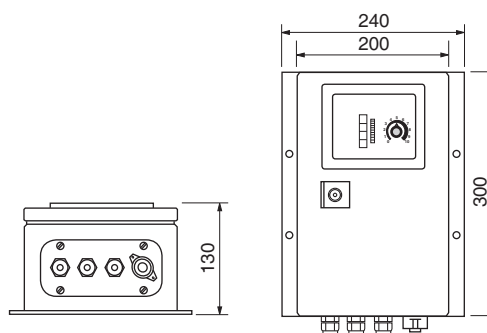

<b>ID-No.</b>	<b>P81012</b>
<b>Type</b>	<b>MU 3300</b>
<b>Supply voltage [V]</b>	<b>230 / 115 AC ±10%</b>
<b>Current consumption [mA]</b>	<b>&lt;60</b>
<b>Output</b>	<b>Relay / Change over contact</b>
<b>Switching voltage</b>	<b>250 V AC / 220 V DC</b>
<b>Switching current</b>	<b>4 A</b>
<b>Switching power</b>	<b>1000 VA / 60 W (cos φ = 1)</b>
<b>Ambient temperature [°C]</b>	<b>-20...+60</b>
<b>Time delay [s]</b>	<b>typ. 60</b>
<b>EMC class</b>	<b>A</b>
<b>Protection [EN 60529]</b>	<b>IP 65</b>
<b>Display</b>	<b>LED-array</b>
<b>Housing material</b>	<b>Steel</b>

Sensitivity diagram (steel cube ST 37)

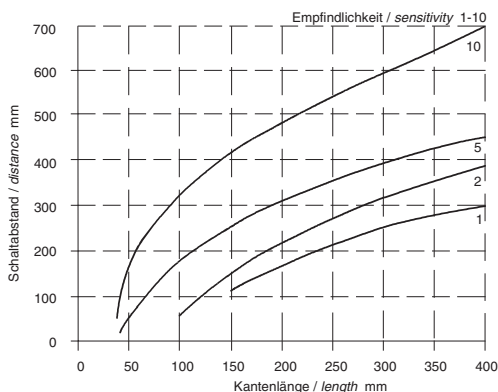

### Connections

Relay „Detection“ decays when metal is detected.

Metal detection is acknowledged with reset button.

Relay „Fault“ decays on fault condition.

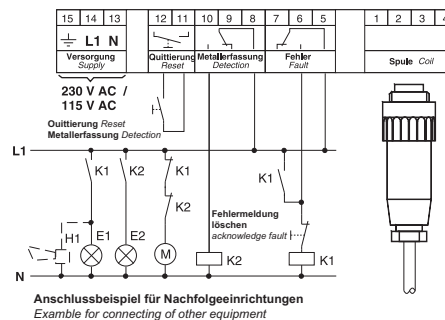

Anschlussbeispiel für Nachfolgeeinrichtungen  
Example for connecting of other equipment

Accessories

see page 8.7



# Amplifier for detector coils

Automatic regulation adaption

Waterproof IP 67

For detector coil with cable plug



## Design MDV 3172

### Dimensions

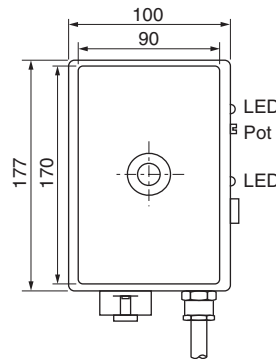

ID-No.	P81010	P81017	P81011
Type	MDV 3172 WR2	MDV 3172 WR1	MDV 3172 GR
Supply voltage [V]	230 AC ±10%	115 AC ±10%	24 DC ±10%
Current consumption [mA]	<20	<60	<100
Output	Relay / Change over contact		
Switching voltage	250 V AC / 220 V DC		
Switching current	1 A AC / 2 A DC		
Switching power	125 VA / 60 W		
Ambient temperature [°C]	-25...+70		
EMC class	A		
Protection [EN 60529]	IP 67		
Display	LED		
Housing material	PBT		
Connection	2 m PVC cable 7x0,5 mm <sup>2</sup>		

**Note:**

The amplifier MDV 3172 has a relay-change over-function. During metal detection, the relay is activated and contact 4-5 is closed (2-5 is open). After switch-on, the contact 5-4 is closed for 2 seconds. This can be used for testing purposes.

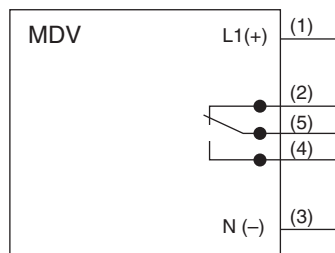

### Accessories Central screw M16x1 (Z00105) is part of delivery



# Amplifier for detector coils

Automatic regulation adaption

Waterproof IP 67

For detector coil with cable plug

With sensitivity adjustment knob

Test button



## Design MDV 3220

### Dimensions

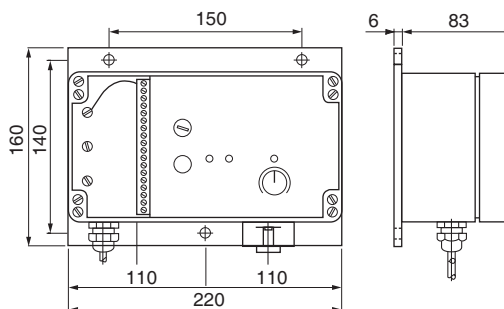

ID-No.	P81060	P81061
Type	MDV 3220 WR2	MDV 3220 GR
Supply voltage [V]	230 AC ±10%	24 DC ±10%
Current consumption [mA]	<20	<100
Output	Relay / Change over contact	
Switching voltage	250 V AC / 220 V DC	
Switching current	1 A AC / 2 A DC	
Switching power	125 VA / 60 W	
Ambient temperature [°C]	-25...+70	
EMC class	A	
Protection [EN 60529]	IP 67	
Display	LED	
Cable diameter [mm]	4...10	
Housing material	Aluminium	
Connection	Screw terminals	

Note:

With the potentiometer it is possible to adjust the sensitivity.  
 The amplifier MDV 3220 has a relay-change over-function. During metal detection, the relay is activated and contact 4-5 is closed (2-5 is open).  
 By pushing the test button it is possible to test the complete function of the MDV 3220.

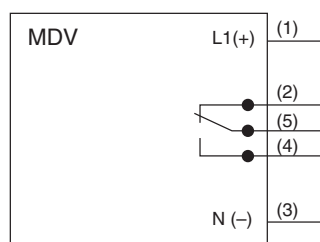
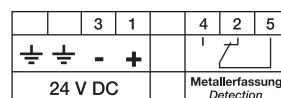
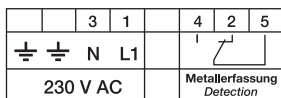



# Detector coils

Designed for outdoor use

Rugged construction

Substantially made



Design	MDS 3065-S		MDS 3095-S	
Dimensions				
Dimensions L1-L2-L3 [mm]	650-700-670		950-1000-970	
ID-No.	P81054	P81055	P81056	P81057
Type	MDS 3065-SA	MDS 3065-SB	MDS 3095-SA	MDS 3095-SB
Coil type	A	B	A	B
Ambient temperature [°C]	-25...+70			
Protection [EN 60529]	IP 67			
Housing material	PBT / Aluminium plate			
Connection	3 m PUR cable with cable plug			

Sensitivity diagram (steel cube ST 37)

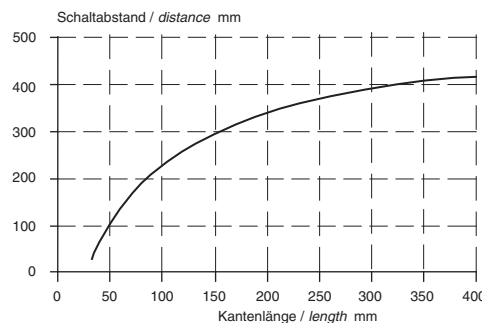

Maximum sensitivity for detector coil MDS 3065 with MDV

**Note:**

When using two detector coils one coil must be coil type A and the other coil type B. The maximum detection width increases up to 1800 mm (see connection box MA 125, page 8.07).

The standard cable length for the connection cable of the detector coil is 3 m. The extension cable type KS031-DS has two plugs, which can be connected at the amplifier and also at the detector coil. The maximum length of the extension cable is 50 m.

Coils MDS 3065-S (P81007) and MDS 3095-S (P81009) are replaced by MDS 3065-SA (P81054) or MDS 3095-SA (P81056) respectively. The technical and mechanical specifications are unchanged.

Accessories	Extension cable KS031-DS..., see page 8.07
-------------	--



## Accessories

### Supply isolation unit NTG 251/255, DTG 24

Type	ID-No.	Design
NTG 251	P81030	230 V AC
NTG 255	P81032	115 V AC
DTG 24	P81053	24 V DC

The power supply isolation unit is connected between the power supply and the amplifier MDV... It limits the power supply overvoltage and therefore protects the amplifier against overloading. It is used wherever no overvoltage protection is available, where the power supply takes place via an overhead power transmission network or an unstabilised battery charger, or where high inductive loads, e.g. motors, are directly switched. The power supply isolation unit acts also as an interface filter. The floating changeover output contact is designed to be connected to a power relay. It is not suitable for high loads.



### Connection box MA 125

Type	ID-No.	Design
MA 125	P81058	Connection box

By using connection box type MA 125 two detector coils can operate together with one amplifier MU / MDV.... The maximum cable length between one coil and the connection box MA 125 is 3 m.

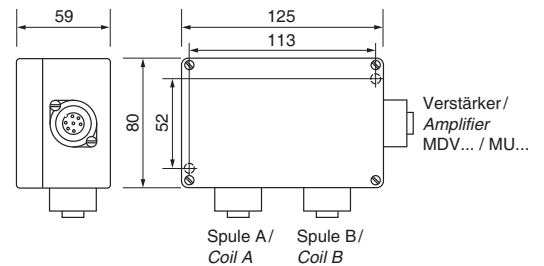
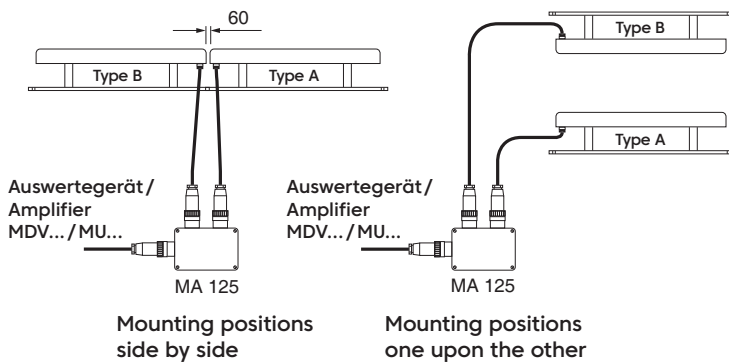

- Ambient temperature: -25 °C...+70 °C
- Protection: IP 67
- Housing material: Aluminium
- Connection: C16 plug-connection
- Mounting size: 52 x 113 mm

### Extensions cables KS031-DS

Type	ID-No.	Design
KS031-DS05	P81051	5 m IP 68
KS031-DS10	P81052	10 m IP 68
KS031-DSXX	S.....	max. 50 m

XX: Special length up to 50 m with plug connectors.

The KS031-DS... double-end cable connects in particular the detector coil with an extension cable (watertight) that has on its opposite end a plug for connecting to the MDV... or MU... amplifiers.

The KS031 special connection cable is specially designed for use with the Series 3000 of metal detectors. Due to its solid construction and resistant polyurethane sheath, it will not generate any disturbances that could initiate an error signal in the amplifier.

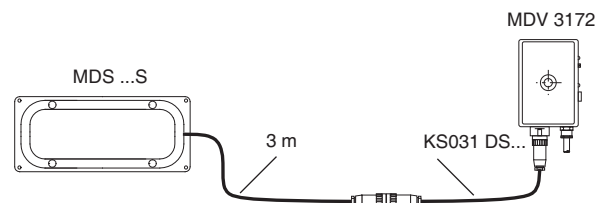

# Sales partners, wholesalers and representatives



ARGENTINA, Lomas de Zamora  
AUSTRALIA, Warabrook NSW 2304  
AUSTRIA, Wien  
BELGIUM, Aalst  
BRAZIL, Sao Paulo  
CANADA, Oldcastle – Ontario  
CHINA, Shanghai  
COLOMBIA, Bogota D.C.  
CZECH REPUBLIC, Ostrava  
DENMARK, Aabenraa  
ESTONIA, Tallinn  
FINLAND, Jyväskylä  
FRANCE, Nanteuil les Meaux  
GREECE, Sindos - Thessaloniki

GREAT BRITAIN, Staffordshire  
HUNGARY, Budapest  
INDIA, Mumbai  
IRELAND, Clane, Co. Kildare  
ISRAEL, Tel-Aviv  
ITALY, Carate Brianza (MI)  
JAPAN, Tokyo  
NAMIBIA, Windhoek  
NETHERLANDS, LG Dordrecht  
NEW ZEALAND, Greenmount,  
Auckland  
NORWAY, Kolsås  
PHILIPPINES, Taguig City  
POLAND, Jezow Sudecki  
POLAND, Katowice

RUSSIAN FEDERATION, Moscow  
PORTUGAL, Porto  
ROMANIA, Bucharest  
SINGAPORE, Singapore  
SLOVAKIA, Banská Bystrica  
SLOVENIA, Ljubljana - Crnuce  
SOUTH AFRICA, Cleveland  
SOUTH KOREA, Gwangmyeongsi,  
Gyeonggi-do  
SPAIN, Nigran  
SWEDEN, Borås  
SWITZERLAND, Uster  
TAIWAN, New Taipeh City  
TURKEY, Kurtköy / Pendik / Istanbul  
USA, Gastonia  
VIETNAM, Ho Chi Minh City



<https://ege-elektronik.com/en/organisation/ege/>

We look forward to your enquiry.  
Please contact us!

EGE-Elektronik  
Spezial-Sensoren GmbH  
Ravensberg 34 • 24214 Gettorf • Germany  
T +49 (0) 4346-41580 F +49 (0) 4346-5658  
info@ege-elektronik.com  
**ege-elektronik.com**

EE81120

