

EcoRich R

A fusion of hydraulic and motor/inverter technologies

Drastically improved functions on top of the energy saving features of the IPM motor



INDEX

Hybrid hydraulic system Model list P.1

System configuration System for saving energy P.2

Features P.3

Description of function Optional functions P.4

Nomenclature Specifications Representative pressure – flow rate characteristics P.5

External dimension diagram P.6

Wiring guide P.7

Case studies of energy savings P.8

Energy-saving technologies supporting the hybrid hydraulic system P.9

Handling of EcoRich R P.10

Excluded from high-efficiency motor regulations

Hybrid hydraulic system **Model List**

Diverse specifications for machine variations.
Daikin's hybrid hydraulic system lineup provides a variety of functions and capacities depending on the machine type.

		Equivalent to 0.75 kW	Equivalent to 1.5 kW	Equivalent to 2.2 kW	Equivalent to 2.8 kW	Equivalent to 3.7 kW	Equivalent to 5.0 kW	Equivalent to 7.0 kW	Equivalent to 11.0 kW
For machine tools	EcoRich	EHU14-L04	EHU25-L04	EHU25-L07	EHU25-M07	3.7	5.0	7.0	11.0
	EcoRich R	0.75	1.5	EHU15R-M07 16 PQ, C, A	EHU30R-M07 16 PQ, C, A	3.7	5.0	7.0	11.0
	Super EcoRich	0.75	EHU30S-M075R Idle	2.2	2.8	3.7	5.0	7.0	11.0
For general industrial machines	Super Unit	0.75	1.5	SUT03S1507 16 PQ, C, A	SUT03S3007 SUT03S1510 16 PQ, C, A	SUT03S4007 SUT03S3010 SUT03S1516 SUT06D4016 16 PQ, C, A	SUT06S6007 SUT06S3016 SUT06D6021 SUT10D6021 16 PQ, C, A	SUT10S8007 SUT10D8021 SUT16D8021 16 PQ, C, A	P-SUT20D11KW 16 PQ, C
	Tankless type	0.75	1.5	SUT00S1507 16 PQ, C, A	SUT00S3007 SUT00S1510 16 PQ, C, A	SUT00S4007 SUT00S3010 SUT00S1516 SUT00D4016 16 PQ, C, A	SUT00S6007 SUT00S3016 SUT00D6021 16 PQ, C, A	SUT00S8007 SUT00D8021 16 PQ, C, A	SUT00S11007 SUT00D11021 16 PQ, C, A



16-pattern P-Q control



Communication function



Analog command input
*Only applicable to single pumps.



Idling stop

	Model	Rated capacity	Maximum operating pressure (MPa)						Maximum discharge rate (L/min)								Tank capacity (L)				
			4	5	6	7	10	15	20	10	20	30	40	50	60	70		80	90	100	110
EcoRich R	EHU15R-M0701	Equivalent to 2.2 kW	7.0																		10
	EHU15R-M0702		7.0																		
	EHU30R-M0701	Equivalent to 2.8 kW	7.0																		10
	EHU30R-M0702		7.0																		

* The above motor capacities are given for guidance only and do not represent the standard capacities of general motors.

Excellent energy savings are already a standard feature. Daikin's hybrid hydraulic system is also equipped with additional valuable functions.

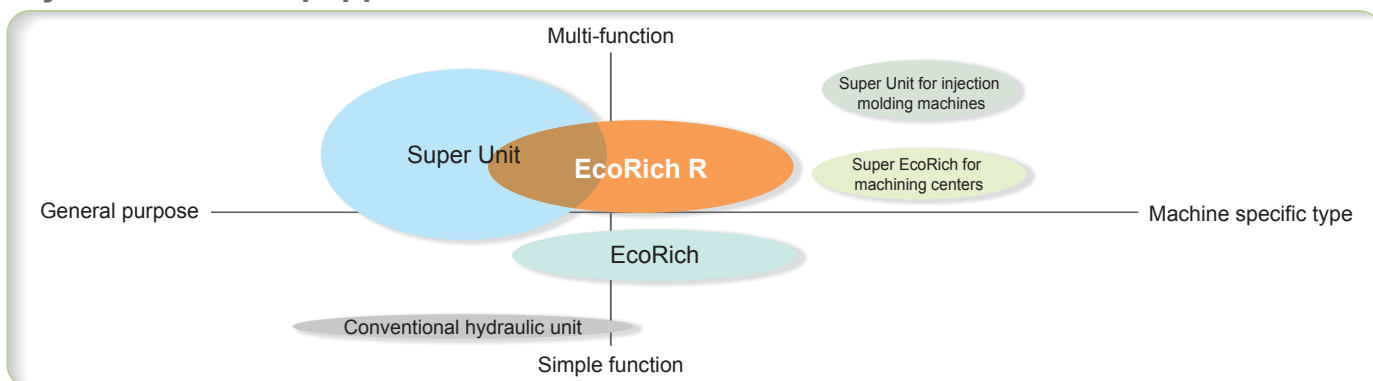

System configuration

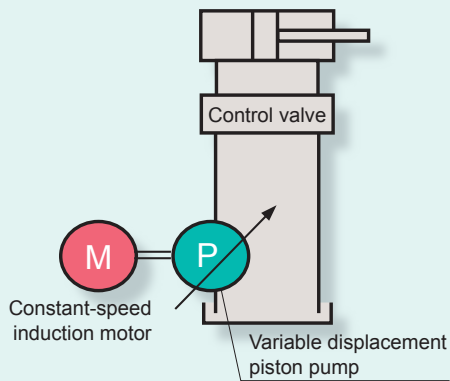

Conventional hydraulic system

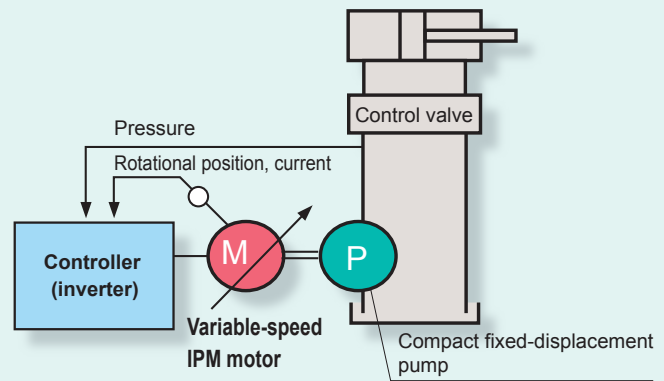

EcoRich R system

Energy-saving and low heat/noise generation

- ◆ The high-efficiency IPM motor is always controlled to run at an optimum speed with the inverter technology, eliminating unnecessary energy consumption.
- ◆ The motor is controlled at the minimum required rotation speed to prevent unnecessary oil temperature rise and suppress deterioration of the hydraulic oil.
- ◆ Running the motor at the minimum required rotation speed through inverter control achieves a remarkable noise level reduction in the pressure holding mode.

Easy installation and operation

- ◆ EcoRich R is ready for operation by simply supplying commercial 3-phase AC 200 V power.
- ◆ The pressure and flow rate can be set with simple key operations.
- ◆ Clear digital indication of pressure and flow rate settings and operation status.

System for saving energy

Operating pattern of hydraulic system and energy savings

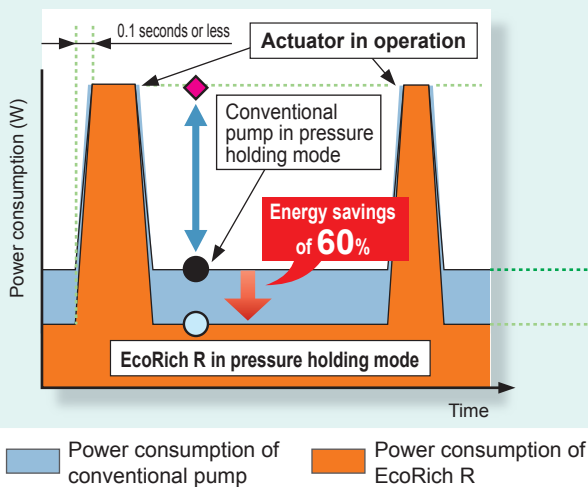

Operation outline

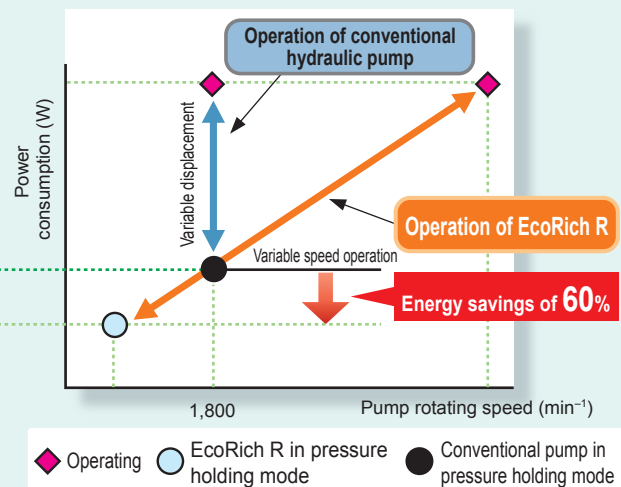

Autonomous energy-saving pressure and flow rate control

- ◆ The pressure is always monitored to supply hydraulic oil at the optimum flow rate as required according to the load condition.
- ◆ The IPM motor* runs at the minimum required rotation speed in the pressure holding mode and it rotates at a high speed to supply hydraulic oil at the required flow rate when operating a hydraulic actuator.

* Refer to Page 9 for details on the IPM motor.

Features

Feature 1 Further energy savings with high-efficiency IPM motor installed.

The system uses an ultra energy-saving IPM motor*, featuring a combination of magnet torque (pull-in and repulsive force between a coil and permanent magnet) and reluctance torque (pull-in force between a coil and iron).

*IPM motor: Interior Permanent Magnet Synchronous Motor
Refer to Page 9 for details on the IPM motor.

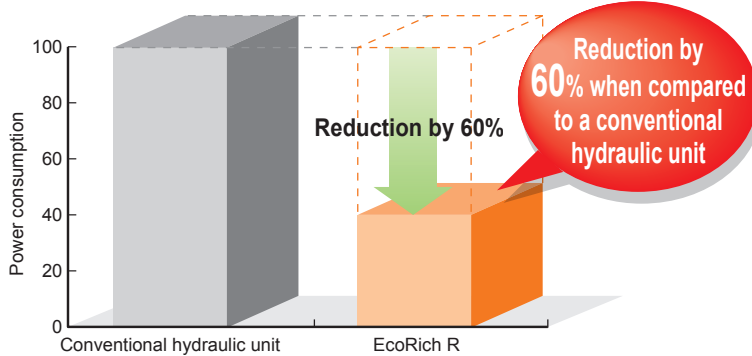

High torque and high efficiency due to a unique structure with rare-earth magnet embedded deep in the rotor

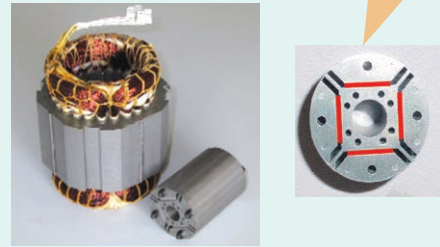

Feature 2 Low noise level at 50 dB (A) achieved in the pressure holding mode

A low noise level in comparison with conventional hydraulic units is achieved. It is 50 dB (A) in the pressure holding mode at 7 MPa and to 70 dB (A) or lower even over the full operation range.

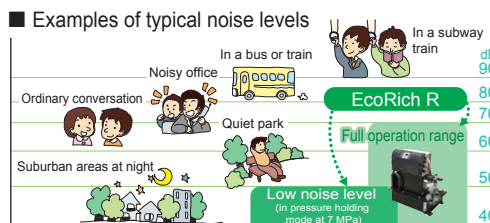

It is generally known that ordinary conversation can be conducted with a person one meter away in an environment at a noise level of 60dB (A).

Feature 4 NEW All models conforming to CE standards

All models conform to the machinery directive, EMC directive, and low voltage directive to facilitate CE approval of the main machine.

Feature 6 Monitoring oil level drop in the tank

The unit incorporates a dry run error detection function. Operation automatically stops when the oil level in the tank drops lower than a certain level. This prevents the pump from running while dry and helps to extend the service life.

Feature 3 EcoRich R is excluded from high-efficiency motor regulations.

High-efficiency motor regulations came into effect in Japan in April 2015. These regulations apply to the hydraulic units equipped with general motors but the EcoRich R that incorporates a dedicated inverter driven motor are excluded from them.

Advantages of adopting a hybrid hydraulic unit

- 1 Eliminates the need for replacement of motors for each destination
- 2 Eliminates the need for design changes in accordance with amendments to the regulations
- 3 Reduces design changes to spare parts, and the maintenance workload

Feature 5 NEW Multi-step pressure/flow rate control variations increased to sixteen patterns

Multi-step pressure and flow rate control can be realized simply by inputting sixteen patterns of pressure and flow rate settings and selecting a pattern using external input signals. Shockless adjustment upon switching can be achieved by changing the acceleration/deceleration time using parameters.

Feature 7 Simple monitoring of operating status

The pressure, flow rate, motor speed and other internal data can be monitored and displayed in graph form at a personal computer using Hybrid-Win*. This data can be displayed collectively, making it easy to grasp the operating status.

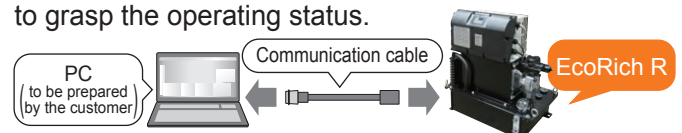

* Hybrid-Win is utility software for a PC to monitor the internal status of Daikin hybrid systems. The software and its instruction manual can be downloaded from the website "http://www.daikinpmc.com/" free of charge by completing the user registration process.
* The communication cable is available as an option.
* Some models require a dedicated separate monitor harness.
* It is possible to connect to a smart phone or factory LAN by adding an optional WiFi module. This is useful to facilitate the user's daily inspection/maintenance work and for remote monitoring.

Description of function

16 pressure (P) - flow rate (Q) setting patterns are available for cylinder control.

- The proportional control valve and proportional pressure control valve, which are utilized in conventional actuator circuits, can be omitted.
- The pressure and flow rate can be set using the control unit's operation panel.
- The pressure and flow rate settings can be selected from among the 16 patterns using external input signals.
- The EcoRich R autonomously switches between the pressure control and flow rate control modes.

Shockless switching of flow rates and pressures

- Setting the acceleration/deceleration time can reduce shocks when flow rates and pressures are changed.

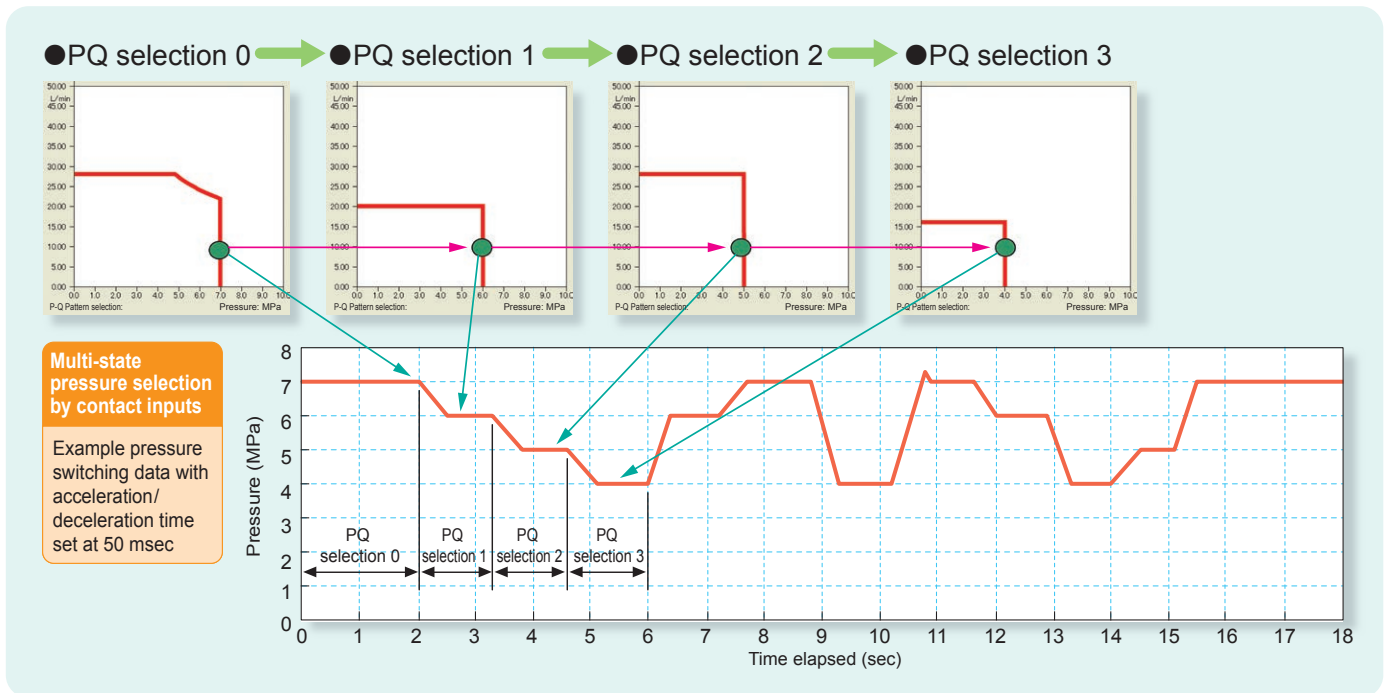

Optional functions

Function Option



Communication function



Analog command input

◆ Remote control and setting changes are possible through RS232C serial communication.

Using a commercially-available PLC or touch panel display with RS232C communication capabilities, parameters for the pressure, flow rate, acceleration time, deceleration time and so on can be set and viewed at the machine. This facilitates control of speeds and pressurizing forces and enables a wide variety of machine operations.

◆ Enables continuous control of pressures and flow rates as required.

The pressure and flow rate can be controlled continuously at the desired values by inputting the pressure command voltage (0 to 10 V) and flow rate command voltage (0 to 10 V) from the machine side. This achieves a control system with a simple configuration for machinery that requires variable speed control or continuity of pressurizing forces.

Hardware Option

◆ Built-in DC reactor

- Appropriate when it is necessary to improve the power factor or reduce the harmonics of the power supply

◆ Separate power supplies for power system and control system

- When an error occurs, only the main power supply is shut down and control power supply continues to carry current, thereby enabling the alarm code and internal status on occurrence of an error to be checked on the operation panel or through serial communication.

Nomenclature



- | | | | |
|---|---|--|---|
| <p>1 Model No.
● EHU※※R: EcoRich R</p> <p>2 Pump maximum flow rate (discharge rate)
● 15: 15.2 L/min
● 30: 28.5 L/min</p> | <p>3 Maximum operating pressure
● M07: 7.0 MPa</p> <p>4 Tank capacity
● 01: 10 L
● 02: 20 L</p> | <p>5 Design No.
May change according to model changes</p> <p>6 Optional function
● C: With communication function (RS232C)
● P: With analog input function</p> | <p>7 Optional hardware
● 1: With DCL
● 2: Separate power supplies for power system and control system</p> <p>8 Non-standard No.</p> |
|---|---|--|---|

Specifications

Model code	EHU15R-M0701	EHU15R-M0702	EHU30R-M0701	EHU30R-M0702
Maximum operating pressure (MPa)	7.0			
Operating pressure adjustment range (MPa)	0.5 to 7.0			
Maximum flow rate *1 (L/min)	15.2		28.5	
Operating flow rate range (L/min)	2.5 to 15.2		3.5 to 28.5	
Motor capacity (kW)	Equivalent to 2.2 kW		Equivalent to 2.8 kW	
Tank capacity (L)	10	20	10	20
Power supply	3-phase, 200 V (50 Hz), 200 V (60 Hz), 220 V (60 Hz) (Permissible voltage fluctuation: ±10%)			
External input signal	5 channels, photo coupler insulation, DC 24 V (maximum of DC 27 V), 5 mA per channel			
External output signal	2 channels, photo coupler insulation, FET output, DC 24 V, 50 mA maximum per channel			
	Contact output: 1 channel, relay output, Contact capacity: DC 30 V, 0.5 A (resistance load), 1 common contact			
Rated current	200 V/50 Hz (A) 11.5		15.4	
	200 V/60 Hz (A) 11.3		15.1	
	220 V/60 Hz (A) 10.5		13.8	
No-fuse breaker capacity (A)	15		20	
Mass (hydraulic oil excluded) (kg)	37	38	39	40
Standard coating color	Black (Munsell code N1)			
Usable oil *2	Special mineral-oil based hydraulic oil/wear-resistant hydraulic oil • Viscosity grade: ISO VG32 to 68 • Viscosity range: 15 to 400 mm ² • Contamination: Within NAS class 10			
Tank oil temperature	0 to 60°C (Recommended operating temperature range: 15 to 50°C)			
Operating ambient temperature	0 to 40°C			
Storage ambient temperature	-20 to 60°C			
Humidity	85% RH maximum (no condensation)			
Installation site	Indoors (Be sure to secure with bolts, etc.)			
Altitude	1,000 m maximum			

- *1: • The maximum flow rate is the theoretical value, not the guaranteed value.
 • Refer to the Delivery Specification (outside drawing) for detailed specifications.
 • This hydraulic unit is equipped with built-in safety valves.
- *2: • Use of hydraulic oils other than mineral-oil base type (e.g. hydrous/synthetic), water-glycol hydraulic oil for example, is prohibited.

Representative pressure – flow rate characteristics

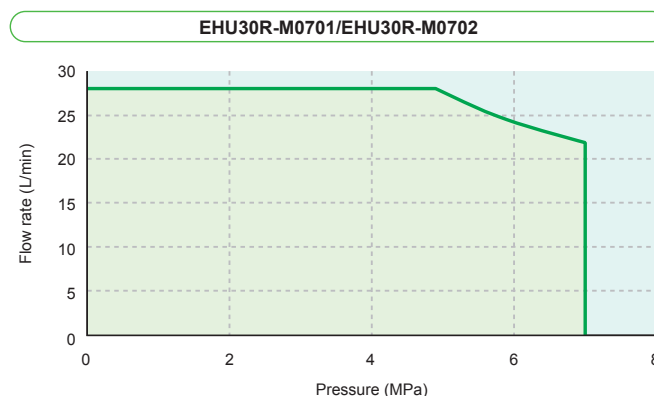
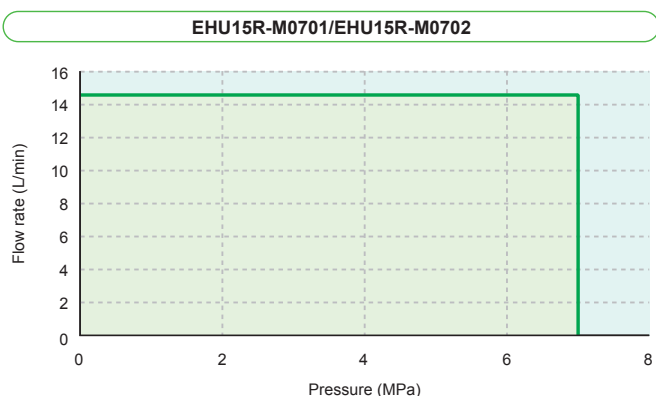

※The graph shows actual flow rates (representative values).
 ※Operating flow rate at the maximum pressure in continuous operation: EHU15R: 3 L/min maximum
 EHU30R: 5 L/min maximum

External dimension diagram

EHU15R-M0701, EHU30R-M0701

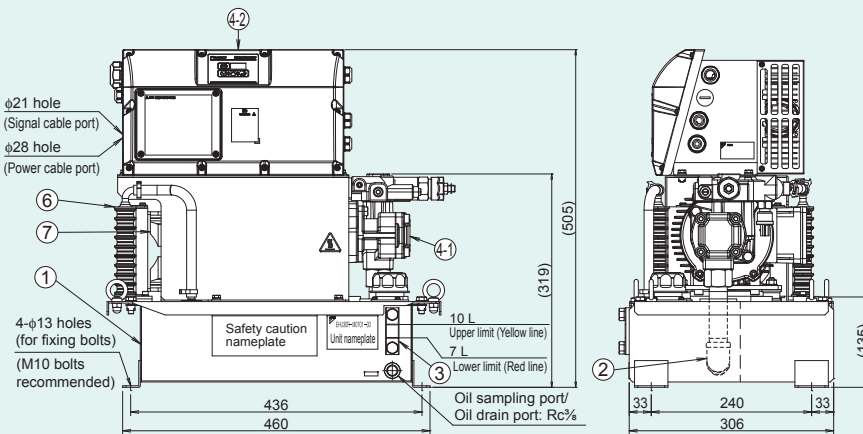
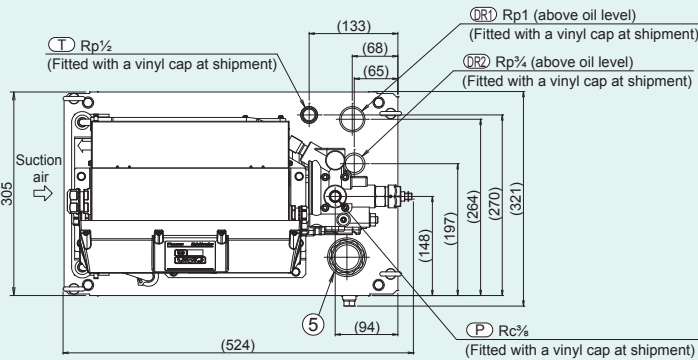

Do not place any obstacles to oil cooler air intake and exhaust within a distance of 100 mm from end faces of the unit. Install the unit at a location with good air flow so that heated air can be vented and take care about the temperature of the suction air; it must satisfy the stipulated condition for ambient temperature.

List of parts

Part No.	Name	Quantity
1	Oil tank	1
2	Suction strainer	1
3	Oil level gauge	1
4-1	Inverter driven motor pump	1
4-2	Controller	1
5	Oil filler port-cum-air breather	1
6	Oil cooler	1
7	AC fan	1

Hydraulic circuit diagram

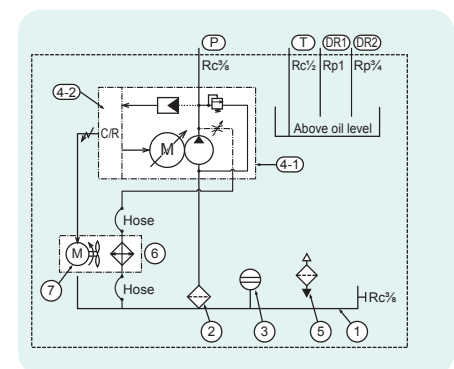

EHU15R-M0702, EHU30R-M0702

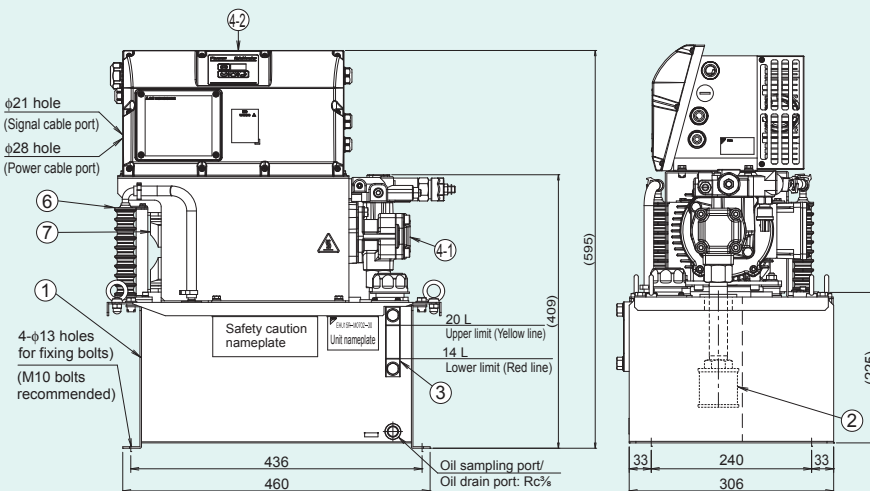
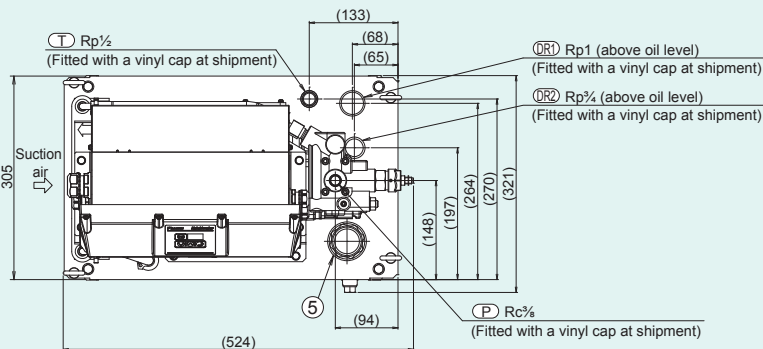

Wiring guide

EHU15R-M0701, M0702
EHU30R-M0701, M0702

Internal terminal layout (with the controller cover open)

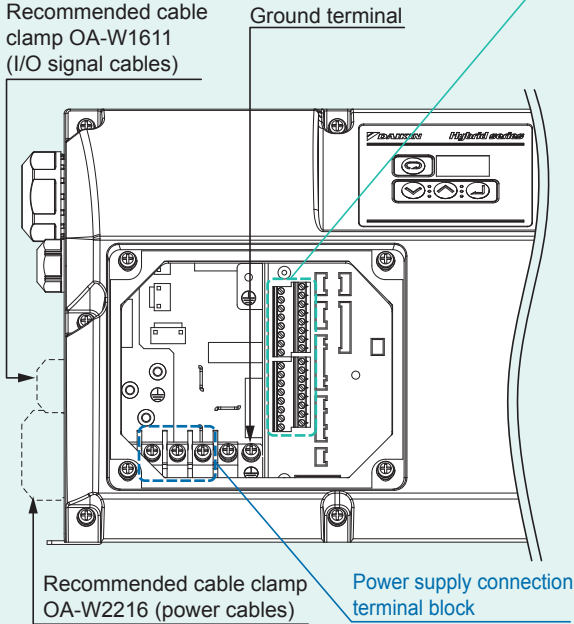

- * Main power supply connections:
Connect a 3-phase AC power supply (200 V/50 Hz, 200 V/60 Hz, or 220 V/60 Hz) to the power supply terminals (L1, L2 and L3), and connect a ground cable to the ground terminal.
- * I/O signal connections:
Connect wires to the I/O signal terminal block as shown in the table to the right.

Cable size	Recommended cable
2.5 mm ² or more (AWG14 or larger size)	CE362 2.5 mm ² × 4 wires (KURAMO ELECTRIC)
Recommended crimp terminal	Recommended cable clamp
RBV2-4 (NICHIFU)	OA-W2216 (OHM ELECTRIC) Applicable cable outer diameter: φ11 to φ16

I/O signal terminal block

Terminal	Terminal code	Type	Signal name	Remarks
I/O signal terminal block	AGND	Analog input/output	Analog ground	To be connected when using the optional analog input function
	AO2		Flow rate monitor output	
	AGND		Analog ground	
	AO1		Pressure monitor output	
	AGND		Analog ground	
	AIN2		Flow rate command input	
	AGND		Analog ground	
	AIN1		Pressure command input	
	A5V		Wiring disallowed	
	AL_C		Common contact output	
I/O signal terminal block	AL_B	Contact output	Contact output b	Connected to the common when the pressure switch is operating or on occurrence of an alarm or warning (Varies depending on the parameter setting.)
	AL_A		Contact output a	
I/O signal terminal block	OCOM	Digital output	Common digital output	This common terminal can be either positive or negative.
	DO7		Digital output 7	
	DO6		Digital output 6	
	DO5		Digital output 5	
	DO4		Digital output 4	
	DO3		Digital output 3	
	DO2		Digital output 2	
	DO1		Digital output 1	
	DIN8		Digital input 8	
	DIN7		Digital input 7	
I/O signal terminal block	DIN6	Digital input	Digital input 6	PQ selection 0 through 15 is allowed by combination of input signals.
	DIN5		Digital input 5	
	DIN4		Digital input 4	
	DIN3		Digital input 3	
	DIN2		Digital input 2	
I/O signal terminal block	DIN1	Digital input	Digital input 1	Runs or stops the unit. Runs/stop operation upon signal input can be selected with a parameter.
	ICOM		Common digital input	
I/O signal terminal block	GND	Serial communication (RS232C)	Digital ground	To be connected when using the optional communication function
	RXD		Received data	
	TXD		Sent data	

(Note) For details, refer to the unit's Instruction Manual.

Digital input/output signal connection

Digital input signal

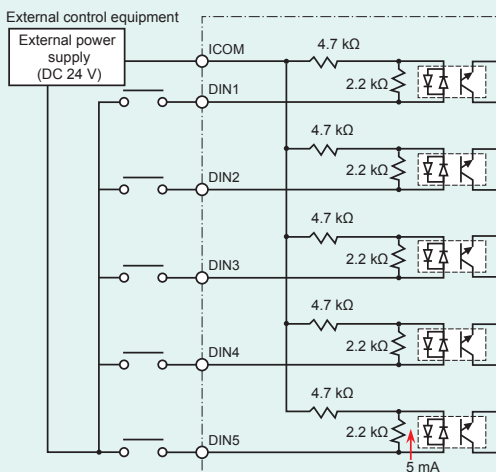

- * The digital input common terminal can be either positive or negative.
- * Prepare an external power supply (DC 24 V ± 1 V, 0.5 A or more).
- * The current of the input circuit is 5 mA per channel.

Digital output signal

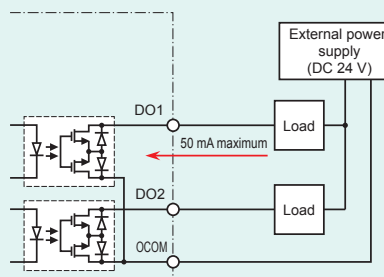

- * The digital output common terminal is negative.
- * Prepare an external power supply (DC 24 V ± 1 V, 0.5 A or more).
- * The maximum output current of the output circuit is 50 mA per channel.

Cable size	Recommended cable	Recommended cable clamp
0.5 to 0.3 mm ² (AWG20 to 22)	KVC-36SB 0.3 mm ² (KURAMO ELECTRIC)	OA-W1611 (OHM ELECTRIC) Applicable cable outer diameter: φ9 to φ11

Contact output signal

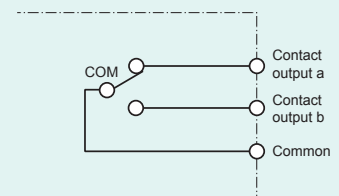

(The above figure shows the normal status of the relay contacts.)

- * The switching capacity of the contact output is DC 30 V, 0.5 A (at resistance load).
- * The minimum applicable load of the contact output is DC 10 mV, 10 μA, but this is only a guide to the lower limit where switching is possible with a minute load. The value varies depending on the switching frequency, environmental conditions, etc., so it is advisable to check the actual value.

Case studies of energy savings

Machining center

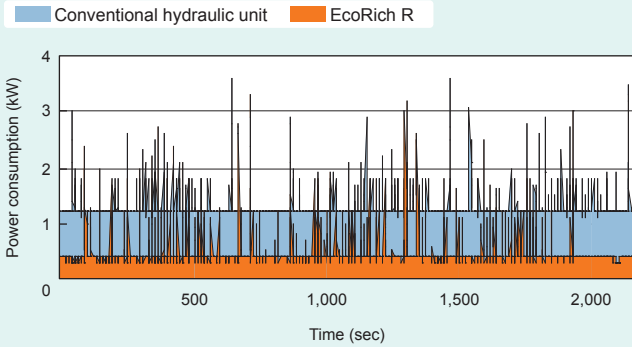

	Model	Pressure (MPa)	Tank capacity (L)
Conventional hydraulic unit	Piston pump	6.5	10
EcoRich R	EHU30R-M0701	6.5	10

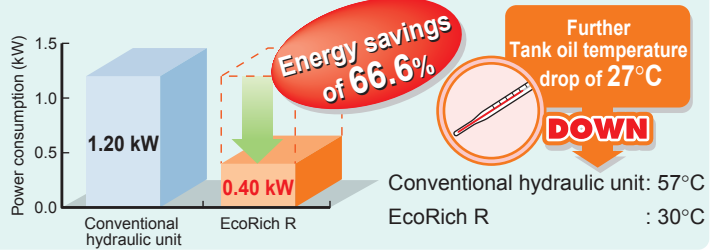

Hobbing machine

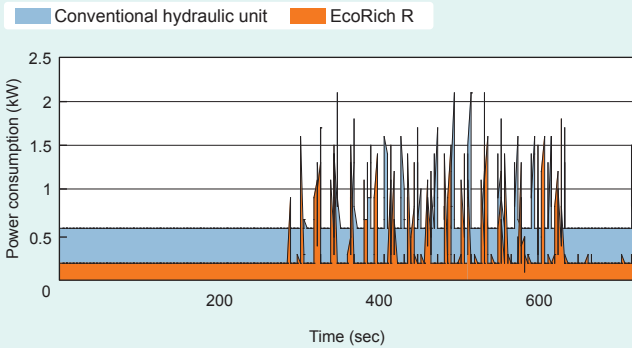

	Model	Pressure (MPa)	Tank capacity (L)
Conventional hydraulic unit	Piston pump	4.0	60
EcoRich R	EHU30R-M0702	4.0	20

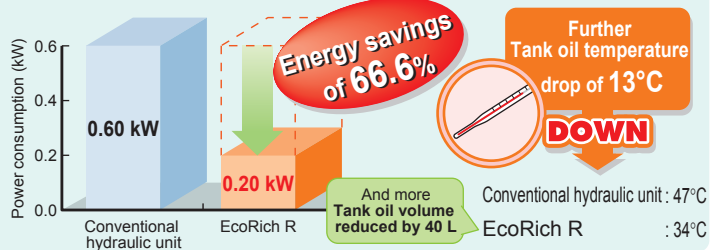

NC milling machine

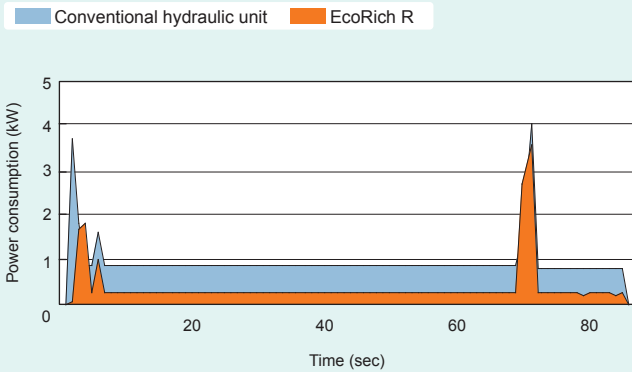

	Model	Pressure (MPa)	Tank capacity (L)
Conventional hydraulic unit	Piston pump	5.5	20
EcoRich R	EHU30R-M0702	5.5	20

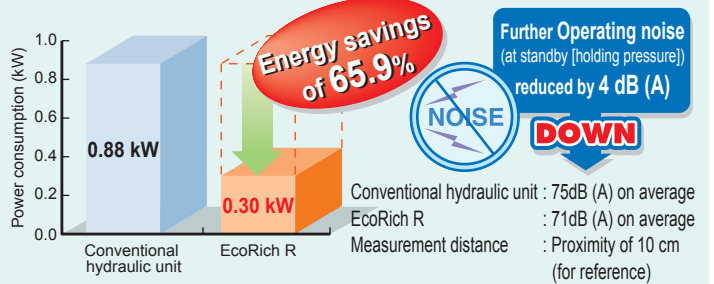

Thread grinding machine

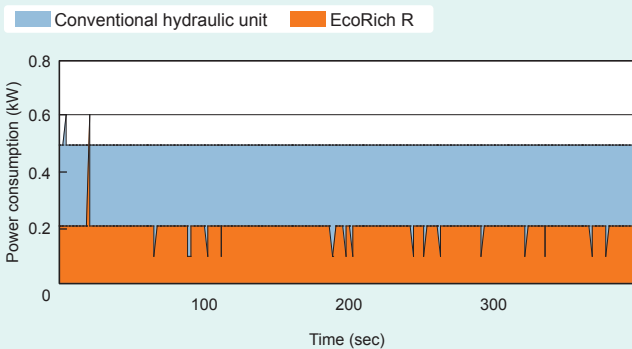

	Model	Pressure (MPa)	Tank capacity (L)
Conventional hydraulic unit	Variable vane pump	5.0	18
EcoRich R	EHU15R-M0701	5.0	10

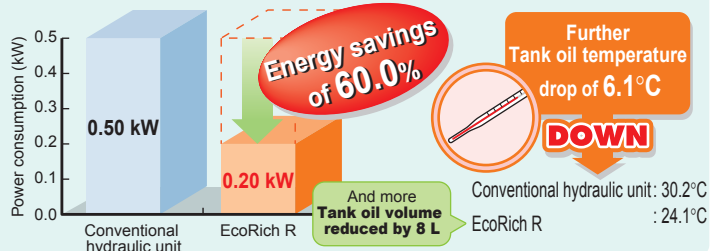

Energy-saving technology that supports hybrid hydraulic systems

- ◆ Daikin was the first in the industry to introduce an interior permanent magnet synchronous motor (IPM motor) into air conditioners for household use. Daikin was also an early adopter in the industry of the IPM motor for use in industrial-use air conditioners. We have led the industry as a front runner in air conditioner energy-saving performance.
- ◆ Hybrid products equipped with variable speed motors, developed by making full use of Daikin's original energy-saving motor technology and its production capacity, help to achieve energy savings for factory equipment

“Double torque” improves the energy-saving effect.

Combining two rotational forces, “magnetic torque” generated by a powerful neodymium magnet*1 and “reluctance torque”*2, generates more power with less electricity.

Powerful neodymium magnets, the key to this improved energy-saving effect!

Ferrite magnet Neodymium magnet



Neodymium magnets provide more power – substantially more than the ferrite magnets in general use.

*1: A compound of neodymium (Nd, rare-earth element), iron (Fe), and boron (B). Neodymium magnets are known to have superior magnetic properties.
*2: Rotational force generated by attractive force (reluctance = magnetic resistance) between iron and a magnet.

Fundamental Principle of the IPM Motor

With a rare-earth permanent magnet deeply embedded in the rotor, the IPM motor uses an electromagnetic structure that maximizes magnetic torque (attractive/repulsive force between the coil and permanent magnet) and reluctance torque (force of the coil that attracts iron). This structure achieves high torque and maximum efficiency while suppressing heat generation.

Structure of the IPM motor

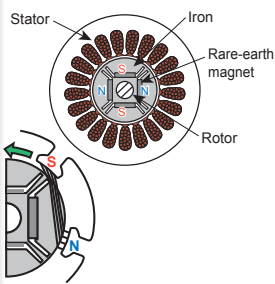

IPM motor
(Interior permanent magnet synchronous motor)

Since the magnetic field lines at the south pole side are made longer than those at the north pole side, the magnetic field lines at the south pole will try to shorten like a stretched rubber band contracts, resulting in rotational force due to reluctance torque in the direction indicated by arrow.

Structure of a conventional motor (AC servomotor)

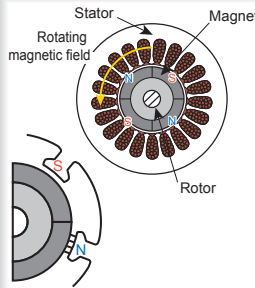

SPM motor
(Surface permanent magnet synchronous motor: e.g., servomotor, brushless DC motor)

The lengths of the magnetic field lines at the south and north poles are equivalent. Therefore, no reluctance torque that results in rotational force is generated.

Highly efficient even in the low-speed range

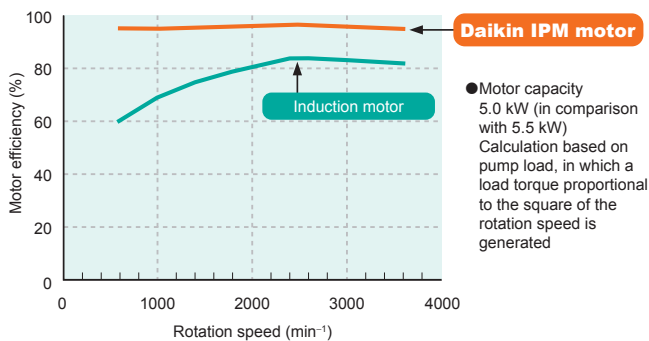

Large torque at low speed

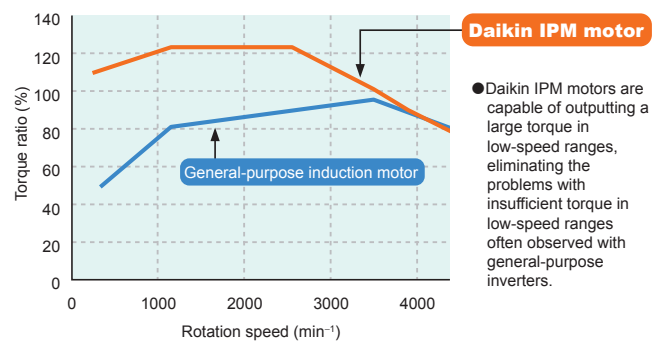



The following are the minimum requirements for use of the EcoRich R.
For details, refer to the unit's Instruction Manual.

● Ambient conditions

1. Ambient temperature: 0 to 40°C, ambient humidity: 85%RH maximum (with no condensation), altitude: 1,000 m maximum, to be used indoors

● Hydraulic oil

1. Use mineral-oil base hydraulic oil.
Use of hydraulic oils other than mineral-oil based type (e.g. hydrous/synthetic) is prohibited.
2. Use hydraulic oil equivalent to ISO VG32 to 68. Keep the viscosity of the hydraulic oil within the range from 15 to 400 mm²/s, and keep tank oil temperatures within the range from 0 to 60°C.
3. Keep contamination of hydraulic oil within NAS class 10.

● Installation and piping

1. EcoRich R mounts the motor pump using vibration-absorbing rubber to prevent vibration of the motor pump from being transmitted to the unit.
Use hoses for piping to the unit to provide flexibility.
2. The unit is a stationary type. Fix it with bolts on a level location that is free of vibration.
3. Keep obstacles that will obstruct air intake and emission at least 100 mm away from the end face of the unit.
Install the unit at a location with good air flow so that heated air can be vented.

● Electric wiring

1. Install a no-fuse breaker and a ground fault interrupter compliant with European Standard EN60947-2 in the main power supply of EcoRich R, to protect the electrical circuits against shorting and overcurrent, and to prevent electric shocks.
2. Use suitable electric cable in accordance with the power supply capacity.
3. Be sure to provide a ground connection with a grounding resistance of 100 Ω maximum, and connect the grounding wire directly with no breaker in the line.
4. Take care not to leave waste metal such as screws and cutting chips, combustible matter such as wood waste or oil, or wiring debris to enter inside the control unit.
5. Use a commercial power supply for the power source. The use of an inverter power supply may cause burn damage to the unit.

● Other precautions

1. If a failure occurs in the hydraulic unit, the system indicates an alarm and terminates.
If a failure or malfunction of this unit is expected to cause death or pose a danger to human beings, adopt appropriate safety measures in the facilities.
If this unit is applied in an important facility, also adopt appropriate safety measures in the facility to ensure that a failure of the equipment will not lead to a serious accident or loss.
2. EcoRich R mounts an IPM motor, which generates a counter-electromotive force during switching operation (regenerative operation).
Frequent switching under operating conditions that are likely to generate a counter-electromotive force may cause overloading of regenerative operation, which may cause the unit to stop.

DAIKIN INDUSTRIES, LTD.

Oil Hydraulic Equipment

Osaka Office

YODOGAWA PLANT

1-1, Nishi-Hitotsuya, Settsu, Osaka 566-8585, Japan

Phone: 81-6-6349-4475

Fax.: 81-6-6349-7862

Home Page: <http://www.daikinpmc.com/en/>