

Technical Information

Gear Motors

Group 1, 2, and 3

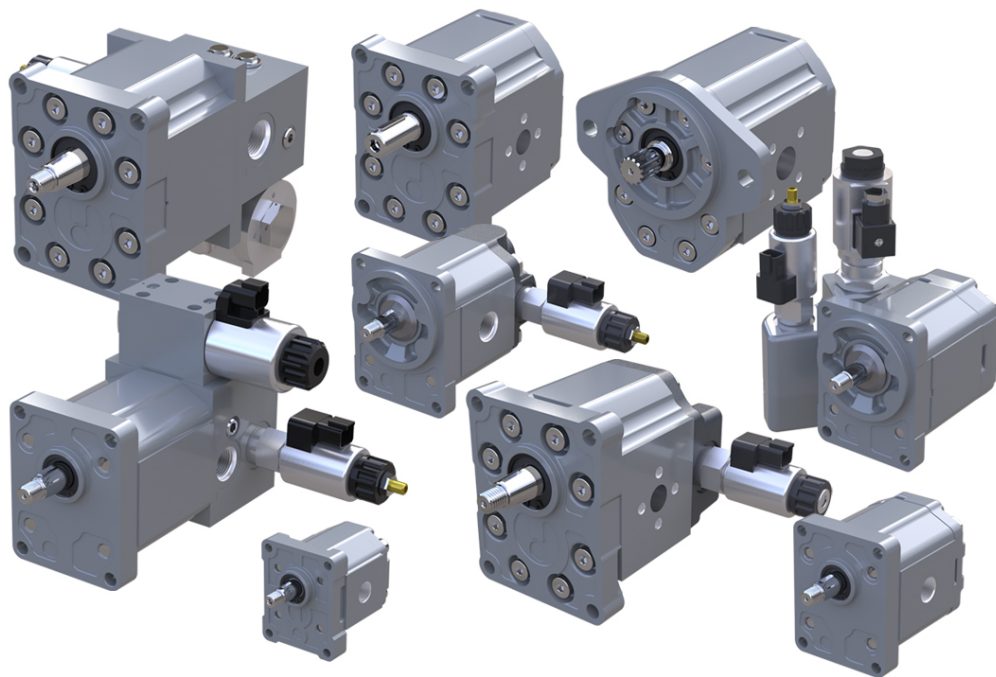

Revision history

Table of revisions

Date	Changed	Rev
October 2019	First edition	0101

Contents

General information

Overview.....	5
Features and benefits.....	7
Motor displacements.....	7
Determination of nominal motor size.....	8

System Requirements

Pressure.....	9
Speed.....	9
Hydraulic Fluids.....	10
Temperature and Viscosity.....	10
Filtration.....	11
Filters.....	11
Selecting a filter.....	11
Reservoir.....	11
Line sizing.....	12
Motor shaft connection.....	12
Motor shaft load data form.....	13
Motor Life.....	13

Group 1 Gear motors

Motor design.....	14
Technical data.....	15
Model code.....	16
A Family.....	16
B Displacement.....	16
C Rotation.....	16
D Project version (value representing a change to the initial project).....	17
E Mounting flange.....	17
F Drive Gear.....	17
G Rear cover.....	17
H Inlet size; I Outlet size.....	18
J Ports Pos & Spec Body.....	18
K Seals.....	19
L Screws.....	19
M Set valves.....	19
N Type of mark.....	19
O Mark position.....	19
Motor performance graphs.....	19
Flange, shaft and port configurations.....	22
Shaft options.....	23
Integral relief value - SKM1IN.....	23
Variant codes for ordering intergral relief valve.....	24
Ports dimensions.....	26
Dimensions.....	27
SKM1NN, SKU1NN, SNU1NN – 01BA.....	28
SKM1NN, SKU1NN – 02BB, 02FA.....	29
SKM1NN, SKU1NN – 06GA and 06SA.....	30

Group 2 Gear motors

Motor design.....	31
SNM2NN.....	31
SNU2NN.....	31
SKU2NN.....	32
Technical data.....	32
Model code.....	33
A Family.....	33
B Displacement.....	34
C Rotation.....	35
D Project version (value representing a change to the initial project).....	35
E Mounting flange.....	35

Contents

F Drive gear.....	35
G Rear cover.....	36
H Inlet size; I Outlet size.....	37
J Ports pos & Spec body.....	38
K Seals.....	39
L Screws.....	39
M Set valves.....	39
N Type of mark.....	39
O Mark position.....	39
Motor performance graphs.....	41
Flange, shaft and port configurations.....	43
Shaft options.....	44
Port dimensions.....	45
Integral relief valve - SNM2IN.....	47
Variant codes for ordering integral relief valve.....	48
Anti-cavitation check valve - SNM2GN.....	50
Integral relief valve and anti-cavitation check valve - SNM2JN.....	50
Outrigger bearing assembly - SNM2NN.....	51
Allowable shaft loads.....	52
Outrigger bearings 9A, 94, 9J, 9F, and 9H.....	54
Shaft dimensions.....	55
Dimensions.....	56
SNM2NN, SNU2NN – 01DA, 01FA and 01BA.....	56
SNM2NN, SNU2NN – 02DB and 02AA.....	57
SNM2NN, SNU2NN – 03CA.....	58
SNM2NN, SNU2NN–04DB/05DB and 04AA/05AA.....	59
SNM2NN, SNU2NN, SKU2NN – 06SA, 06GA.....	60

Group 3 Gear motors

Motor design.....	61
SNM3NN.....	61
SNU3NN.....	62
Technical data.....	62
Model code.....	63
A Family.....	63
B Displacement.....	64
C Rotation.....	64
D Project version (value representing a change to the initial project).....	64
E Mounting flange.....	64
F Drive Gear.....	65
G Rear Cover.....	65
H Inlet size; I Outlet size.....	66
J Ports pos & Spec body.....	67
K Seals.....	67
L Screws.....	67
M Set valves.....	67
N Type of mark.....	68
O Mark position.....	68
Motor performance graphs.....	68
Flange, shaft, and port configurations.....	72
Shaft and flange availability.....	73
Ports dimensions.....	74
Anti-cavitation check valve - SNM3GN.....	77
Dimensions.....	78
SNM3NN, SNU3NN – 01FA, 01DA and 01BA.....	78
SNM3NN, SNU3NN – 02FA, 02DB and 02AA.....	79
SNM3NN, SNU3NN – 03FB and 03BB.....	80
SNM3NN, SNU3NN – 06AA.....	81
SNM3NN, SNU3NN – 07BC, 07SA and 07GA.....	82

General information

Overview

The DanfossGear Motors is a range of peak performance fixed displacement hydraulic motors available in three different frame sizes: Group 1, Group 2, and Group 3, all as uni- and bidirectional version.

Constructed of a high strength extruded aluminum body with aluminum rear cover and aluminum front flange, all motors are balanced for exceptional efficiency and designed to ensure an excellent starting torque and, in the bidirectional version, to guarantee the ability to work with high back pressure and extremely low system pressure.

The flexibility of the range in each frame size combined with the high efficiency and low starting torque makes the Danfoss Gear Motors ideal for a wide range of applications sectors including on- and off-highway hydraulic fan drive systems, turf care, road bidge, fork lifts and municipal.

All the unidirectional motors have the same construction of the correspondent pump as well but, with inlet and outlet positioned at the opposite side for the same rotation.

Some representatives of gear motors

SKM1NN 06SA



SNM2NN9JDB



General information

SNM3NN01BA

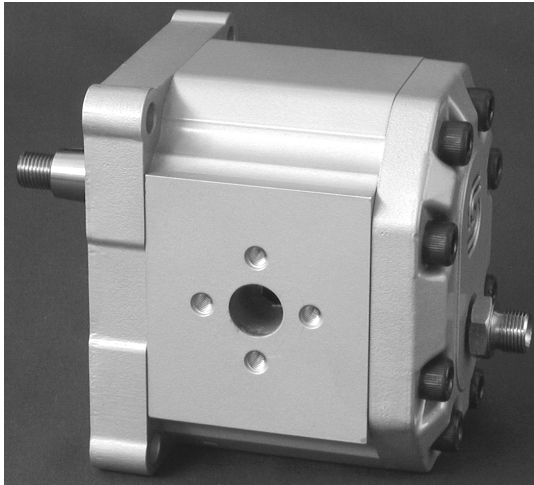

SNU2NN 06SA

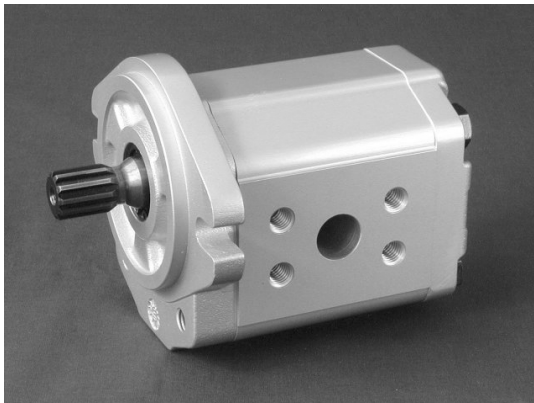

SNM3NL 07SA

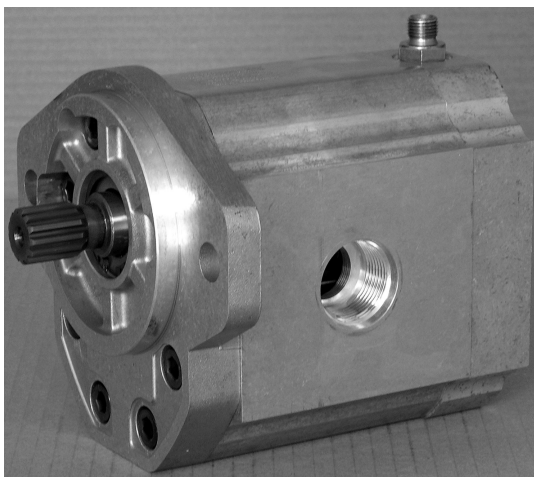

General information

SNU2NN 06GB

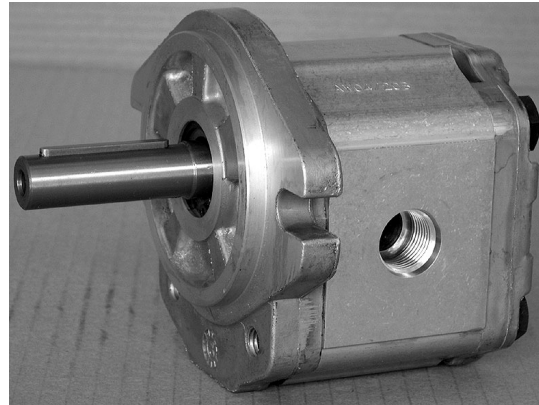

Features and benefits

- Three groups of frame sizes (Group 1, 2 and 3)
- Displacements from 2.6 to 90 cm³/rev [from 0.158 to 5.49 in³/rev]
- Available in uni- and bidirectional version for all the frame sizes, displacements and configurations
- Rated pressure up to 250 bar [3625 psi]
- Back pressure capability up to 250 bar [3625 psi]
- Speeds up to 4000 min⁻¹ (rpm) for Group 1 and 2, and up to 2500 min⁻¹ (rpm) for Group 3
- SAE, ISO and DIN mounting flanges and shafts
- Available with integrated relief valve in the Group 2 frame size and integrated anti-cavitation valve in Group 2 and Group 3 frame sizes

Motor displacements

Quick reference chart for unidirectional motor models (Group 1, 2 and 3)

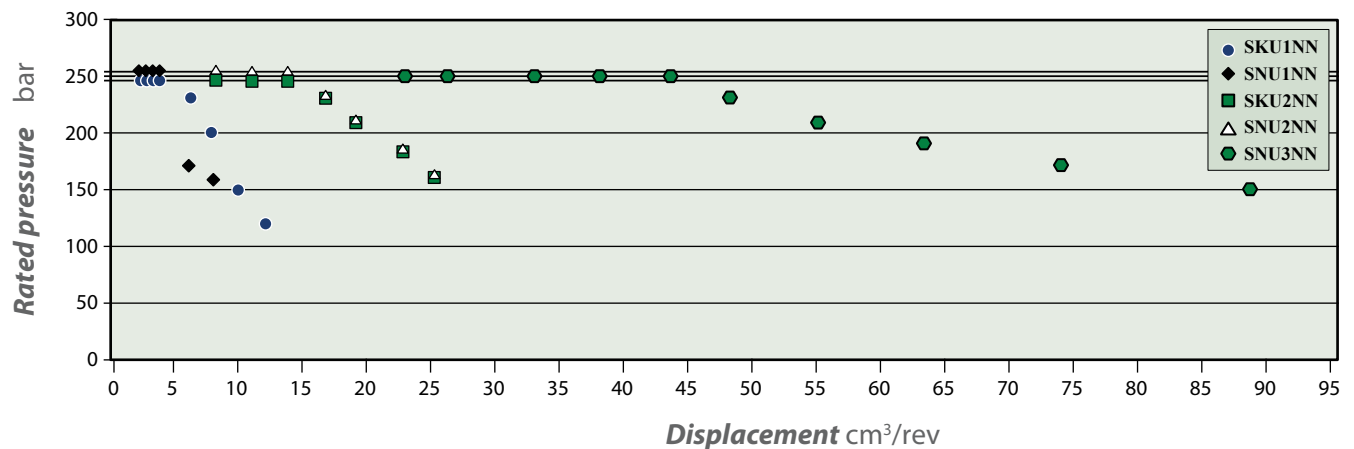

General information

Quick reference chart for bidirectional motor models (Group 1, 2 and 3)

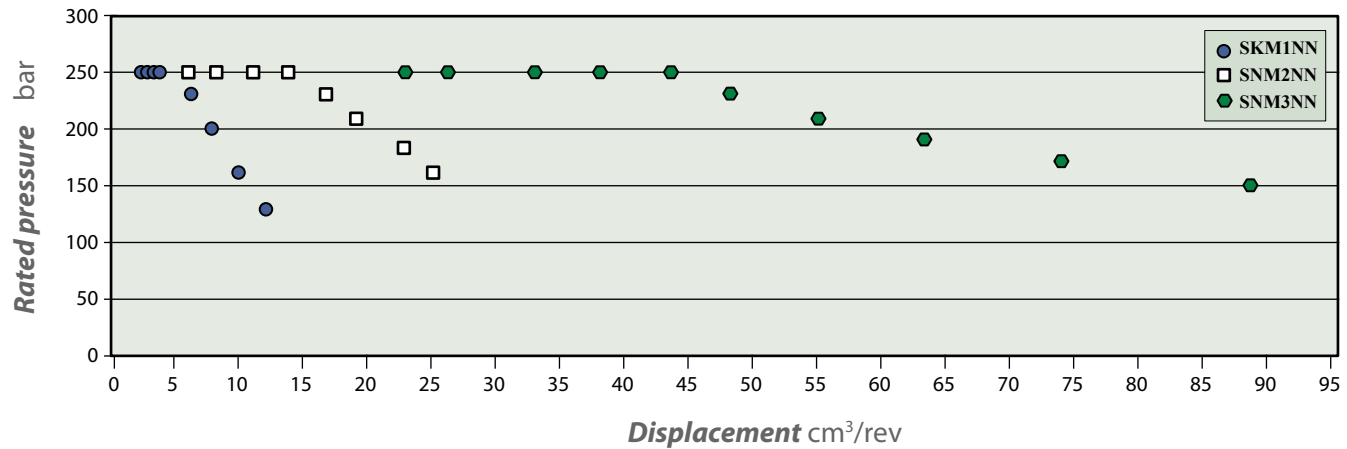

Determination of nominal motor size

Use these formulas to determine the nominal motor size for a specific application.

Based on SI units

$$\text{Input flow } Q = \frac{V_g \cdot n}{1000 \cdot \eta_v} \quad (\text{l/min})$$

$$\text{Output torque } M = \frac{V_g \cdot \Delta p \cdot \eta_m}{20 \cdot \pi} \quad (\text{N}\cdot\text{m})$$

$$\text{Output power } P = \frac{Q \cdot \Delta p \cdot \eta_t}{600} \quad (\text{kW})$$

$$\text{Motor speed } n = \frac{Q \cdot 1000 \cdot \eta_v}{V_g} \quad (\text{min}^{-1}(\text{rpm}))$$

Based on US units

$$\text{Input flow } Q = \frac{V_g \cdot n}{231 \cdot \eta_v} \quad (\text{US gal/min})$$

$$\text{Output torque } M = \frac{V_g \cdot \Delta p \cdot \eta_m}{2 \cdot \pi} \quad (\text{lb}\cdot\text{ft})$$

$$\text{Output power } P = \frac{Q \cdot \Delta p \cdot \eta_t}{1714} \quad (\text{hp})$$

$$\text{Motor speed } n = \frac{Q \cdot 231 \cdot \eta_v}{V_g} \quad (\text{min}^{-1}(\text{rpm}))$$

Variables SI units [US units]

V_g = Displacement per revolution	cm^3/rev [in^3/rev]
p_o = Outlet pressure	bar [psi]
p_i = Inlet pressure	bar [psi]
Δp = $p_o - p_i$ (system pressure)	bar [psi]
n = Speed	min^{-1} (rpm)
η_v = Volumetric eff. ciency	
η_m = Mechanical eff. ciency	
η_t = Overall eff. ciency ($\eta_v \cdot \eta_m$)	

System Requirements

Pressure

Peak pressure is the highest intermittent pressure allowed.

The relief valve overshoot (reaction time) determines peak pressure. It is assumed to occur for less than 100 ms.

The illustration to the right shows peak pressure in relation to rated pressure and reaction time (100 ms maximum).

Rated pressure is the average, regularly occurring operating inlet pressure that should yield satisfactory product life. The maximum machine load at the motor shaft determines rated pressure

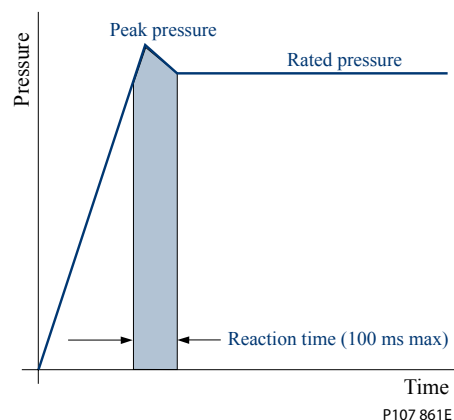

System pressure is the differential between the inlet and outlet ports. It is a dominant operating variable affecting hydraulic unit life. High system pressure, resulting from high load at the motor shaft, reduces expected life. System pressure must remain at, or below, rated pressure during normal operation to achieve expected life.

Back pressure is the average, regularly occurring operating outlet pressure that should yield satisfactory bidirectional motor life. The hydraulic load demand downstream of the motor determines the back pressure. Unidirectional motors cannot work with back pressure and the maximum back pressure allowed is 5 bar [72 psi] rated and 7 bar [101 psi] as peak.

Case Drain Pressure is the regularly occurring case drain line pressure that should yield satisfactory bidirectional motor life. It is recommended to design the case drain piping connecting the case drain direct to the tank in order to keep the case drain pressure as low as possible. The max. continuous case drain pressure allowed is 5 bar [72 psi] rated and 7 bar [101 psi] as peak.

Speed

Maximum speed is the limit recommended by Danfoss for a particular gear motor when operating at rated pressure. It is the highest speed at which normal life can be expected.

The lower limit of operating speed is the minimum speed. It is the lowest speed at which normal life can be expected.

The minimum speed increases as operating system pressure increases. When operating under higher pressures, a higher minimum speed must be maintained, as illustrated to the right.

System Requirements

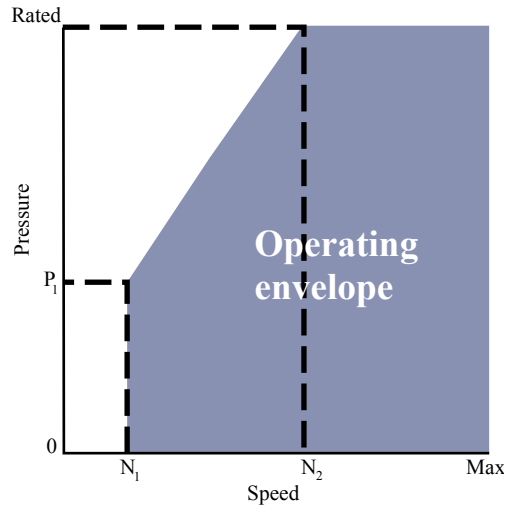

Hydraulic Fluids

Ratings and data for gear motors are guaranteed when the hydraulic system operates with premium hydraulic fluids without containing oxidation, rust, or foam inhibitors.

These fluids have to work with good thermal and hydrolytic stability to prevent wear, erosion, or corrosion of internal components. They include:

- Hydraulic fluids following DIN 51524, part 2 (HLP) and part 3 (HVL) specifications
- API CD engine oils conforming to SAE J183
- M2C33F or G automatic transmission fluids
- Certain agricultural tractor fluids

! Caution

Use only clean fluid in the gear motors and hydraulic circuit. Never mix hydraulic fluids.

Temperature and Viscosity

Temperature and viscosity requirements must be concurrently met. Use of petroleum/mineral-based fluids is highly recommended.

High temperature limits apply at the inlet port of the motors. The motors should operate at or below the maximum continuous temperature. The peak temperature is based on material properties.

Don't exceed it.

Minimum (cold start) temperature relates to the physical properties of component materials.

Cold oil, generally, doesn't affect the durability of motors components. It may affect the ability of oil to flow and transmit power. For this reason, keep the temperature at 16°C [60 °F] above the pour point of the hydraulic fluid.

Temperature limits

Minimum (cold start)	Maximum continuous	Peak (intermittent)
-20°C [-4°F]	80°C [176°F]	90°C [194°F]

Minimum viscosity occurs only during brief occasions of maximum ambient temperature and severe duty cycle operation.

Maximum viscosity occurs at cold start only. During this condition, limit speeds until the system warms up.

System Requirements

- Size heat exchangers to keep the fluid within these limits
- Test regularly to verify that these temperatures and viscosity limits aren't exceeded
- Keep the fluid viscosity in the recommended viscosity range for maximum unit efficiency and bearing life

Fluid viscosity limits

Maximum (cold start)	Recommended range	Minimum
1000 mm ² /s [4600 SUS]	12-60 mm ² /s [66-290 SUS]	10 mm ² /s [60 SUS]

Filtration

Filters

Use a filter that conforms to Class 22/18/13 of ISO 4406 (or better). It may be on the outlet (pressure filtration) or inlet (return line filtration).

Selecting a filter

When selecting a filter, please consider:

- Contaminant ingress rate (determined by factors such as the number of actuators used in the system)
- Generation of contaminants in the system
- Required fluid cleanliness
- Desired maintenance interval
- Filtration requirements of other system components

Measure filter efficiency with a Beta ratio (β_x). β_x ratio is a measure of filter efficiency defined by ISO 4572. It is the ratio of the number of particles greater than a given diameter (in microns) upstream of the filter to the number of these particles downstream of the filter.

- For suction filtration with controlled reservoir ingress, use a $\beta_{35-45} = 75$ filter
- For pressure or return filtration, use a filtration with an efficiency of $\beta_{10} = 75$

The filtration requirements for each system are unique. Evaluate filtration system capacity by monitoring and testing prototypes.

Fluid cleanliness level and β_x ratio

Fluid cleanliness level (per ISO 4406)	Class 22/18/13 or better
β_x ratio (suction filtration)	$\beta_{35-45} = 75$ and $\beta_{10} = 2$
β_x ratio (pressure or return filtration)	$\beta_{10} = 75$
Recommended inlet screen size	100 – 125 μm [0.004 – 0.005 in]

Reservoir

The **reservoir** provides clean fluid, dissipates heat, removes entrained air, and allows fluid volume changes associated with fluid expansion and cylinder differential volumes. A correctly sized reservoir accommodates maximum volume changes during all system operating modes. It promotes de-aeration of the fluid as it passes through, and accommodates a fluid dwell-time between 60 and 180 seconds, allowing entrained air to escape.

Minimum reservoir capacity depends on the volume required to cool and hold the oil from all retracted cylinders, allowing for expansion due to temperature changes. A fluid volume of 1 to 3 times the pump output flow (per minute) is satisfactory. The minimum reservoir capacity is 125% of the fluid volume.

Install the suction line above the bottom of the reservoir to take advantage of gravity separation and prevent large foreign particles from entering the line. Cover the line with a 100-125 micron screen. The pump should be below the lowest expected fluid level.

System Requirements

Put the return-line below the lowest expected fluid level to allow discharge into the reservoir for maximum dwell and efficient deaeration. A baffle (or baffles) between the return and suction lines promotes deaeration and reduces fluid surges.

Line sizing

Choose pipe sizes that accommodate minimum fluid velocity to reduce system noise, pressure drops, and overheating. This maximizes system life and performance.

Design inlet piping that maintains continuous pump inlet pressure above 0.8 bar absolute during normal operation. The line velocity should not exceed the values in the table below:

Maximum line speed

Inlet	Outlet	Return
5 m/s [16.4 ft/sec]	2.5 m/s [8.2 ft/sec]	3 m/s [9.8 ft/sec]

Most systems use hydraulic oil containing 10% dissolved air by volume. Under inlet vacuum conditions the oil releases the dissolved air. Moreover, when inlet vacuum is particularly severe, the hydraulic fluid may cavitate, causing adjacent metal surfaces to erode.

Warning

Over-aeration is the result of air leaks on the inlet side of the pump, and flow-line restrictions. This problem will not occur if inlet vacuum and rated speed requirements are maintained, reservoir size and location are adequate, adequate pipes size is used, avoiding sharp bends, or elbow fittings causing a reduction of flow line cross-sectional area.

Motor shaft connection

Shaft options for gear motors include tapered, splined, and parallel shafts.

Plug-in drives, with a splined shaft, can impose severe radial loads when the mating spline is rigidly supported. Increasing spline clearance does not alleviate this condition.

Use plug-in drives only if the concentricity between the mating spline and pilot diameter is within 0.1 mm [0.004 in]. Lubricate the drive by flooding with oil. A three-piece coupling minimizes radial or thrust shaft loads.

Motor shaft connection

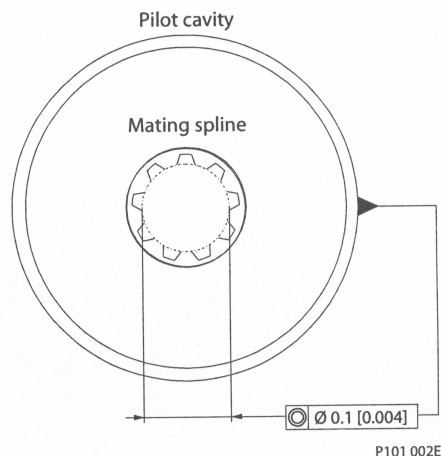

To avoid spline shaft damage, use carburized and hardened steel couplings with 80-82 HRA surface hardness.

System Requirements

Motor shaft load data form

Photocopy this page and fax the complete form to your Danfoss representative for an assistance. This illustration shows a motor with counterclockwise orientation:

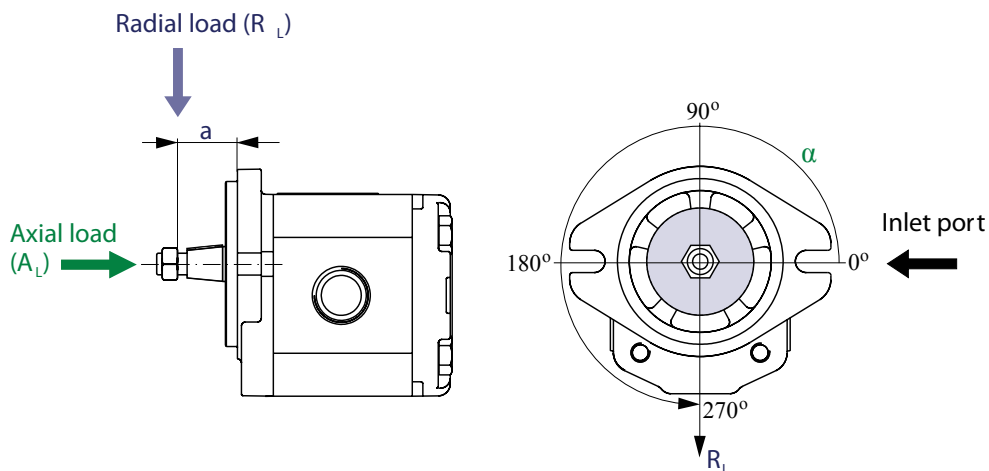

Application data

Item	Value	Based on SI or US units	
Motor displacement		<input type="checkbox"/> cm ³ /rev	<input type="checkbox"/> in ³ /rev
Rated system pressure		<input type="checkbox"/> bar	<input type="checkbox"/> psi
Peak pressure			
Motor shaft rotation		<input type="checkbox"/> left	<input type="checkbox"/> right
Motor minimum speed		min ⁻¹ (rpm)	
Motor maximum speed			
Radial load	R₁	<input type="checkbox"/> N	<input type="checkbox"/> lbf
Angular orientation of radial load to inlet port	α	degree	
Axial load	A₁	<input type="checkbox"/> N	<input type="checkbox"/> lbf
Distance from flange to radial load	a	<input type="checkbox"/> mm	<input type="checkbox"/> in

Motor Life

Motor life is a function of speed, system pressure, and other system parameters (such as fluid quality and cleanliness).

All Danfoss gear motors use hydrodynamic journal bearings that have an oil film maintained between the gear/shaft and bearing surfaces at all times. If the oil film is sufficiently sustained through proper system maintenance and operating within recommended limits, long life can be expected.

High pressure impacts motor life. When submitting an application for review, provide machine duty cycle data that includes percentages of time at various loads and speeds.

B₁₀ life expectancy number is generally associated with rolling element bearings. It does not exist for hydrodynamic bearings.

Danfoss strongly recommends a prototype testing program to verify operating parameters and their impact on life expectancy before finalizing any system design.

Group 1 Gear motors

Motor design

SKM1NN

SKM1NN is the Group 1 bidirectional motor available in the whole displacements range from 2.6 up to 12 cm³/rev [from 0.158 up to 0.732 in³/rev].

Configurations include European and SAE flanges and shafts (Code 01BA, 01DA, 02BB, 02FA, 06GA, 06SA).

SKM1NN 06SA

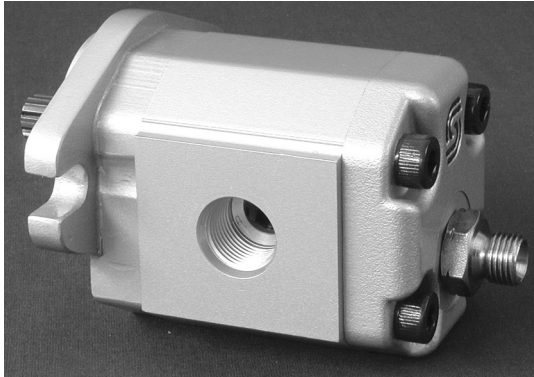

SKU1NN

SKU1NN is a Group 1 unidirectional motor available in the whole displacements range from 2.6 up to 12 cm³/rev [from 0.158 up to 0.732 in³/rev]. The SKU1NN motor construction is derived from the correspondent pump SKP1NN.

Configurations include European and SAE flanges and shafts (Code 01BA, 01DA, 02BB, 02FA, 06GA, 06SA).

SNU1NN

SNU1NN is a Group 1 unidirectional motor available in a limited displacements range from 2.6 up to 7.8 cm³/rev [from 0.158 up to 0.464 in³/rev]. The SNU1NN

motor construction is derived from the correspondent pump SNP1NN. Configurations include European flange and shaft (Code 01BA).

Group 1 Gear motors

SNU1NN 01BA (cut-away)

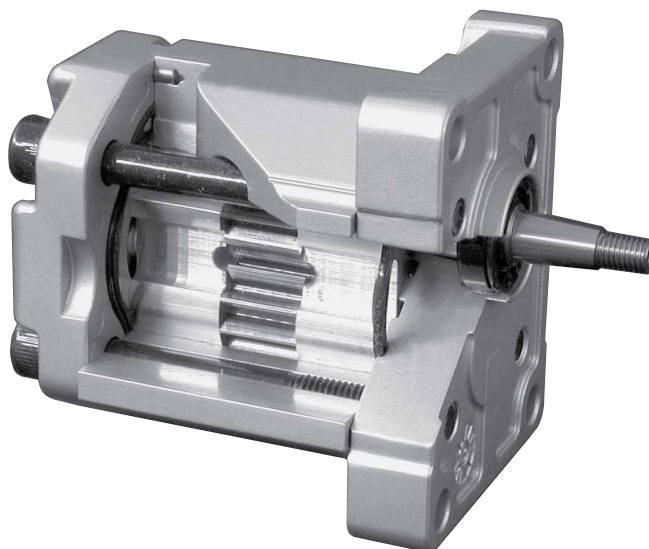

Technical data

		Frame size							
		2,6	3,2	3,8	4,3	6,0	7,8	010	012
Displacement	cm ³ /rev [in ³ /rev]	2.62 [0.158]	3.14 [0.195]	3.66 [0.231]	4.19 [0.262]	5.89 [0.366]	7.59 [0.463]	9.94 [0.607]	12 [0.732]
SKM1NN (a standard, bidirectional motor)									
Peak pressure	bar [psi]	270 [3915]	270 [3915]	270 [3915]	270 [3915]	250 [3625]	220 [3190]	180 [2610]	150 [2175]
Rated pressure		250 [3625]	250 [3625]	250 [3625]	250 [3625]	230 [3335]	200 [2900]	160 [2320]	130 [1895]
Back pressure		250 [3625]	250 [3625]	250 [3625]	250 [3625]	230 [3335]	200 [2900]	160 [2320]	130 [1895]
Minimum speed	min ⁻¹ (rpm)	1000	1000	1000	800	800	800	800	800
Maximum speed		4000	4000	3000	3000	2000	2000	2000	2000
SKU1NN (a standard, unidirectional motor)									
Peak pressure	bar [psi]	270 [3915]	270 [3915]	270 [3915]	270 [3915]	250 [3625]	220 [3190]	170 [2465]	140 [2030]
Rated pressure		250 [3625]	250 [3625]	250 [3625]	250 [3625]	230 [3335]	200 [2900]	150 [2175]	120 [1740]
Minimum speed	min ⁻¹ (rpm)	1000	1000	1000	800	800	800	800	800
Maximum speed		4000	4000	3000	3000	2000	2000	2000	2000
SNU1NN (a standard, unidirectional motor)									
Peak pressure	bar [psi]	270 [3915]	270 [3915]	270 [3915]	270 [3915]	190 [2755]	180 [2610]	-	
Rated pressure		250 [3625]	250 [3625]	250 [3625]	250 [3625]	170 [2465]	160 [2320]		
Minimum speed	min ⁻¹ (rpm)	1000	1000	1000	800	800	800		
Maximum speed		4000	4000	3000	3000	2000	2000		
All									

Group 1 Gear motors

		Frame size							
		2,6	3,2	3,8	4,3	6,0	7,8	010	012
Weight	kg [lb]	1.02 [2.26]	1.14 [2.51]	1.18 [2.60]	1.20 [2.65]	1.30 [2.87]	1.39 [3.06]	1.55 [3.42]	1.65 [3.64]
Moment of inertia of rotating components	x 10 ⁻⁶ kg·m ² [x 10 ⁻⁶ lbf·ft ²]	5.1 [121.0]	5.7 [135.2]	6.4 [151.9]	7.1 [168.5]	9.3 [220.7]	11.4 [270.5]	14.6 [339.4]	17.1 [405.8]

1 kg·m² = 23.68 lb·ft²

! Caution

The rated and peak pressure mentioned are for motors with flanged ports only. When threaded ports are required a derated performance has to be considered. To verify the compliance of an high pressure application with a threaded ports pump apply to a Danfoss representative.

Model code

A Family

A						B	C	D	E	F	G	H	I	J	K	L		M	N	O	
•	•	•	•	•	•												/				

SNU1NN	Unidirectional gear motor
SKU1NN	High torque unidirectional gear motor
SKM1NN	Standard bidirectional gear motor
SKM1IN	Bidirectional motor with relief valve

B Displacement

A						B	C	D	E	F	G	H	I	J	K	L		M	N	O	
						•	•	•									/				

2,6	2.62 cc
3,2	3.14 cc
3,8	3.66 cc
4,3	4.19 cc
5,5	5.23 cc
6,0	5.89 cc
7,8	7.59 cc
010	9.94 cc
012	12.0 cc

C Rotation

A						B	C	D	E	F	G	H	I	J	K	L		M	N	O	
							•										/				

Group 1 Gear motors

L	Left hand
R	Right hand
B	Bidirectional

D Project version (value representing a change to the initial project)

A	B	C	D	E	F	G	H	I	J	K	L	M	N	O
			•								/			

N	Std Version of Project
----------	------------------------

E Mounting flange

A	B	C	D	E	F	G	H	I	J	K	L	M	N	O
				•	•						/			

01	European 4 bolt flange with pilot Ø25,4 mm
02	European 4 bolt flange with pilot Ø30 mm
06	SAE A-A 2 bolt flange with pilot Ø50,8 mm

F Drive Gear

A	B	C	D	E	F	G	H	I	J	K	L	M	N	O
					•	•					/			

BA	Taper 1:8-M7-Key2,41 SKP1
BB	Taper 1:8-M10x1-Key 3
DB	Splined Z15-m0,75-alfa 30°-L14-Dr60,5
FA	Parallel Ø12-Thread M10x1-Key 3
GA	Parallel Ø12,7-Key 3,2
SA	SAE spline J498-9T-20/40 Flat Root Side FIT-L15

G Rear cover

A	B	C	D	E	F	G	H	I	J	K	L	M	N	O
						•	•				/			

P1	Standard cover for unidirectional motors
M1	Standard cover for motors drain M12x1,5
M2	Cover with drain 1/8" Gas
M3	Cover with drain 1/4" Gas
M6	Cover with drain 7/16-20UNF-2B
MH	Cover with drain M12x1,5 ISO6149
I1	Cover for unidirectional motors with relief valve
L6	Cover motor with side drain in vertical axis 7/16-20UNF-2B
V1	Cover for bidirectional motors with relief valve with drain 1/4 Gas

Group 1 Gear motors

H Inlet size; I Outlet size

A				B	C	D	E	F	G	H	I	J	K	L	M	N	O	
										•	•	•	•		/			

B1	8x30xM6	
B2	13x30xM6	
C1	8x26xM5	
C2	12x26xM5	
C3	13,5x30xM6	
D3	M14x1,5	
D5	M18x1,5	
D7	M22x1,5	

E3	9/16-18UNF	
E4	3/4-16UNF	
E5	7/8-14UNF	
F2	1/4 GAS	
F3	3/8 GAS	
F4	1/2 GAS	
H2	10xM12x1,5-ISO6149	
H4	12xM16x1,5-ISO6149	
H5	12xM18x1,5-ISO6149	
H7	13,5xM22x1, 5-ISO6149	

J Ports Pos & Spec Body

A				B	C	D	E	F	G	H	I	J	K	L	M	N	O	
												•	•		/			

N	Std from catalog
----------	------------------

Group 1 Gear motors

K Seals

A			B			C	D	E	F	G	H	I	J	K	L	M			N	O	
															•	/					

N	Standard NBR seal
H	VITONseals + special backing ring - special for SKU1NN

L Screws

A			B			C	D	E	F	G	H	I	J	K	L	M			N	O	
															•	/					

N	Std screws
B	GEOMET screws

M Set valves

A			B			C	D	E	F	G	H	I	J	K	L	M			N	O
															/	•	•	•		

NNN	No valve
V*	Integral relief valve pressure setting

* For details, see [Variant codes for ordering intergral relief valve](#) on page 24.

N Type of mark

A			B			C	D	E	F	G	H	I	J	K	L	M			N	O
															/				•	

N	Standard Danfoss Marking
A	Standard Danfoss Marking+Customer Code-Special
Z	Without Marking

O Mark position

A			B			C	D	E	F	G	H	I	J	K	L	M			N	O
															/					•

N	Std Marking position (on top)
A	Special Marking position on the bottom

Motor performance graphs

The following graphs provide typical inlet flow and output power for Group 1 motors at various working pressures. Data were taken using ISO VG46 petroleum /mineral based fluid at 50 °C [122 °F] (viscosity = 28 mm²/s [132 SUS]).

Group 1 Gear motors

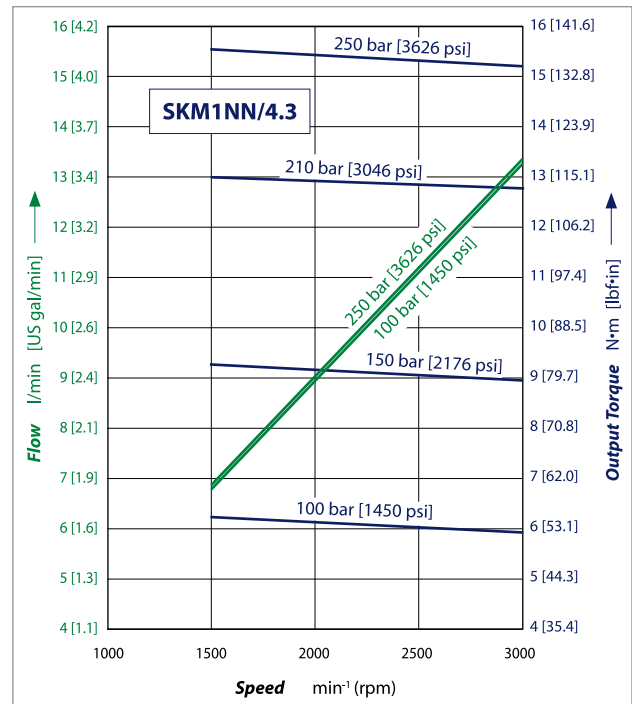
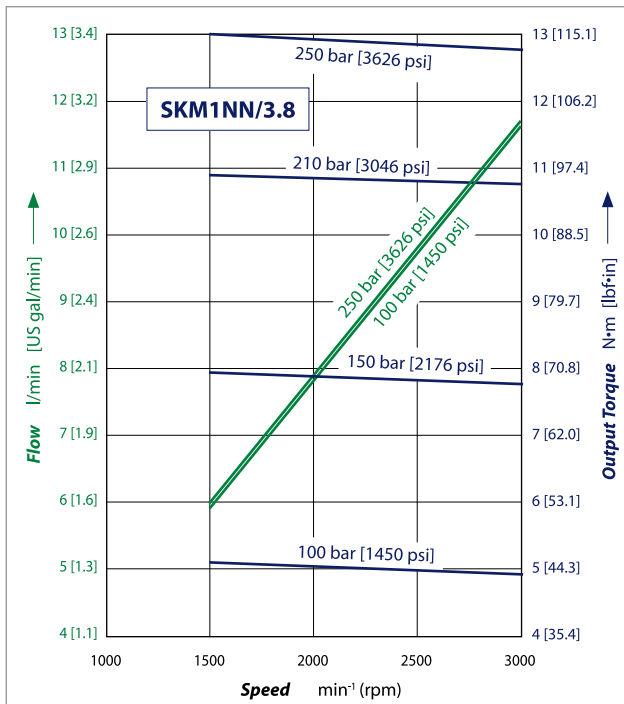
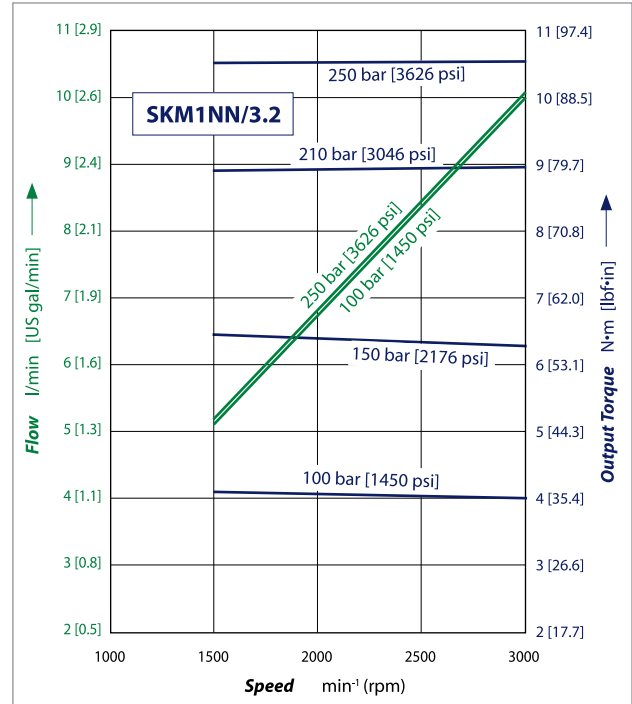
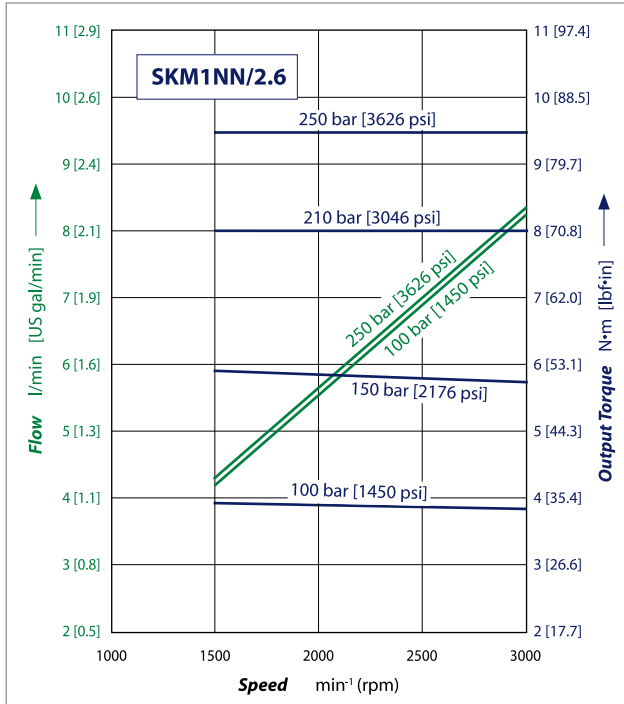

Group 1 Gear motors

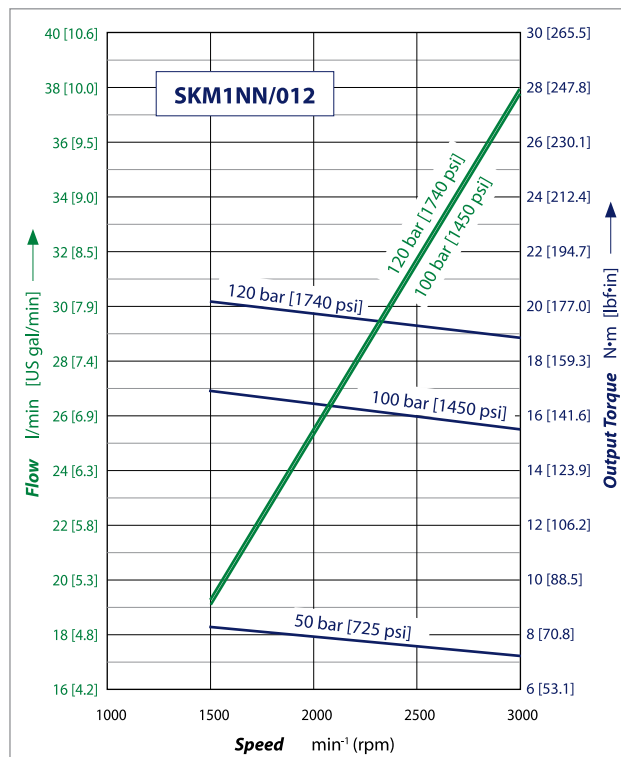
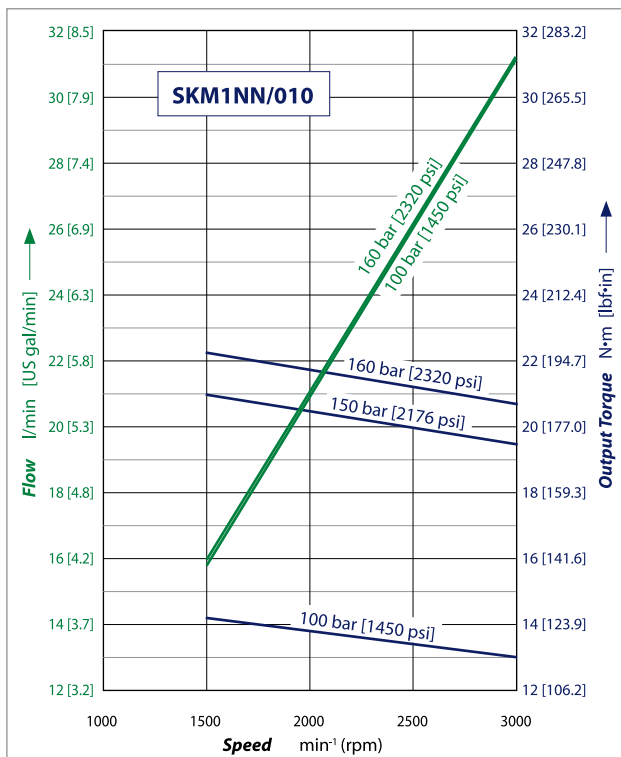
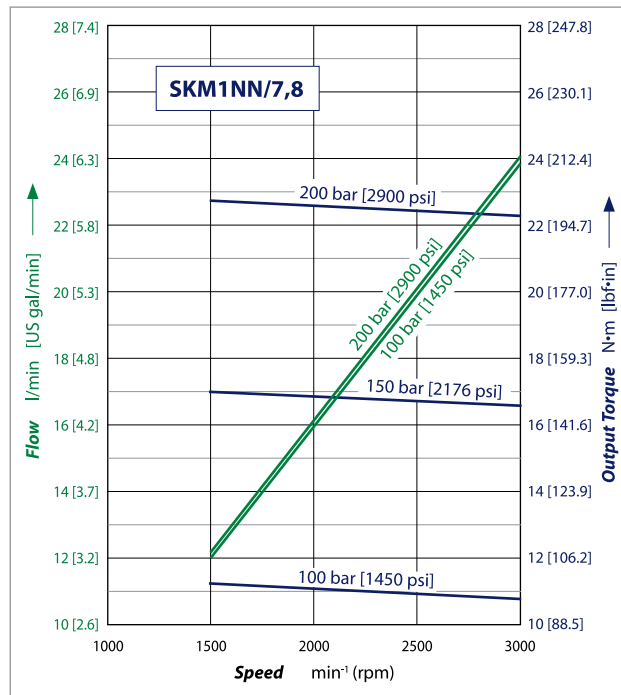
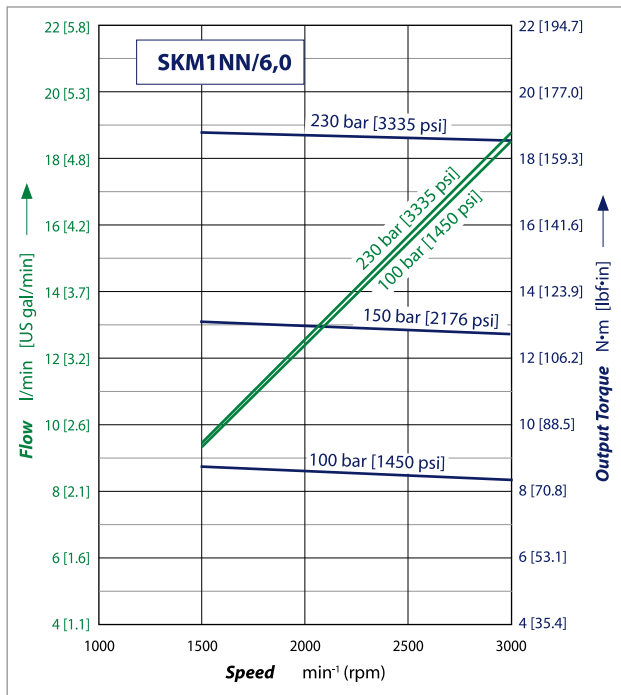

Group 1 Gear motors

Flange, shaft and port configurations

...For SKM1NN

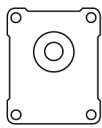
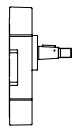
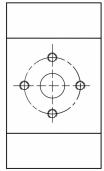
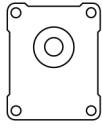
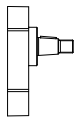
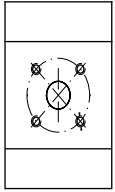
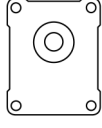
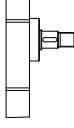
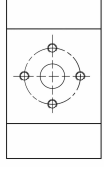
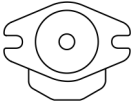
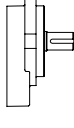
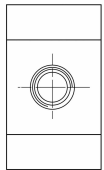
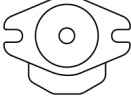
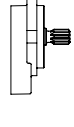
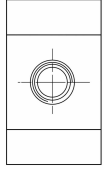
Code	Flange	Shaft	Port
01BA	European 01, 4-bolts pilot Ø 25.4 mm [1.0 in] 	Taper 1:8 	European in + pattern 
02BB	European 02, 4-bolts pilot Ø 30 mm [1.181] 	Taper 1:8 	German standard in X pattern 
02FA	European 02, 4-bolts pilot Ø 30 mm [1.181] 	Parallel 12 mm [0.472 in] 	European in + pattern 
06GA	SAE A-A 2-bolts 	Parallel 12.7 mm [0.5 in] 	Threaded SAE O-ring boss 
06SA	SAE A-A 2-bolts 	SAE A-A 9-teeth splined 	Threaded SAE O-ring boss 

...For SNU1NN

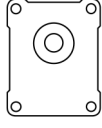
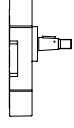
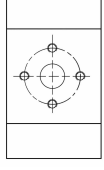
Code	Flange	Shaft	Port
01BA	European 01, 4-bolts pilot Ø 25.4 mm [1.0 in] 	Taper 1:8 	European in + pattern 

Group 1 Gear motors

Shaft options

Group 1 motors are available with a variety of splined, parallel, and tapered shaft ends. Not all shaft styles are available with all flange styles.

A	B	C	D	E	F	G	H	I	J	K	L	M	N	O
					•	•						/		

Shaft		Mounting flange code with maximum torque		
Code	Description	01	02	06
BA	Taper 1:8	25 [221]	-	-
BB	Taper 1:8	-	50 [442]	-
DB	Splined Z15-m0,75-alfa 30°-L14	-	35 [309]	-
FA	Parallel 12 mm [0.47 in]	-	24 [212]	-
GA	Parallel 12.7 mm [0.50 in]	-	-	32 [283]
SA	SAE spline J 498-9T-20/40DP	-	-	34 [301]

Recommended mating splines for Group 1 splined output shafts should be in accordance with SAE J498 or DIN 5482. Danfoss external SAE splines are flat root side fit with circular tooth thickness reduced by 0.127 mm [0.005 in] in respect to class 1 fit. The external DIN splines have an offset increased by 0.1 mm [0.004 in]. These dimensions are modified in order to assure a clearance fit with the mating spline.

[Other shaft options may exist. Contact your Danfoss representative for availability.](#)

! Caution

Shaft torque capability may limit allowable pressure. Torque ratings assume no external radial loading. Applied torque must not exceed these limits, regardless of stated pressure parameters. Maximum torque ratings are based on shaft torsional fatigue strength.

Integral relief valve - SKM1IN

Danfoss offers an optional integral relief valve integrated in the Group 1 motors rear cover. It is drained internally and directs all the flow from the motor inlet to the outlet when the inlet pressure reaches the valve setting.

The tables below show applicable variant codes for ordering motors with integral relief valve. Refer to [Model code](#) on page 16 for more information.

Valve schematic diagram

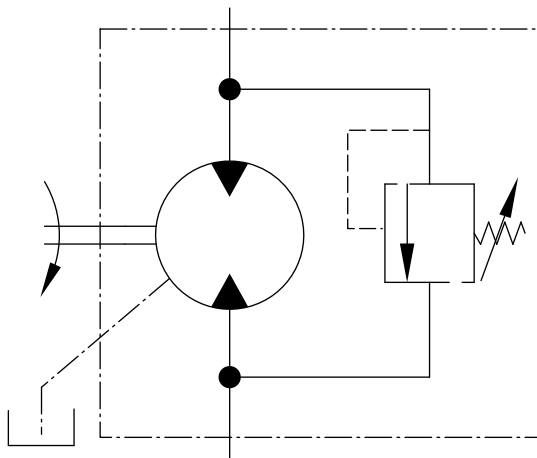

Group 1 Gear motors

Integral relief valve rear cover cross section

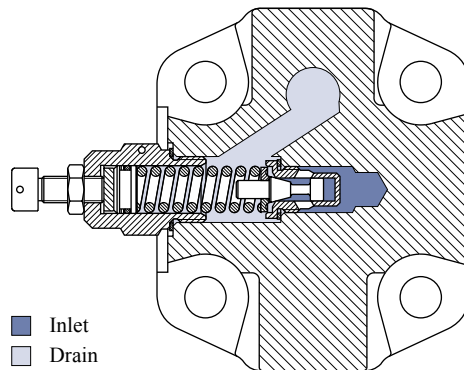

P101 016

Pressure vs flow

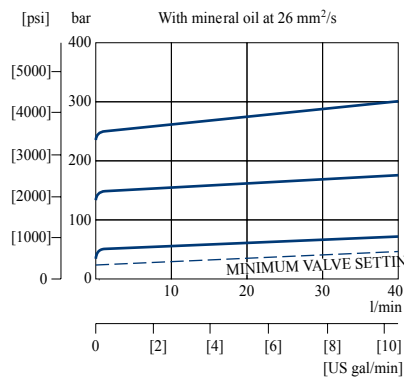

Variant codes for ordering intergral relief valve

Variant codes for ordering integral relief valve

A	B	C	D	E	F	G	H	I	J	K	L	/	M	N	O
													V	•	•

M Variant code (left part)

Code	Motor speed for RV setting min ⁻¹ (rpm)
A	not defined
C	500
E	1000
F	1250
G	1500
K	2000
I	2250
L	2500
M	2800

Group 1 Gear motors

M Variant code (left part) (continued)

Code	Motor speed for RV setting min ⁻¹ (rpm)
N	3000
O	3250

M Variant code (right part)

Code	Pressure setting bar [psi]
A	no setting
B	no valve
C	18 [261]
D	25 [363]
E	30 [435]
F	35 [508]
G	40 [580]
J	150 [2175]
K	50 [725]
L	60 [870]
M	70 [1015]
N	80 [1160]
O	90 [1305]
P	100 [1450]
Q	110 [1595]
R	120 [1740]
S	130 [1885]
T	140 [2030]
U	160 [2321]
V	170 [2466]
W	180 [2611]
X	210 [3046]
Z	250 [3626]

Group 1 Gear motors

Ports dimensions

Available ports for Group 1 motors

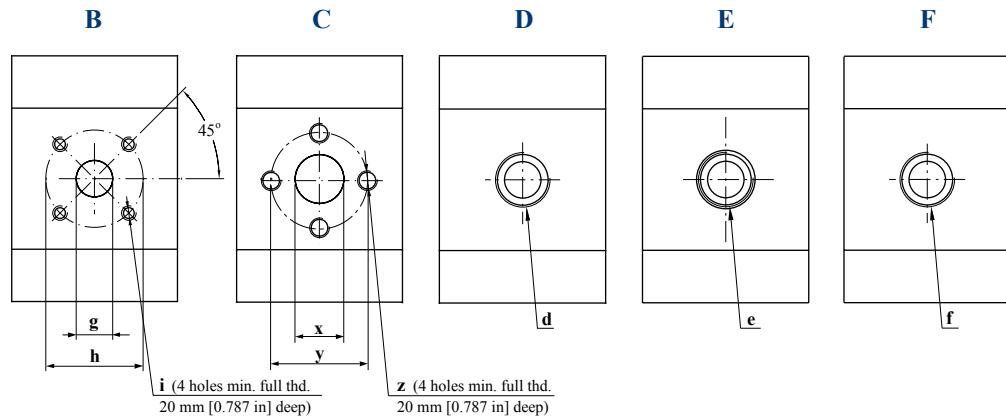

Bidirectional motor ports

SKM1NN bidirectional motor ports dimensions (all frame sizes)

Port type	B			C			D	E	F
Port dimensions	g	h	i	x	y	z	d	e	f
Inlet/Outlet	13 [0.512]	30 [1.181]	M6	12 [0.472]	26 [1.024]	M5	M18x1.5	¾-16UNF-2B	3/8 Gas (BSPP)
Drain	M12x1.5			M12x1.5			M12x1.5	7/16-20UNF-2B	1/8 Gas (BSPP)

Group 1 Gear motors

Unidirectional motor ports

SKM1NN bidirectional motor ports dimensions (all frame sizes)

Port type		B			C			D	E	F
Port dimensions		g	h	i	x	y	z	d	e	f
2.6	Inlet	8 [0.315]	30 [1.181]	M6	12 [0.472]	26 [1.024]	M5	M14x1 .5	9/16-18UNF- 2B	3/8 Gas (BSPP)
	Outlet	13 [0.512]						M18x1 .5	3/4-16UNF-2B	
3.2	Inlet	8 [0.315]						M14x1 .5	9/16-18UNF- 2B	
	Outlet	13 [0.512]						M18x1 .5	3/4-16UNF-2B	
3.8	Inlet	8 [0.315]						M14x1 .5	9/16-18UNF- 2B	
	Outlet	13 [0.512]						M18x1 .5	3/4-16UNF-2B	
4.3	Inlet	8 [0.315]						M14x1 .5	9/16-18UNF- 2B	
	Outlet	13 [0.512]						M18x1 .5	3/4-16UNF-2B	
6.0	Inlet	13 [0.512]						M18x1 .5	9/16-18UNF- 2B	
	Outlet	13 [0.512]						M18x1 .5	3/4-16UNF-2B	
7.8	Inlet	13 [0.512]						M18x1 .5	9/16-18UNF- 2B	
	Outlet	13 [0.512]						M18x1 .5	3/4-16UNF-2B	
010	Inlet	13 [0.512]	M18x1 .5	9/16-18UNF- 2B						
	Outlet	13 [0.512]	M18x1 .5	3/4-16UNF-2B						
012	Inlet	13 [0.512]	M18x1 .5	9/16-18UNF- 2B						
	Outlet	13 [0.512]	M18x1 .5	3/4-16UNF-2B						

Dimensions

Group 1 Gear motors

SKM1NN, SKU1NN, SNU1NN – 01BA

Standard porting drawing for 01BA

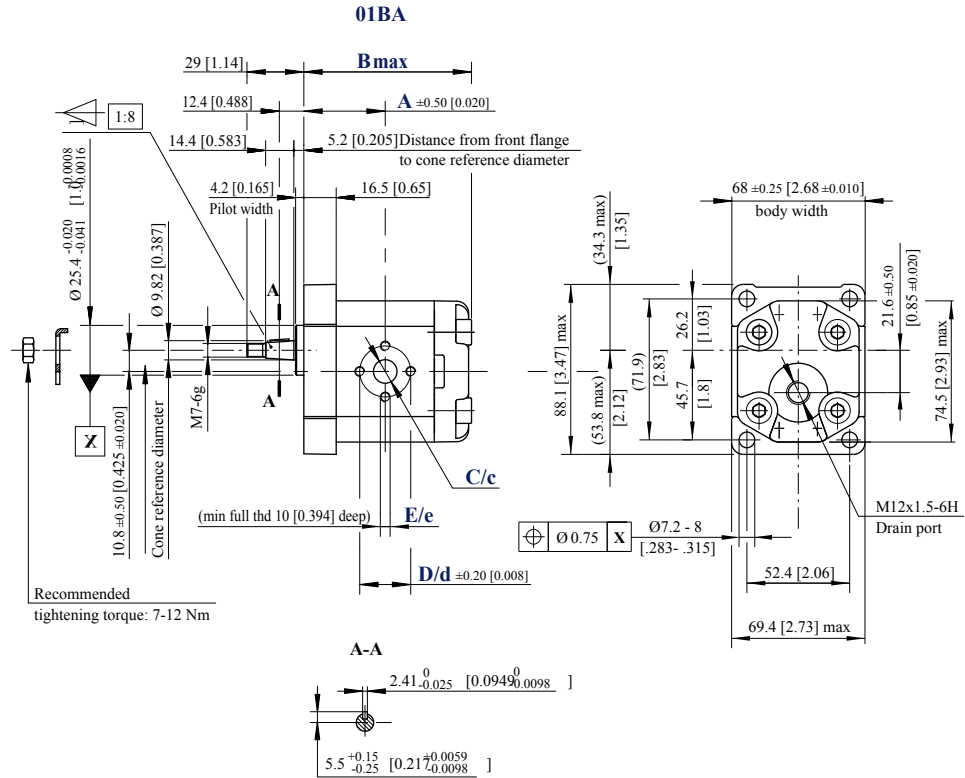

For unidirectional motors no case drain hole into the rear cover.

SKM1NN – 01BA dimensions

Type (displacement)		2.6	3.2	3.8	4.3	6.0	7.8	010	012
Dimension	A	40.5 [1.594]	41.5 [1.634]	42.5 [1.673]	43.5 [1.713]	46.75 [1.841]	50.0 [1.969]	54.5 [2.146]	58.5 [2.303]
	B	85.0 [3.346]	87.0 [3.425]	89.0 [3.504]	91.0 [3.583]	97.5 [3.839]	104.0 [4.094]	113.0 [4.449]	121.0 [4.764]
Inlet/Outlet	C/c	12 [0.472]							
	D/d	26 [1.024]							
	E/e	M5							

For unidirectional SNU1NN, SKU1NN dimensions see [Ports dimensions](#) on page 26.

Model code examples and maximum shaft torque

Flange/drive gear	Model code example	Maximum shaft torque
01BA	SKM1NN/3,2BN01BAM1C2C2NNNN/NNNNN SKU1NN/4,3LN01BAP1C2C2NNNN/NNNNN SNU1NN/3,8RN01BAP1F3F3NNNN/NNNNN	25 N·m [221 lb·in]

For further details on ordering, see [Model code](#) on page 16.

Group 1 Gear motors

SKM1NN, SKU1NN – 02BB, 02FA

Standard porting drawing for 02BB, 02FA

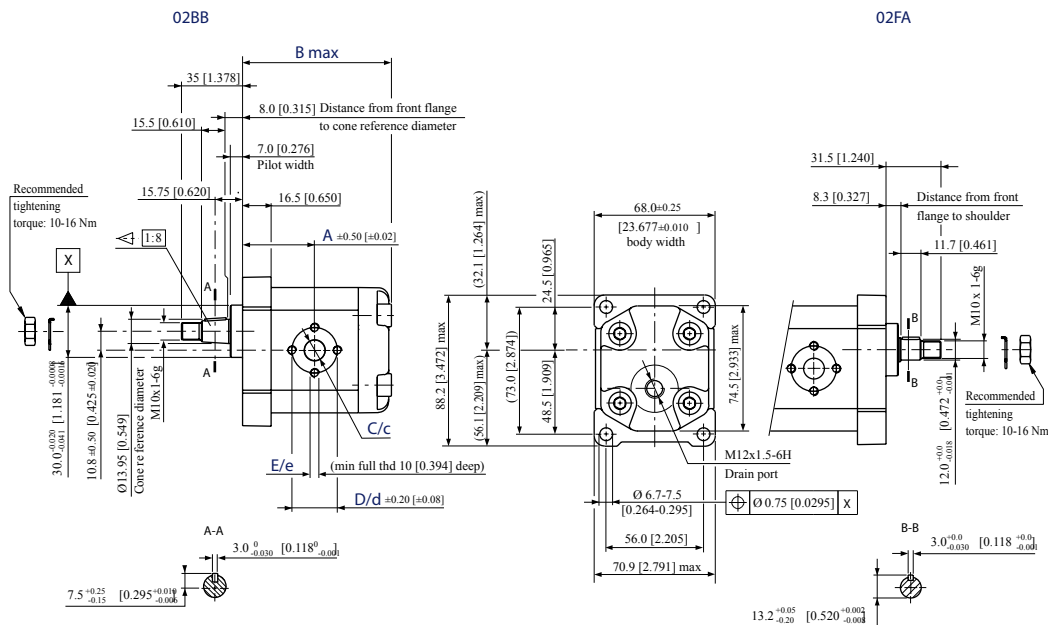

For unidirectional motors no case drain hole into the rear cover.

SKM1NN – 02BB and 02FA dimensions

Type (displacement)		2.6	3.2	3.8	4.3	6.0	7.8	010	012
Dimension	A	40.5 [1.594]	41.5 [1.634]	42.5 [1.673]	43.5 [1.713]	46.75 [1.841]	50.0 [1.969]	54.5 [2.146]	58.5 [2.303]
	B	85.0 [3.346]	87.0 [3.425]	89.0 [3.504]	91.0 [3.583]	97.5 [3.839]	104.0 [4.094]	113.0 [4.449]	121.0 [4.764]
Inlet/Outlet	C/c	12 [0.472]							
	D/d	26 [1.024]							
	E/e	M5							

For unidirectional SKU1NN dimensions see [Ports dimensions](#) on page 26.

Model code examples and maximum shaft torque

Flange/drive gear	Model code example	Maximum shaft torque
02BB	SKM1NN/010BN02BBM1C2C2NNNN/NNNNN SKU1NN/6,0LN02BBM1C2C2NNNN/NNNNN	50 N·m [442 lb·in]
02FA	SKM1NN/6,0BN02FAM1C2C2NNNN/NNNNN SKU1NN/6,0LN02FAM1C2C2NNNN/NNNNN	24 N·m [212 lb·in]

For further details on ordering, see [Model code](#) on page 16.

Group 1 Gear motors

SKM1NN, SKU1NN – 06GA and 06SA

Standard porting drawing for 06GA and 06SA

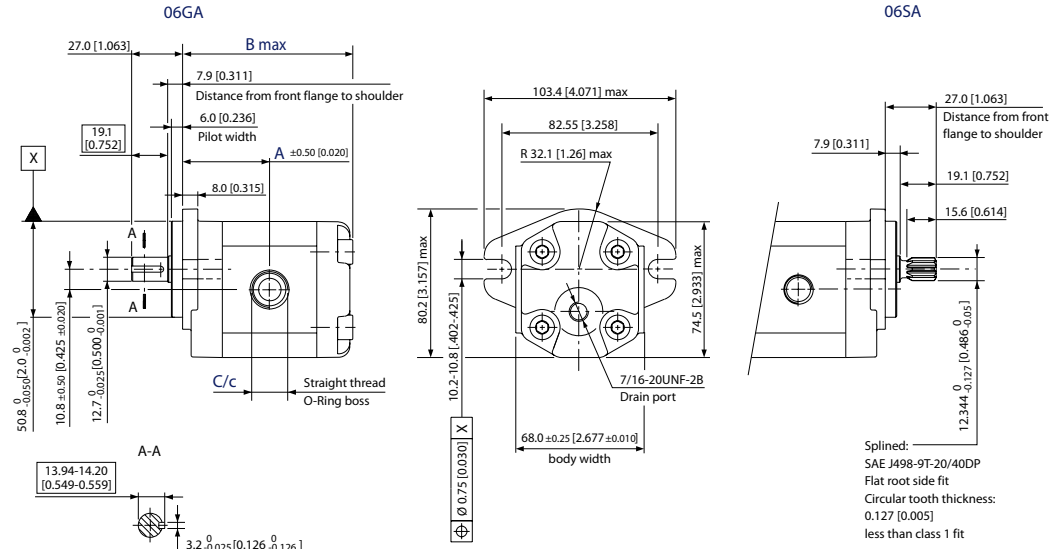

For unidirectional motors no case drain hole into the rear cover.

SKM1NN – 06GA and 06SA dimensions

Type (displacement)		2.6	3.2	3.8	4.3	6.0	7.8	010	012
Dimension	A	45 [1.771]	46 [1.811]	47 [1.850]	48 [1.889]	51.25 [2.017]	54.5 [2.145]	59 [2.322]	63.5 [2.500]
	B	89.5 [3.523]	91.5 [3.602]	93.5 [3.681]	95.5 [3.759]	102 [3.839]	108.5 [4.015]	117.5 [4.625]	125.5 [4.940]
Inlet/Outlet	C/c	¾-16UNF-2B, THD 14.3 [0.563] deep							

For unidirectional SKU1NN dimensions see [Ports dimensions](#) on page 26.

Model code examples and maximum shaft torque

Flange/drive gear	Model code example	Maximum shaft torque
06GA	SKM1NN/6,0BN06GAM6E4E4NNNN/NNNNN SKU1NN/4,3RN06GAP1E3E4NNNN/NNNNN	32 N•m [283 lb•in]
06SA	SKM1NN/012BN06SAM6E4E4NNNN/NNNNN SKU1NN/3,2LN06SAP1E3E4NNNN/NNNNN	34 N•m [301 lb•in]

For further details on ordering, see [Model code](#) on page 16.

Group 2 Gear motors

Motor design

SNM2NN

SNM2NN is the group 2 bidirectional motor available in the whole displacements range from 6 up to 25 cm^3/rev [from 0.37 up to 1.538 in^3/rev].

Configurations include European and SAE flanges and shafts (Code 01BA, 01FA, 01DA, 02AA, 02DB, 03CA, 04AA/05AA, 04DB/05DB, 06GA, 06SA).

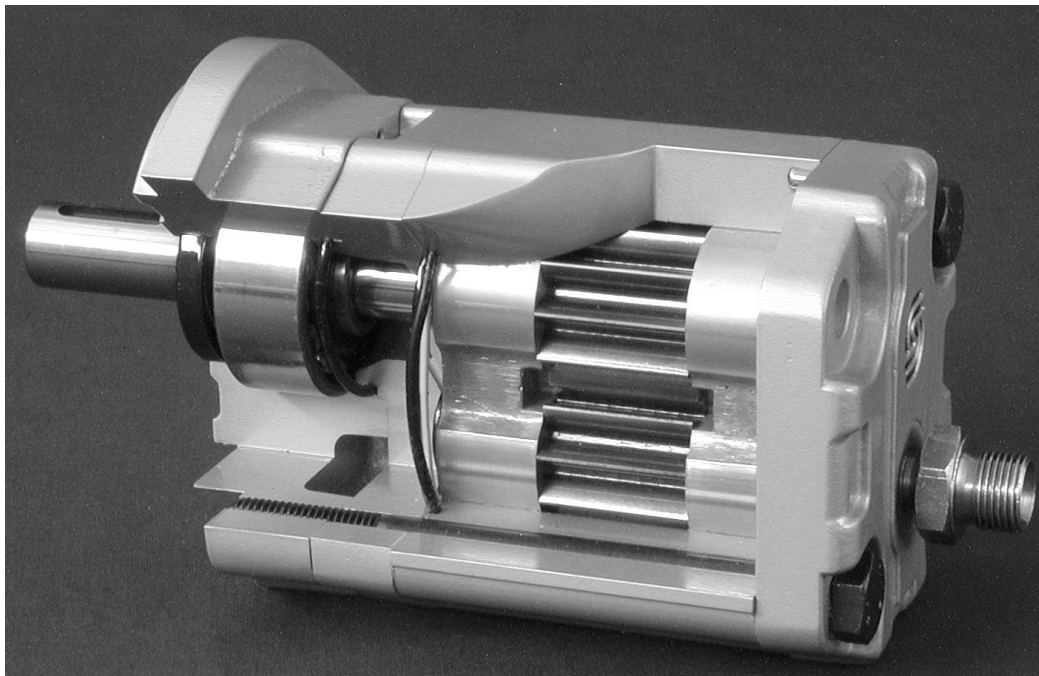

SNU2NN

SNU2NN is the group 2 unidirectional motor available in the displacements range from 8 up to 25 cm^3/rev [from 0.513 up to 1.538 in^3/rev]. The SNU2NN motor construction is derived from the correspondent pump SNP2NN.

Configurations include European and SAE flanges and shafts (Code 01BA, 01FA, 01DA, SNU2NN 06SA (cut away) 02AA, 02DB, 03CA, 04AA/05AA, 04DB/05DB, 06GA, 06SA).

Group 2 Gear motors



SKU2NN

SKU2NN is the Group 2 unidirectional motor available in the displacements range from 8 up to 25 cm³/rev [from 0.513 up to 1.538 in³/rev]. The SKU2NN motor construction is derived from the correspondent pump SKP2NN. Configuration includes SAE flange and shaft only (Code 06SA).

Technical data

The table below details the technical data for Group 2 gear motors based on the model and displacement configuration.

Technical data for Group 2 gear motors

	Frame size	6.0*	8.0	011	014	017	019	022	025
		cm ³ /rev [in ³ /rev]							
Displacement	cm ³ /rev [in ³ /rev]	6.0 [0.36]	8.4 [0.513]	10.8 [0.659]	14.4 [0.879]	16.8 [1.025]	19.2 [1.171]	22.8 [1.391]	25.2 [1.538]
SNM2NN (bidirectional motor)									
Peak pressure	bar [psi]	280 [4060]	280 [4060]	280 [4060]	280 [4060]	260 [3770]	230 [3335]	200 [2900]	180 [2610]
Rated pressure		250 [3625]	250 [3625]	250 [3625]	250 [3625]	230 [3335]	210 [3045]	180 [2610]	160 [2320]
Outlet back pressure		250 [3625]	250 [3625]	250 [3625]	250 [3625]	230 [3335]	210 [3045]	180 [2610]	160 [2320]

Group 2 Gear motors

Technical data for Group 2 gear motors (continued)

	Frame size								
		6.0*	8.0	011	014	017	019	022	025
Minimum speed	min ⁻¹ (rpm)	700	700	700	700	500	500	500	500
Maximum speed		4000	4000	4000	4000	4000	3500	3500	3500
SNU2NN (unidirectional motor)									
Peak pressure	bar [psi]	-	280 [4060]	280 [4060]	280 [4060]	260 [3770]	230 [3335]	200 [2900]	180 [2610]
Rated pressure			250 [3625]	250 [3625]	250 [3625]	230 [3335]	210 [3045]	180 [2610]	160 [2320]
Minimum speed	min ⁻¹ (rpm)		600	600	600	500	500	500	500
Maximum speed			3500	3500	3500	3000	3000	3000	2500
SKU2NN (unidirectional motor)									
Peak pressure	bar [psi]	-	280 [4060]	280 [4060]	280 [4060]	260 [3770]	230 [3335]	200 [2900]	175 [2815]
Rated pressure			250 [3625]	250 [3625]	250 [3625]	230 [3335]	210 [3045]	180 [2610]	160 [2320]
Minimum speed	mi ⁻¹ (rpm)		600	600	600	500	500	500	500
Maximum speed			3500	3500	3500	3000	3000	3000	2500
All (SNM2NN, SNU2NN, SKU2NN)									
Weight	kg [lb]	2.4 [5.3]	2.5 [5.5]	2.7 [5.5]	2.9 [6.3]	3.0 [6.5]	3.1 [6.7]	3.2 [7.0]	3.3 [7.3]
Moment of inertia of rotating components	x 10 ⁻⁶ kg·m ² [x 10 ⁻⁶ lb·ft ²]	26.5 [629]	32.4 [769]	38.4 [911]	47.3 [1122]	53.3 [1265]	59.2 [1405]	68.1 [1616]	74.1 [1758]
Theoretical flow at maximum speed	l/min [US gal/min]	24 [6.3]	33.6 [8.9]	43.2 [11.4]	50.4 [13.3]	50.4 [13.3]	57.6 [15.2]	68.4 [18.0]	75.6 [20.0]

* Before choosing this frame size, please apply to Danfoss technical department.

1 kg·m² = 23.68 lb·ft²

! Caution

The rated and peak pressure mentioned are for motors with flanged ports only. When threaded ports are required a de-rated performance has to be considered. To verify the compliance of an high pressure application with a threaded ports pump apply to a Danfoss representative.

Model code

A Family

A	B	C	D	E	F	G	H	I	J	K	L	M	N	O
•	•	•	•	•	•	•	•	•	•	•	•	•	•	•

Group 2 Gear motors

SKU2NN	Big shaft GR2 Unidir.Motor
SNM2DN	Gr2 Bidir.Motor-Int.Drain
SNM2FL	Gr2 Bidir.Motor+Break.Valve-Vert.drain-Special
SNM2FN	Gr2 Bidir.Motor+Break.Valve-Special
SNM2GC	Gr2 Bidir.Motor+Anticav.Check Val.-Ax.drain
SNM2GL	Gr2 Bidir.Motor-Anticav.Check Val.-vert.drain
SNM2GN	Gr2 Bidir.Motor-Anticav.Check Valve
SNM2IL	Gr2 Bidir.Motor+Int.drain RV-Vert.drain
SNM2IN	Gr2 Bidir.Motor+Int.drain RV
SNM2JN	Gr2 Bid.Motor+Int.drain RV+Anticav.Check Valve
SNM2NC	Gr2 Bidir.Motor-Cover Ports-Ax.drain
SNM2NL	Gr2 Bidir.Motor-Vert.drain
SNM2NN	Gr2 Bidir.Motor
SNM2SN	Gr2Bidir.Motor+by-pass electric valve-Special
SNU2EN	Gr2 Unidir.Motor+Ext.drain RV
SNU2GN	Gr2 Unidir.Motor+Anticav.Check Valve
SNU2GC	Gr2 Unidir.Motor-In./Out. on Cover+Anticav.Check Valve
SNU2IN	Gr2 Unidir.Motor+Int.drain RV
SNU2JN	Gr2 Unidir.Motor+Int.drain RV+Anticav.Check Valve
SNU2NC	Gr2 Unidir.Motor-In.-Out.on cover
SNU2NN	Gr2 Unidir.Motor
SNU2QN	Gr2 Unid.Motor-Ext.drain RV+Anticav.Check Valve
SNU2TN	Gr2 Unidir.Motor-Break.Valve as Anticav.Valve-Special

B Displacement

A	B	C	D	E	F	G	H	I	J	K	L	M	N	O
	• • •											/		

6,0	6,0 cc -Special
8,0	8,4 cc
011	10,8 cc
014	14,4 cc
017	16,8 cc
019	19,2 cc
022	22,8 cc
025	25,2 cc

Group 2 Gear motors

C Rotation

A	B	C	D	E	F	G	H	I	J	K	L	M	N	O
		•									/			

L	Left hand
R	Right hand
B	Bidirectional

D Project version (value representing a change to the initial project)

A	B	C	D	E	F	G	H	I	J	K	L	M	N	O
			•								/			

N	Std Version of Project
4	Precharged seal on cover-Special heavy-duty applications
6	Short version - Special

E Mounting flange

A	B	C	D	E	F	G	H	I	J	K	L	M	N	O
				•	•						/			

01	pilot Ø36,5+4 holes
02	pilot Ø80+4 holes
03	pilot Ø52+O-ring+4 holes through body
04	pilot Ø50+2 holes through body
05	pilot Ø50+2 holes through body
06	SAE A pilot Ø82,55+2 holes
91	Outrigger Bearing Type 01+taper shaft 1:8-M12x1,25-Key4
92	Outrigger Bearing Type 02+taper shaft 1:5-M12x1,25-Key3
94	Outrigger Bearing Type 04+taper shaft 1:5-M12x1,25-Key3
9A	Outrigger Bearing Type 01+taper shaft 1:8-M12x1,25-Key3.2
9D	Outrigger Bearing Type 01+parallel shaft Ø15-Key4
9F	Outrigger Bearing Type 02+taper shaft 1:5-M14x1,5-Key4+special shaft seal RZB
9G	Outrigger Bearing Type 04+taper shaft 1:5-M12x1,25-Key3 + 4 M10 assembly thd holes "HELI-COIL- Special
9H	Outrigger Bearing Type 06+taper shaft 1:8-M12x1,25-Key4
9J	Outrigger Bearing Type 06 with parallel shaft Ø3/4 (Ø19.05 mm)
9L	Outrigger Bearing Type 01 parallel shaft Ø22 pilot Ø50,8
9M	Outrigger Bearing Type 01 parallel shaft Ø18 pilot Ø36,5

F Drive gear

A	B	C	D	E	F	G	H	I	J	K	L	M	N	O
					•	•					/			

Group 2 Gear motors

B1	Taper 1:8-M12x1,25-Key 4/6 lowered
BA	Taper 1:8-M12x1,25-Key 4
BB	Taper 1:8-M12x1,25-Key 4/3,2
CA	Tang 8x17,8xL6,5 FR03
DA	Spline DIN 5482 B17x14-L10
DB	Spline DIN 5482 B17x14-L14
FA	Parallel Ø15-L30+Key 4x25
GA	Parallel SAE Ø15,875-L23,8-Key 4x18
GB	Parallel SAE Ø15,875-L50,8-Key 4x40
SA	Spline SAE J498-9T-16/32
SB	Spline SAE J498-11T-16/32 -Special only for Version 2

G Rear cover

A	B	C	D	E	F	G	H	I	J	K	L	M	N	O
						•	•					/		

C7	Cover for unidirectional motors front SAE ports: Inlet 3/4-16UNF-2B; Outlet 3/4-16UNF-2B
E1	Cover for unidirectional motors with relief valve - external drain 3/8 Gas
E6	Cover for unidirectional motors with Relief Valve ext. drain 3/4-16UNF-2B
F1	Cover motor per braking valve and drain 1/4 Gas
F6	Cover motor per braking valve and drain 9/16-18UNF-2B
G1	Cover motor front ports: Inlet 1/2 G; Outlet 1/2 G; Drain 1/4 G
G6	Cover motor front ports: Inlet 7/8-14UNF; Outlet 7/8-14UNF; Drain 9/16-18UNF
I1	Cover for unidirectional motors with RV
J1	Cover motor per braking valve with drain in vertical axis 1/4 G
J6	Cover motor per braking valve with side drain in vertical axis 9/16-18UNF-2B
L1	Cover motor-drain in vertical axis 1/4 Gas
L3	Cover motor-drain in vertical axis 1/4 Gas for flange type 03
L6	Cover motor-drain in vertical axis 9/16-18UNF-2B
L7	Cover motor-drain at 22° left 7/16-20UNF-2B
L8	Cover motor-drain in horizontal axis 9/16-18UNF-2B drain left
LC	Cover motor-drain in horizontal axis 1/4 Gas right side
LD	Cover motor-drain in horizontal axis 1/4 Gas left side
LE	Cover motor-drain in horizontal axis M12x1,25 ISO 6149
LF	Cover motor-drain in horizontal axis M12x1,5 right side
LH	Cover motor-drain in horizontal axis 9/16-18UNF-2B drain right
LS	Cover motor-drain at 22° left 7/16-20UNF-2B drive gear side

Group 2 Gear motors

LT	Cover motor-drain in vertical axis 1/4 Gas for flange typo 03 drive gear side
LX	Cover motor-drain in vertical axis 9/16-18UNF-2B drive gear side
LZ	Cover motor-drain in vertical axis 1/4 Gas drive gear side
M1	Std cover motor drain 1/4 Gas driven side
M3	Std cover motor drain 1/4 Gas for flange typo 03
M4	Std cover motor drain 9/16-18UNF-2B for flange typo 03
M6	Std cover motor drain 9/16-18UNF-2B
M7	Std cover motor-drain 1/4 Gas drive side
M8	Special intermediate motor flange tipo 01-drain 1/4 Gas - Special
P1	Std cover for unidirectional motors
P3	Std cover for unidirectional motors for flange typo 03
S1	Cover motor-Electric-piloted distributor+by-pass-drain vert.1/4 G-In-Out 1/2 G - Special
T1	Cover motor per braking valve used as anti-cavitation valve internal drain - Special
V1	Cover motor per RV with drain 1/4 Gas
V2	Cover motor per RV with drain vertical axis 1/4 Gas driven side
V6	Cover motor per RV with drain 9/16-18UNF-2B
V7	Cover motor per RV with drain vertical axis 9/16-18UNF-2B driven side

H Inlet size; I Outlet size

NN	Without inlet	
B3	13,5x30xM6 in X	
B5	15x35xM6	
B6	15x40xM6	
B7	20x40xM6	
BB	27x55xM8	
C2	12x26xM5	
C3	13,5x30xM6	
C4	15x35xM6 DXK(+)	
C5	13,5x40xM8	
C6	20x40xM6 DXK(+)	
C7	20x40xM8	
C8	23,5x40xM8	
CS	13,5x30xM6 (2 holes)	
CV	20x40xM8 (2 holes at 30°)	
CX	20x40xM8 (2 holes)	
CY	20x40xM8 (3 holes)	

Group 2 Gear motors

D4	M16x1,5	
D5	M18x1,5	
D7	M22x1,5	
D9	M26x1,5	
E3	9/16-18UNF	
E4	3/4-16UNF	
E5	7/8-14UNF	
E6	1-1/16-12UN	
E8	1-5/16-12UN	

F3	3/8 GAS	
F4	1/2 GAS	
F5	3/4 GAS	
F6	1 GAS	
H5	M18x1,5-ISO6149	
H7	M22x1,5-ISO6149	
H8	M27x2-ISO6149	
H9	M33x2-ISO6149	
M1	12x17,48x38,1xM6	
M2	12x17,48x38,1xM8	
M3	18,5x17,48x38,1xM8	
M5	25/20x52,37x26,19xM10	
MB	12x38,1x17,48xM8(=)	
MC	18,5x47,63x22,23xM6(=)	
MD	18,5x47,63x22,23xM8(=)	
ME	18,5x47,63x22,23xM10(=)	
MG	25/20x52,37x26,19xM10(=)	
MH	31/25x58,72x30,18xM10(=)	

J Ports pos & Spec body

A	B	C	D	E	F	G	H	I	J	K	L	M	N	O
									•	•		/		

NN	Std from catalogue
YY	PortBx-Bx with flange SAE-A; off-set to rear cover
EU	Dist. from front flange=58,5 - Special
PL	Inletport Left position looking gear drive from front flange

Group 2 Gear motors

PR	Inletport Right position looking gear drive from front flange
ZZ	PortBx-Bx in the center of the body - Option

K Seals

A	B	C	D	E	F	G	H	I	J	K	L	M	N	O
											•	/		

N	Standard NBR seals
B	VITON seals (only for unidirectional motors)
D	D VITON shaft seal with dust lip (type BABSL)
F	VITON seals except for shaft seal - Special
X	NBR seals+Dust Cover
Y	VITON seals + Dust Cover
Z	VITON shaft seal + Dust Cover

L Screws

A	B	C	D	E	F	G	H	I	J	K	L	M	N	O
											•	/		

N	Std burnished screws
A	Zinc plated screws
B	Geomet screws

M Set valves

A	B	C	D	E	F	G	H	I	J	K	L	M	N	O
												/	•	•

NNN	No valve
V*	not defined-pressure no setting :oil ISO VG68-45°

* For details, see [Variant codes for ordering integral relief valve](#) on page 24.

N Type of mark

A	B	C	D	E	F	G	H	I	J	K	L	M	N	O
												/		•

N	Standard Danfoss Marking
A	Standard Danfoss Marking+Customer Code-Special
Z	Without Marking

O Mark position

A	B	C	D	E	F	G	H	I	J	K	L	M	N	O
												/		•

Group 2 Gear motors

N	Std Marking position (on top)
A	Special Marking position on the bottom

Group 2 Gear motors

Motor performance graphs

The graphs on the next few pages provide typical output flow and input power for Group 2 motors at various working pressures. Data were taken using ISO VG46 petroleum /mineral based fluid at 50 °C [122 °F] (viscosity = 28 mm²/s [132 SUS]).

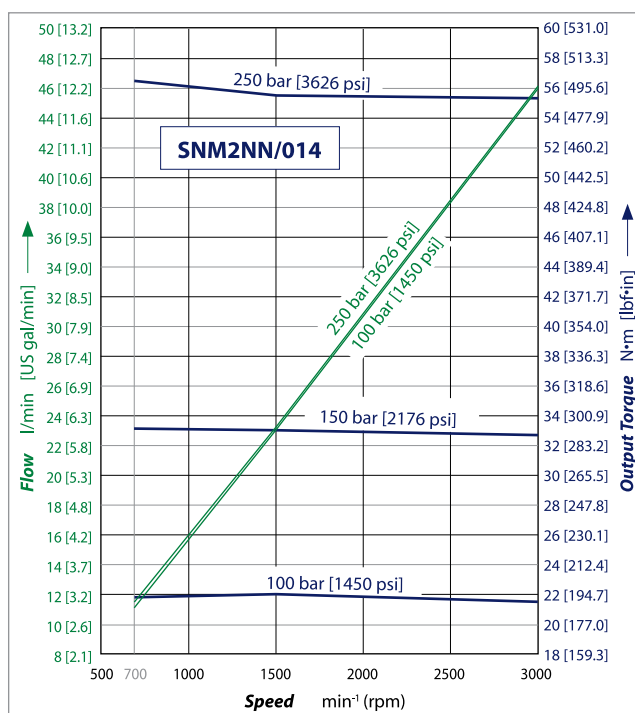
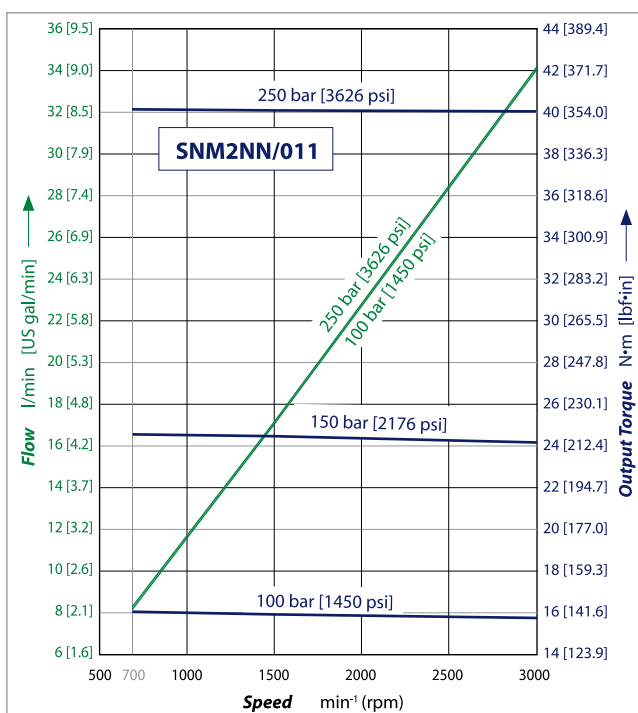
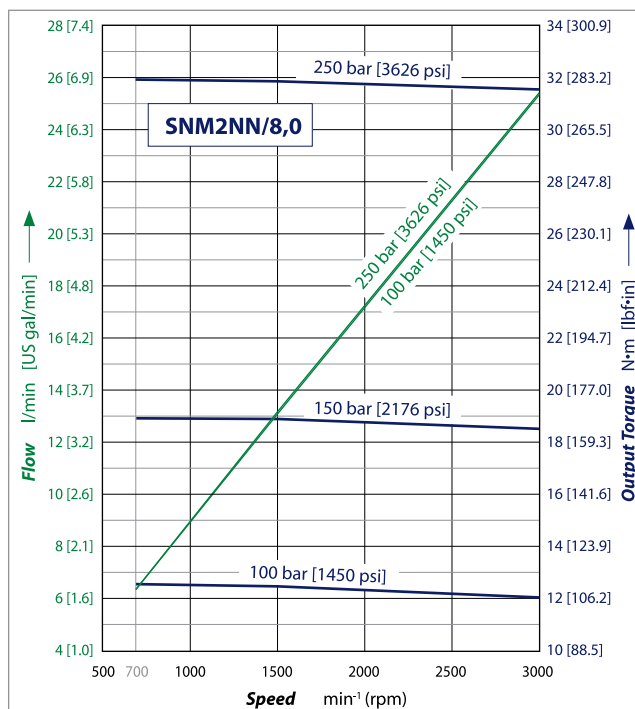
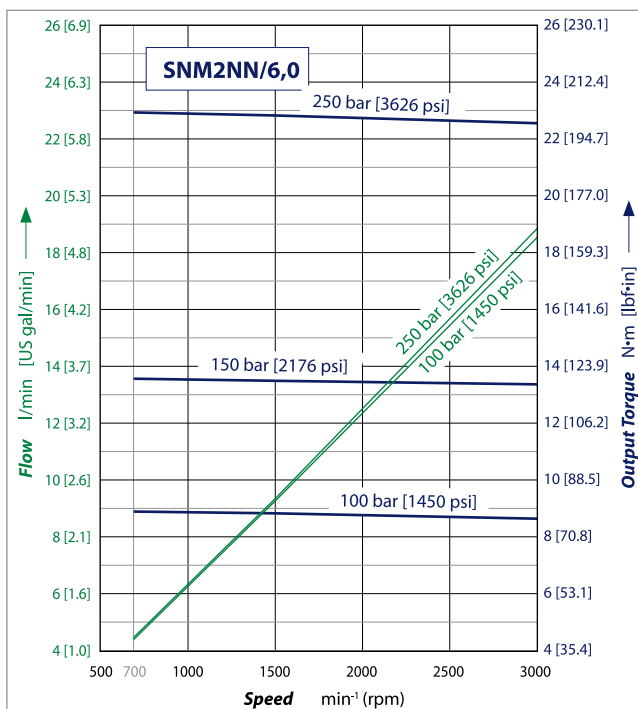

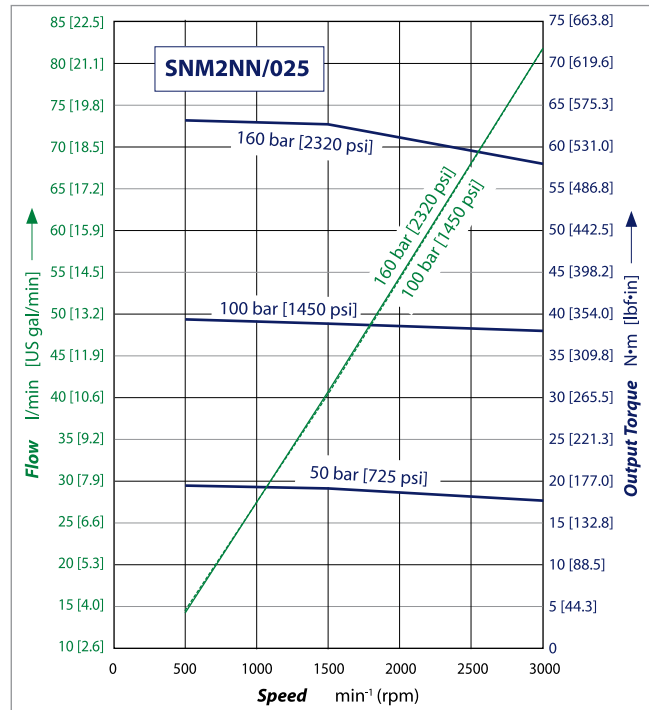
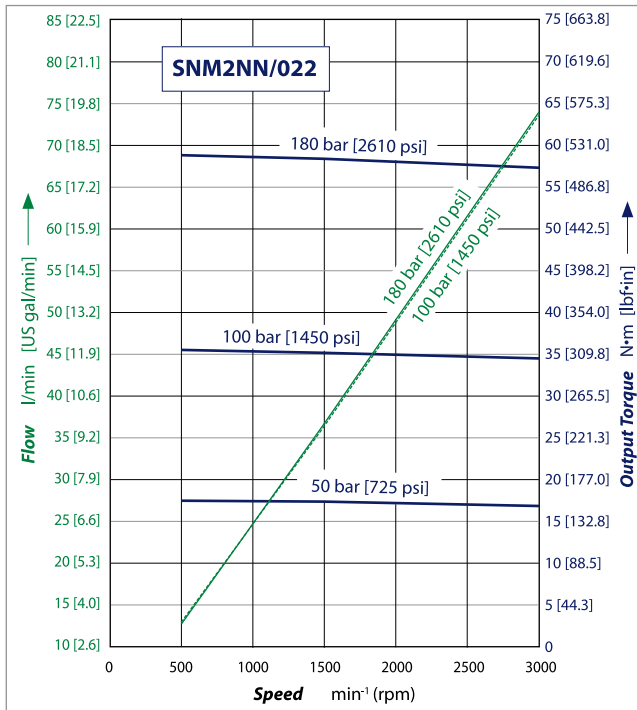
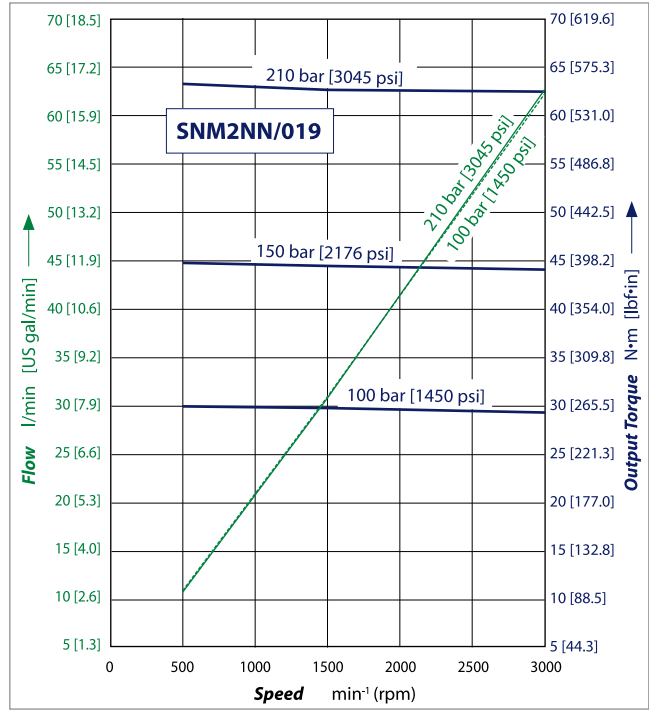
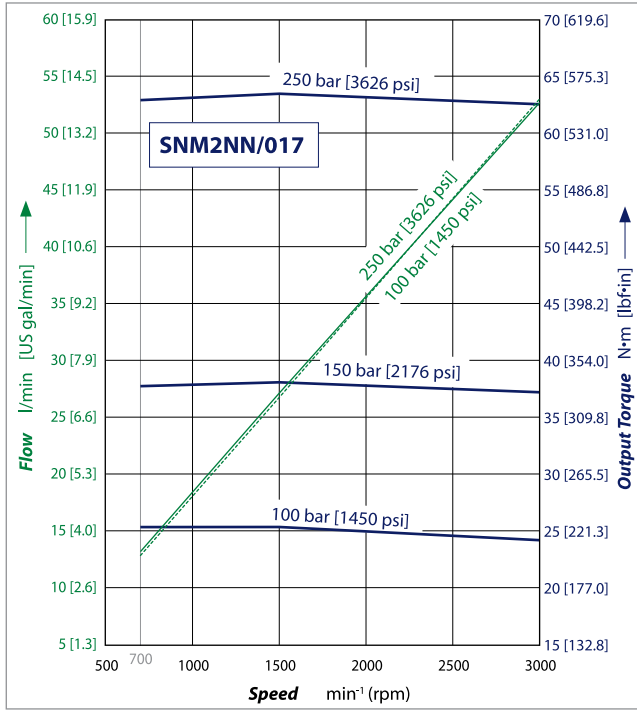

Group 2 Gear motors



Group 2 Gear motors



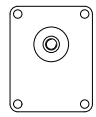
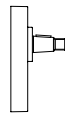
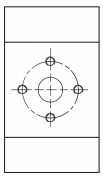
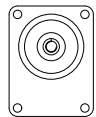
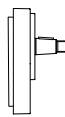
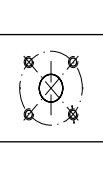

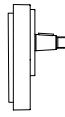
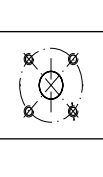
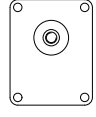
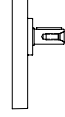
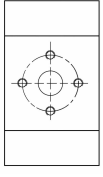
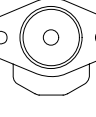
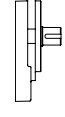
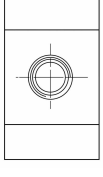
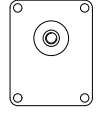
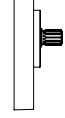
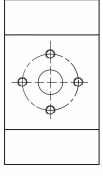
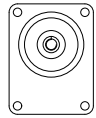
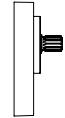
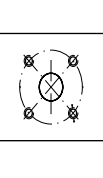
Flange, shaft and port configurations

... For SNM2NN and SNU2NN

Code	Flange	Shaft	Port
01BA	European 01, 4-bolts pilot Ø 36.5 mm [1.44 in] 	1:8 tapered 	European in + pattern 
02AA	European 02, 4-bolts pilot Ø 80 mm [3.15 in] 	1:5 tapered 	German standard in X pattern 
04AA/ 05AA	German PTO 2-bolts pilot Ø 50 mm [1.97 in] 	1:5 tapered 	German standard in X pattern 
01FA	European 01, 4-bolts pilot Ø 36.5 mm [1.44 in] 	Ø 15 mm [0.59 in] parallel 	European in + pattern 
06GA	SAE A pilot Ø 82.55 mm [3.25 in] 	Ø 15.7 mm [0.625 in] parallel 	Threaded SAE O-ring boss port 
01DA	European 01, 4-bolts pilot Ø 36.5 mm [1.44 in] 	9-teeth splined m = 1.60, α = 30° DIN 5482-B17x14 	European in + pattern 
02DB	European 02, 4-bolts pilot Ø 80 mm [3.15 in] 	9-teeth splined m = 1.60, α = 30° DIN 5482-B17x14 	German standard in X pattern 

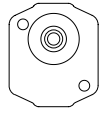
Group 2 Gear motors

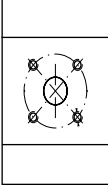
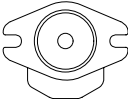
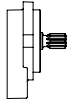
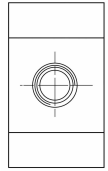
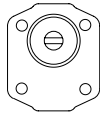
... For SNM2NN and SNU2NN (continued)

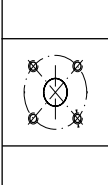
Code	Flange		Shaft		Port	
04DB/ 05DB	German PTO 2-bolts pilot Ø 50 mm [1.97 in]		9-teeth splined $m = 1.60, \alpha = 30^\circ$ DIN 5482-B17x14		German standard in X pattern	
06SA	SAE A pilot Ø 82.55 mm [3.25 in]		SAE 9-teeth splined		Threaded SAE O-ring boss port	
03CA	tang pilot Ø 52 mm [2.066 in]		Turolla standard tang		German standard in X pattern	

Shaft options

Group 2 motors are available with a variety of splined, parallel, and tapered shaft ends. Not all shaft styles are available with all flange styles.

Valid combinations and nominal torque ratings are shown in the following table. Torque ratings assume no external radial loading. Applied torque must not exceed these limits regardless of pressure parameters stated earlier. Maximum torque ratings are based on shaft torsional fatigue strength.

Shaft availability and nominal torque capability

A	B	C	D	E	F	G	H	I	J	K	L	M	N	O
					•	•						/		

Shaft		Mounting flange code with maximum torque in N·m [lb·in]						
Code	Description	01	02	B2	03	04	05	06
AA	Taper 1:5-M12x1,25-Key 3		140 [1239]	140 [1239]		140 [1239]	140 [1239]	
AD	Taper 1:5-M12x1,25-Key 3-Drive (Version 6 only)		140 [1239]				140 [1239]	
B1	Taper 1:8-M12x1,25-Key 4/6 lowered	150 [1328]						
BA	Taper 1:8-M12x1,25-Key 4	150 [1328]				150 [1328]	150 [1328]	150 [1328]
BB	Taper 1:8-M12x1,25-Key 4/3,2	150 [1328]						150 [1328]
BJ	Taper 1:8-M12x1,25-Key 4/3 black steel						150 [1328]	
CA	Tang 8x17,8xL6,5 FR03					70 [620]		
DA	Spline DIN 5482 B17x14-L10	90 [797]						

Group 2 Gear motors

Shaft		Mounting flange code with maximum torque in N·m [lb·in]						
Code	Description	01	02	B2	03	04	05	06
DB	Spline DIN 5482 B17x14-L14		130 [1151]	130 [1151]		130 [1151]	130 [1151]	
FA	Parallel Ø15-L30+Key 4x25	90 [797]						
GA	Parallel SAE Ø15,875-L23,8- Key 4x18							80 [708]
GB	Parallel SAE Ø15,875-L50,8- Key 4x40							80 [708]
SA	Spline SAE J498-9T-16/32							75 [646]
SB	Spline SAE J498-11T-16/32 (Version 2 only)							150 [1328]

Recommended mating splines for Group 2 splined output shafts should be in accordance with SAE J498 or DIN 5482. Danfoss external SAE splines are flat root side fit with circular tooth thickness reduced by 0.127 mm [0.005 in] in respect to class 1 fit. The external DIN splines have an offset increased by 0.1 mm [0.004 in.] These dimensions are modified in order to assure a clearance fit with the mating spline.

Other shaft options may exist. Contact your Danfoss representative for availability.

! Caution

Shaft torque capability may limit allowable pressure. Torque ratings assume no external radial loading. Applied torque must not exceed these limits, regardless of stated pressure parameters. Maximum torque ratings are based on shaft torsional fatigue strength.

Port dimensions

Available ports for Group 2 motors

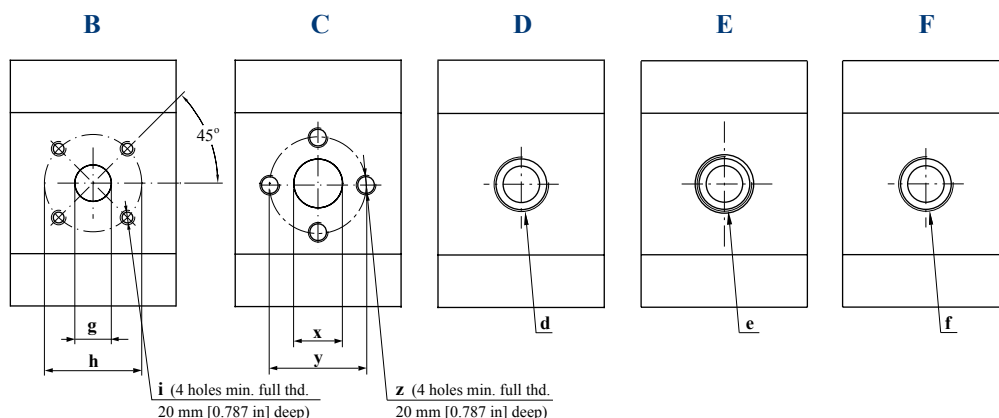

Group 2 Gear motors

Bidirectional motor ports dimensions

SNM2NN bidirectional motors and SNM2GN, SNM2JN, SNM2IN motors made unidirectional only by the valve

Port type			B			C			D	E	F	
Port dimensions			g	h	i	x	y	z	d	e	f	
Frame size	6,0	Inlet/Outlet	15 [0.59]	35 [1.38]	M6	13.5 [0.53]	30 [1.18]	M6	M22x1.5	7/8-14UNF-2B	½ Gas (BSPP)	
	8,0	Inlet/Outlet	15 [0.59]	35 [1.38]	M6	13.5 [0.53]	30 [1.18]	M6	M22x1.5	7/8-14UNF-2B	½ Gas (BSPP)	
	011	Inlet/Outlet	15 [0.59]	35 [1.38]	M6	13.5 [0.53]	30 [1.18]	M6	M22x1.5	7/8-14UNF-2B	½ Gas (BSPP)	
	014	Inlet/Outlet	15 [0.59]	35 [1.38]	M6	20 [0.79]	40 [1.58]	M8	M22x1.5	7/8-14UNF-2B	½ Gas (BSPP)	
	017	Inlet/Outlet	15 [0.59]	35 [1.38]	M6	20 [0.79]	40 [1.58]	M8	M22x1.5	7/8-14UNF-2B	½ Gas (BSPP)	
	019	Inlet/Outlet	20 [0.79]	40 [1.58]	M6	20 [0.79]	40 [1.58]	M8	M26x1.5	1-1/16-12UNF-2B	¾ Gas (BSPP)	
	022	Inlet/Outlet	20 [0.79]	40 [1.58]	M6	20 [0.79]	40 [1.58]	M8	M26x1.5	1-1/16-12UNF-2B	¾ Gas (BSPP)	
	025	Inlet/Outlet	20 [0.79]	40 [1.58]	M6	23.5 [0.92]	40 [1.58]	M8	M26x1.5	1-1/16-12UNF-2B	¾ Gas (BSPP)	
Drain			¼ Gas (BSPP)							9/16-18UNF-2B		¼ Gas (BSPP)

Group 2 Gear motors

Unidirectional motor ports dimensions

SNU2NN and SKU2NN ports dimensions

Port type		B			C			D	E	F	
Port dimensions		g	h	i	x	y	z	d	e	f	
Frame size	8,0	Inlet	15 [0.59]	35 [1.38]	M6	13.5 [0.53]	30 [1.18]	M6	M18x1.5	1-1/16-12UNF-2B	½ Gas (BSPP)
		Outlet	20 [0.79]	40 [1.58]	M6	13.5 [0.53]	30 [1.18]	M6	M16x1.5	7/8-14UNF-2B	½ Gas (BSPP)
	011	Inlet	15 [0.59]	35 [1.38]	M6	13.5 [0.53]	30 [1.18]	M6	M18x1.5	1-1/16-12UNF-2B	¾ Gas (BSPP)
		Outlet	20 [0.79]	40 [1.58]	M6	13.5 [0.53]	30 [1.18]	M6	M16x1.5	7/8-14UNF-2B	½ Gas (BSPP)
	014	Inlet	15 [0.59]	35 [1.38]	M6	13.5 [0.53]	30 [1.18]	M6	M18x1.5	1-1/16-12UNF-2B	¾ Gas (BSPP)
		Outlet	20 [0.79]	40 [1.58]	M6	20 [0.79]	40 [1.58]	M8	M16x1.5	7/8-14UNF-2B	½ Gas (BSPP)
	017	Inlet	15 [0.59]	35 [1.38]	M6	13.5 [0.53]	30 [1.18]	M6	M18x1.5	1-1/16-12UNF-2B	¾ Gas (BSPP)
		Outlet	20 [0.79]	40 [1.58]	M6	20 [0.79]	40 [1.58]	M8	M18x1.5	7/8-14UNF-2B	½ Gas (BSPP)
	019	Inlet	15 [0.59]	35 [1.38]	M6	13.5 [0.53]	30 [1.18]	M6	M18x1.5	1-1/16-12UNF-2B	¾ Gas (BSPP)
		Outlet	20 [0.79]	40 [1.58]	M6	20 [0.79]	40 [1.58]	M8	M18x1.5	7/8-14UNF-2B	½ Gas (BSPP)
	022	Inlet	15 [0.59]	35 [1.38]	M6	13.5 [0.53]	30 [1.18]	M6	M18x1.5	1-1/16-12UNF-2B	¾ Gas (BSPP)
		Outlet	20 [0.79]	40 [1.58]	M6	20 [0.79]	40 [1.58]	M8	M18x1.5	7/8-14UNF-2B	½ Gas (BSPP)
	025	Inlet	15 [0.59]	35 [1.38]	M6	13.5 [0.53]	30 [1.18]	M6	M18x1.5	1-1/16-12UNF-2B	1 Gas (BSPP)
		Outlet	20 [0.79]	40 [1.58]	M6	20 [0.79]	40 [1.58]	M8	M18x1.5	7/8-14UNF-2B	¾ Gas (BSPP)

Integral relief valve - SNM2IN

Danfoss offers an optional integral relief valve integrated in the Group 2 motors rear cover. It is drained internally and directs all the flow from the motor inlet to the outlet when the inlet pressure reaches the valve setting.

The tables in [Variant codes for ordering integral relief valve](#) on page 24 show applicable variant codes for ordering motors with integral relief valve. Refer to [Model code](#) on page 33 for more information.

Group 2 Gear motors

Valve schematic diagram

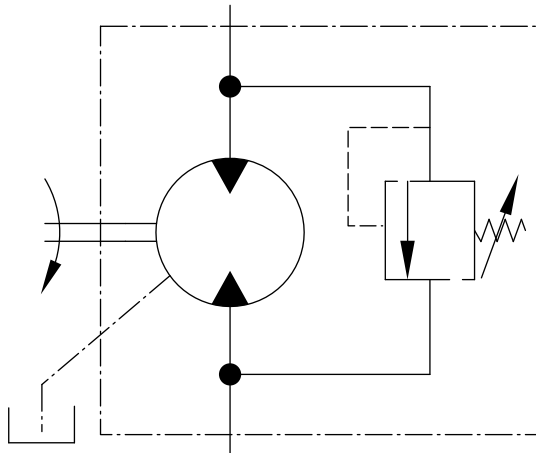

Integral relief valve rear cover cross section

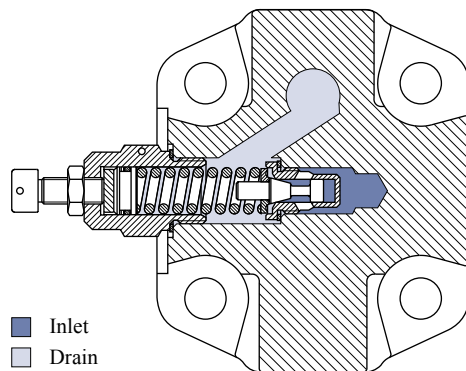

P101 016

Pressure vs flow

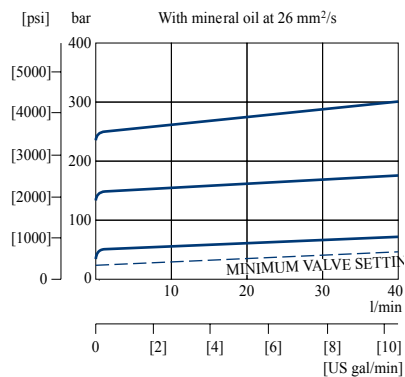

Variant codes for ordering integral relief valve

Variant codes for ordering integral relief valve

A	B	C	D	E	F	G	H	I	J	K	L	M	N	O
												/	V	•

Group 2 Gear motors

M Variant code (left part)

Code	Motor speed for RV setting min ⁻¹ (rpm)
A	not defined
C	500
E	1000
F	1250
G	1500
K	2000
I	2250
L	2500
M	2800
N	3000
O	3250

M Variant code (right part)

Code	Pressure setting bar [psi]
A	no setting
B	no valve
C	18 [261]
D	25 [363]
E	30 [435]
F	35 [508]
G	40 [580]
J	150 [2175]
K	50 [725]
L	60 [870]
M	70 [1015]
N	80 [1160]
O	90 [1305]
P	100 [1450]
Q	110 [1595]
R	120 [1740]
S	130 [1885]
T	140 [2030]
U	160 [2321]
V	170 [2466]
W	180 [2611]
X	210 [3046]
Z	250 [3626]

Group 2 Gear motors

Anti-cavitation check valve - SNM2GN

Danfoss offers an optional integral anti-cavitation check valve integrated in Group 2 motors bearing blocks. Available for all the displacements, the valve directs internally the flow from the motor outlet to the inlet, when the outlet pressure gets higher than the inlet one.

Valve schematic diagram

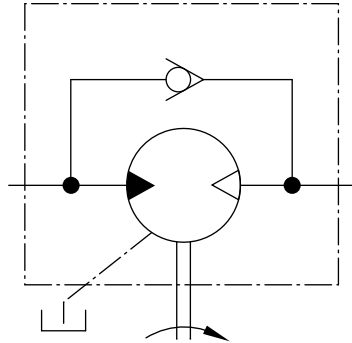

Anticavitation check valve cross section

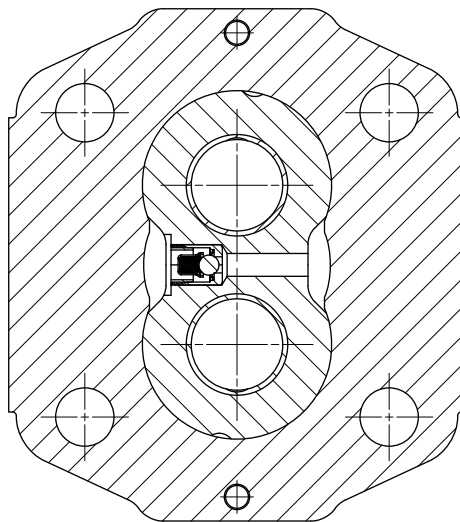

Integral relief valve and anti-cavitation check valve - SNM2JN

Danfoss offers the Group 2 motors with an optional integral relief valve integrated in the rear cover and anti-cavitation check valve integrated in the bearing block. The integral relief valve is drained internally and directs all the flow from the motor inlet to the outlet when the inlet pressure reaches the valve setting. The anti-cavitation check valve directs internally the flow from the motor outlet to the inlet, when the outlet pressure gets higher than the inlet one.

Group 2 Gear motors

Valve schematic diagram

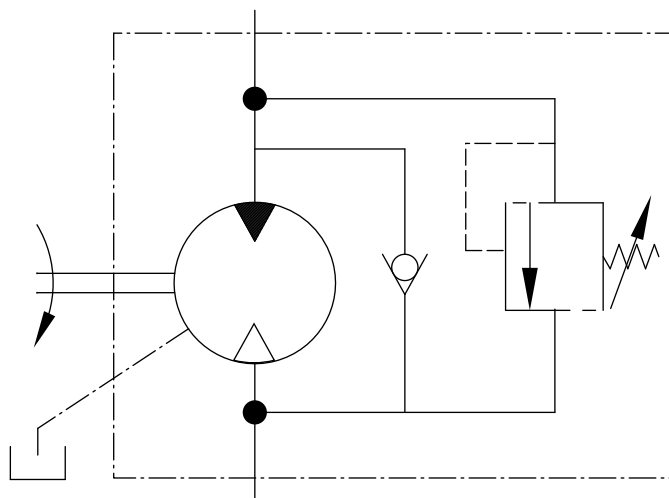

Outrigger bearing assembly - SNM2NN

An outrigger bearing is available for applications with high radial or thrust loads on the shaft. This option is used primarily for applications with high shaft loads. The design utilizes roller bearings in the front mounting flange. These bearings absorb the radial and thrust loads on the shaft so that the life of the motor is not affected. The use of roller bearings allows life to be described in B_{10} hours.

Available configurations

A	B	C	D	E	F	G	H	I	J	K	L	M	N	O
				•	•						/			

Flange/Shaft Code*	Mounting Flange	Shaft
9A	European 4-bolt	Taper 1:8
9F	German PTO	Taper 1:5
94	German 4-bolt	Taper 1:5
9H	SAE A	Taper 1:8
9J	SAE A	Parallel

* Codes represent assembly (complete motor with outrigger bearing).

The preceding table shows applicable variant codes for ordering motors with outrigger bearing. Refer to [M Set valves](#) on page 39 for more information.

Group 2 Gear motors

Allowable shaft loads

The following graphs show allowable shaft loads for 1000 hour life at 1500 min⁻¹ (rpm) versus distance from flange face to center of radial load.

Radial load vs distance from flange

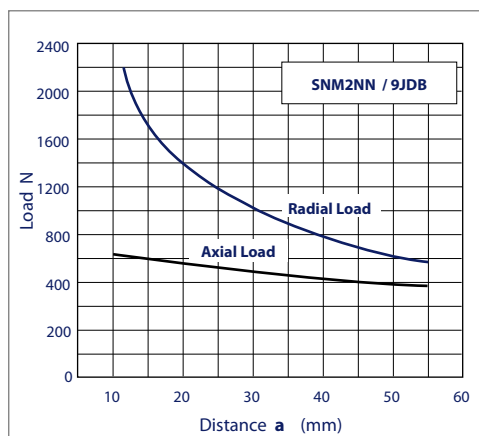
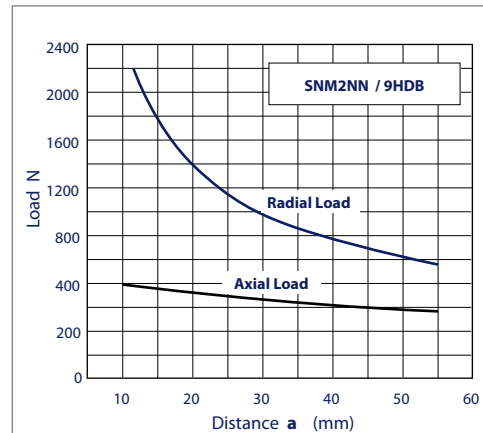
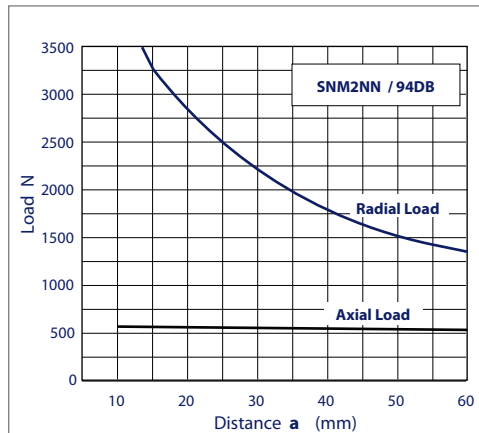
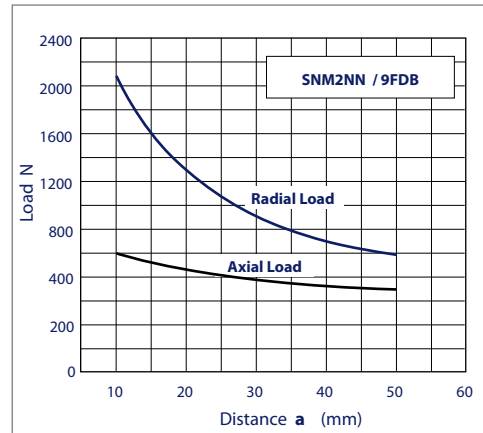
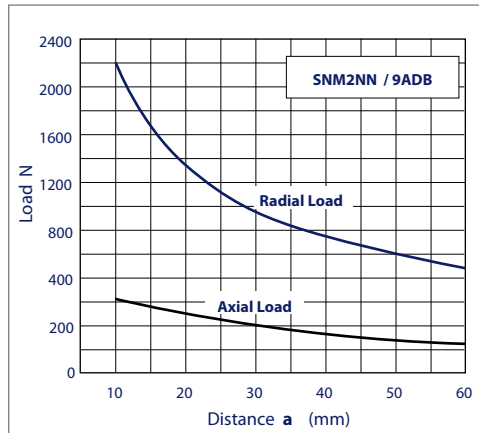

Group 2 Gear motors

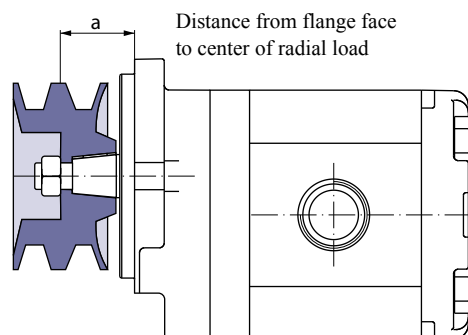

Group 2 Gear motors

Outrigger bearings 9A, 94, 9J, 9F, and 9H

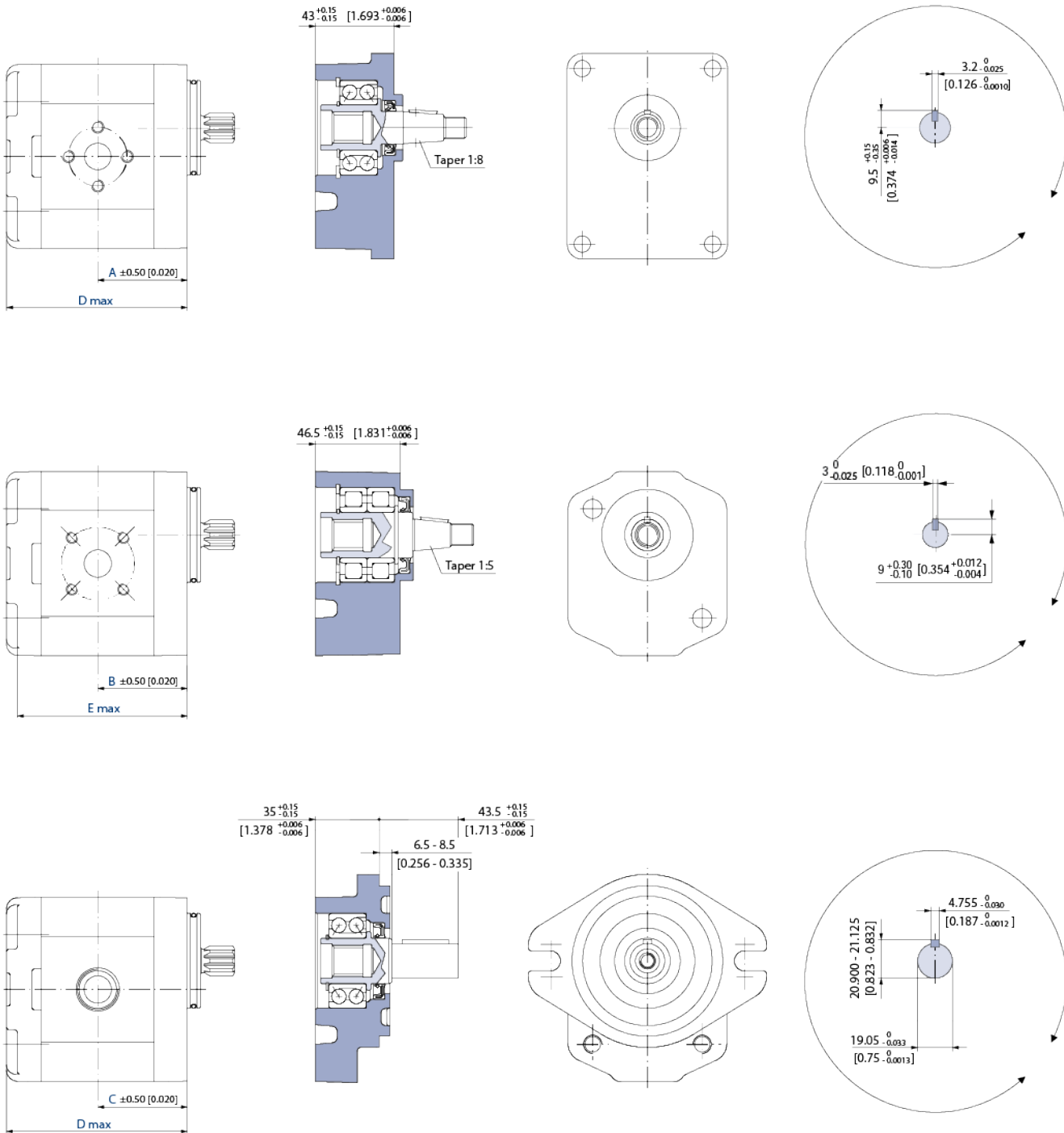

P005 276E

Group 2 Gear motors

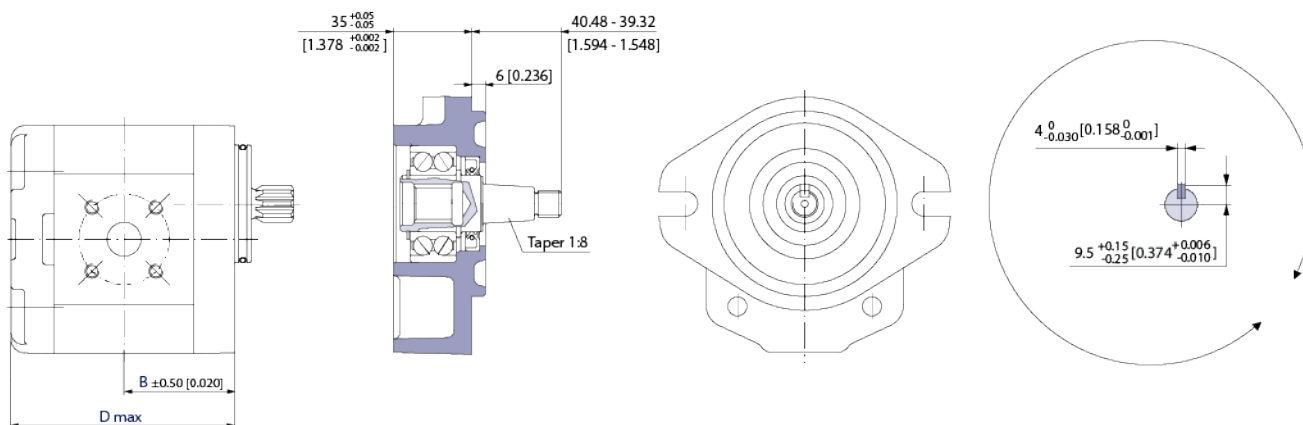
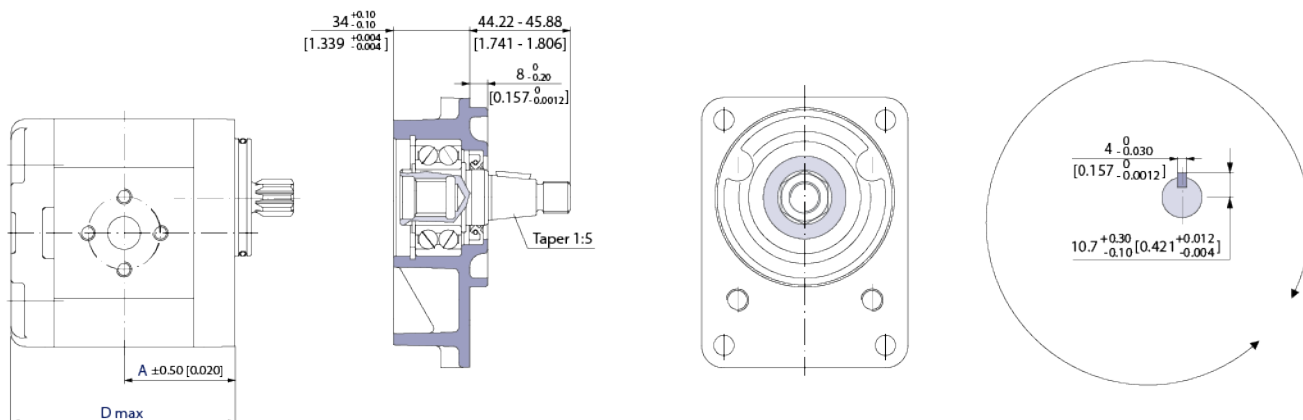

Shaft dimensions

Dimensions

Frame size		6.0	8.0	011	014	017	019	022	025
Dimension	A	45 [1.772]	45 [1.772]	49 [1.929]	52 [2.047]	52 [2.047]	56 [2.205]	59 [2.323]	59 [2.323]
	B	38.6 [1.520]	40.6 [1.598]	45 [1.772]	45 [1.772]	45 [1.772]	45 [1.772]	52.5 [2.067]	62 [2.441]
	C	45 [1.772]	47 [1.850]	49 [1.929]	52 [2.047]	54 [2.126]	56 [2.205]	59 [2.323]	61 [2.402]
	D	93.5 [3.681]	97.5 [3.839]	101.5 [3.996]	107.5 [4.232]	111.5 [4.390]	115.5 [4.574]	121.5 [4.783]	125.5 [4.941]
	E	85 [3.346]	89 [3.504]	93 [3.661]	99 [3.897]	103 [4.055]	107 [4.212]	113 [4.448]	117 [4.606]

Group 2 Gear motors

Dimensions

SNM2NN, SNU2NN – 01DA, 01FA and 01BA

Standard porting drawing for 01DA, 01FA and 01BA

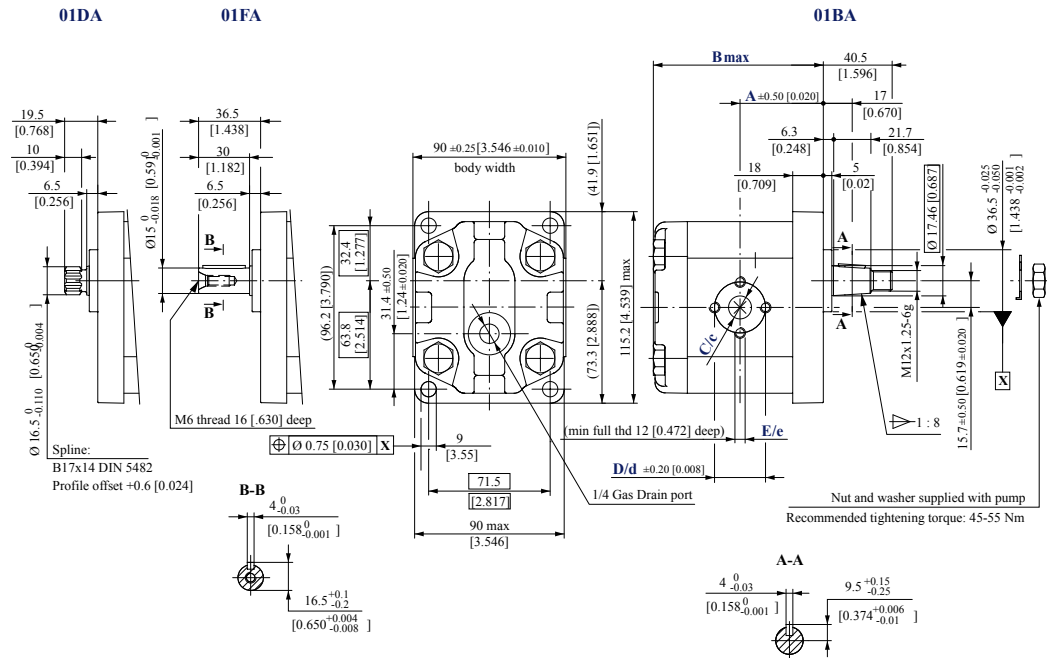

For unidirectional motors no case drain hole into the rear cover.

SKM1NN – 01BA dimensions

Frame size		6.0*	8.0	011	014	017	019	022	025	
Dimension	A	45 [1.771]		49 [1.929]	52 [2.047]		56 [2.204]		59 [2.322]	
	B	93.5 [3.681]	97.5 [3.838]	101.50 [3.996]	107.5 [4.232]		111.5 [4.389]	121.5 [4.783]	125.5 [4.940]	
Inlet/Outlet	C/c	13.5 [0.531]					20 [0.787]		23.5 [0.925]	
	D/d	30 [1.181]			40 [1.58]					
	E/e	M6			M8					

* Before choosing this frame size, please apply to Danfoss technical department

For unidirectional SNU2NN, SKU1NN dimensions see [Port dimensions](#) on page 45.

Model code examples and maximum shaft torque

Flange/drive gear	Model code example	Maximum shaft torque
01DA	SNM2NN/8,0BN01DAM1C3C3NNNN/NNNNN	90 N·m [797 lb·in]
01FA	SNM2NN/022BN01FAM1C7C7NNNN/NNNNN	90 N·m [797 lb·in]
01BA	SNM2NN/017BN01BAM1C7C7NNNN/NNNNN	150 N·m [1328 lb·in]

For further details on ordering, see [Model code](#) on page 33.

Group 2 Gear motors

SNM2NN, SNU2NN – 02DB and 02AA

Standard porting drawing for 02DB and 02AA

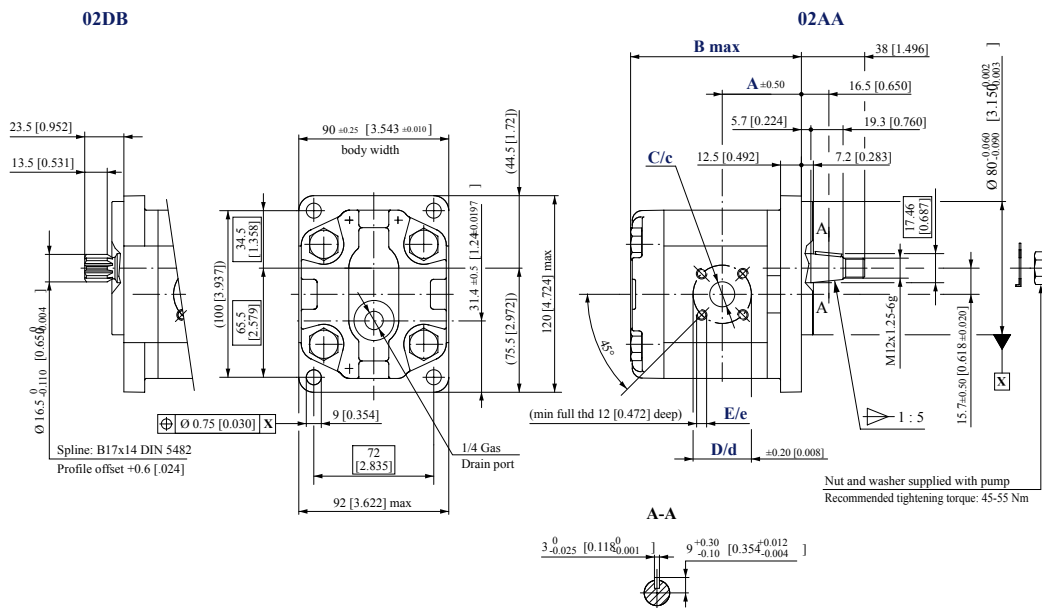

For unidirectional motors no case drain hole into the rear cover.

Bidirectional motors dimensions – 02DB and 02AA

Frame size	6,0*	8,0	011	014	017	019	022	025
A	41.1 [1.618]	43.1 [1.697]	47.5 [1.870]	47.5 [1.870]	47.5 [1.870]	55 [2.165]	64.5 [2.539]	
B	96 [3.780]	100 [3.937]	104 [4.094]	110 [4.331]	114 [4.488]	118 [4.646]	124 [4.882]	128 [5.039]
C/c	15 [0.591]				20 [0.79]			
D/d	35 [1.38]				40 [1.58]			
E/e	M6							

* Before choosing this frame size, please apply to Danfoss technical department.

For unidirectional SNU2NN dimensions, see [Port dimensions](#) on page 45.

Model code examples and maximum shaft torque

Flange/drive gear	Model code example	Maximum shaft torque
02DB	SNM2NN/025BN02DBM1B7B7NNNN/NNNNN	90 N·m [797 lb·in]
02AA	SNM2NN/8,0BN02AAM1B5B5NNNN/NNNNN	140 N·m [1239 lb·in]

For further details on ordering, see [Model code](#) on page 33.

Group 2 Gear motors

SNM2NN, SNU2NN-04DB/05DB and 04AA/05AA

Standard porting drawing for 04DB/05DB and 04AA/05AA

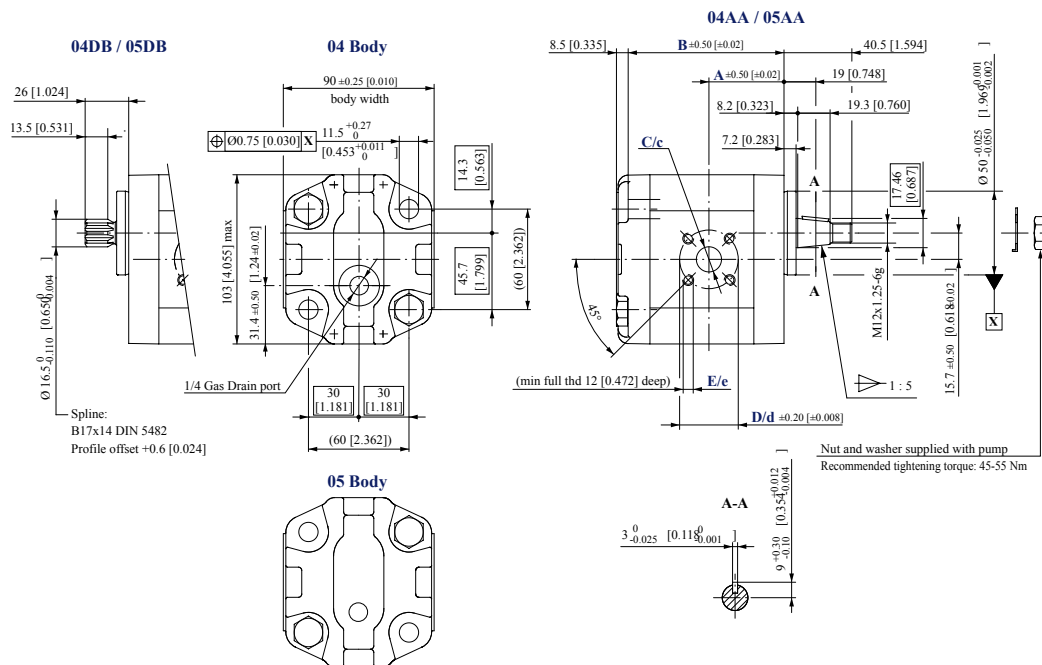

For unidirectional motors no case drain hole into the rear cover.

Bidirectional motors dimensions – 04/05DB and 04/05AA

Frame size		6,0*	8,0	011	014	017	019	022	025	
Dimension	A	38.6 [1.520]	40.6 [1.598]	45 [1.772]				52.5 [2.067]	62 [2.441]	
	B	85 [3.364]	89 [3.503]	93 [3.661]	99 [3.897]	103 [4.055]	107 [4.212]	113 [4.448]	117 [4.606]	
Inlet/Outlet	C/c	15 [0.591]					20 [0.79]			
	D/d	35 [1.38]					40 [1.58]			
	E/e	M6								

Before choosing this frame size, please apply to Danfoss technical department.

For unidirectional SNU2NN dimensions, see [Port dimensions](#) on page 45.

Model code examples and maximum shaft torque

Flange/drive gear	Model code example	Maximum shaft torque
04DB	SNM2NN/8,0BN04DBAM1B5B5NNNN/NNNNN	130 N·m [1151 lb·in]
05DB	SNM2NN/017BN05DBM1B5B5NNNN/NNNNN	
04AA	SNM2NN/8,0BN04AAM1B5B5NNNN/NNNNN	140 N·m [1239 lb·in]
05AA	SNM2NN/017BN05AAM1B5B5NNNN/NNNNN	

For further details on ordering, see [Model code](#) on page 33.

Group 2 Gear motors

SNM2NN, SNU2NN, SKU2NN – 06SA, 06GA

Standard porting drawing for 06SA and 06GA

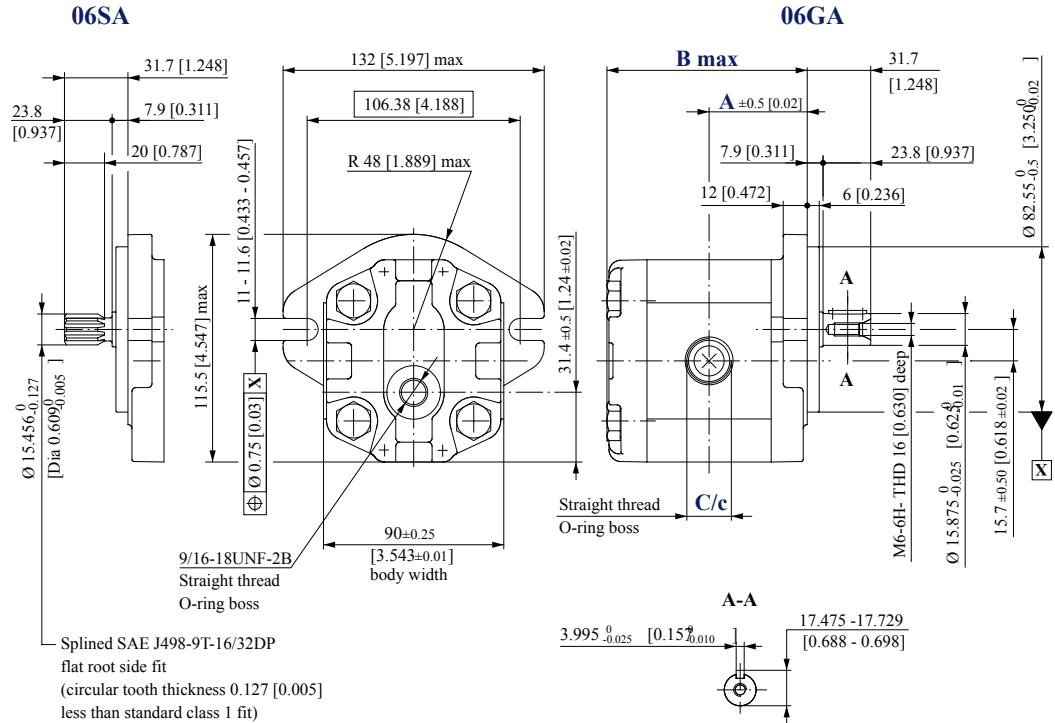

For unidirectional motors no case drain hole into the rear cover.

Bidirectional motors dimensions – 06SA and 06GA

Frame size		6,0*	8,0	011	014	017	019	022	025	
Dimension	A	45 [1.772]	47 [1.850]	49 [1.920]	52 [2.047]	54 [2.205]	56 [2.205]	59 [2.323]	61 [2.402]	
	B	93.5 [3.681]	97.5 [3.839]	101.5 [3.996]	107.5 [4.232]	111.5 [4.390]	115.5 [4.547]	121.5 [4.783]	125.5 [4.941]	
Inlet/Outlet	C/c	7/8-14UNF-2B, 16.7 [0.658] deep					1 1/16-12UNF-2B, 18.0 [0.709] deep			

* Before choosing this frame size, please apply to Danfoss technical department.

For unidirectional SNU2NN dimensions, see [Port dimensions](#) on page 45.

Group 3 Gear motors

Motor design

SNM3NN

SNM3NN is the Group 3 bidirectional motor available in the whole displacements range from 22 up to 90 cm³/rev [1.35 up to 5.38 in³/rev].

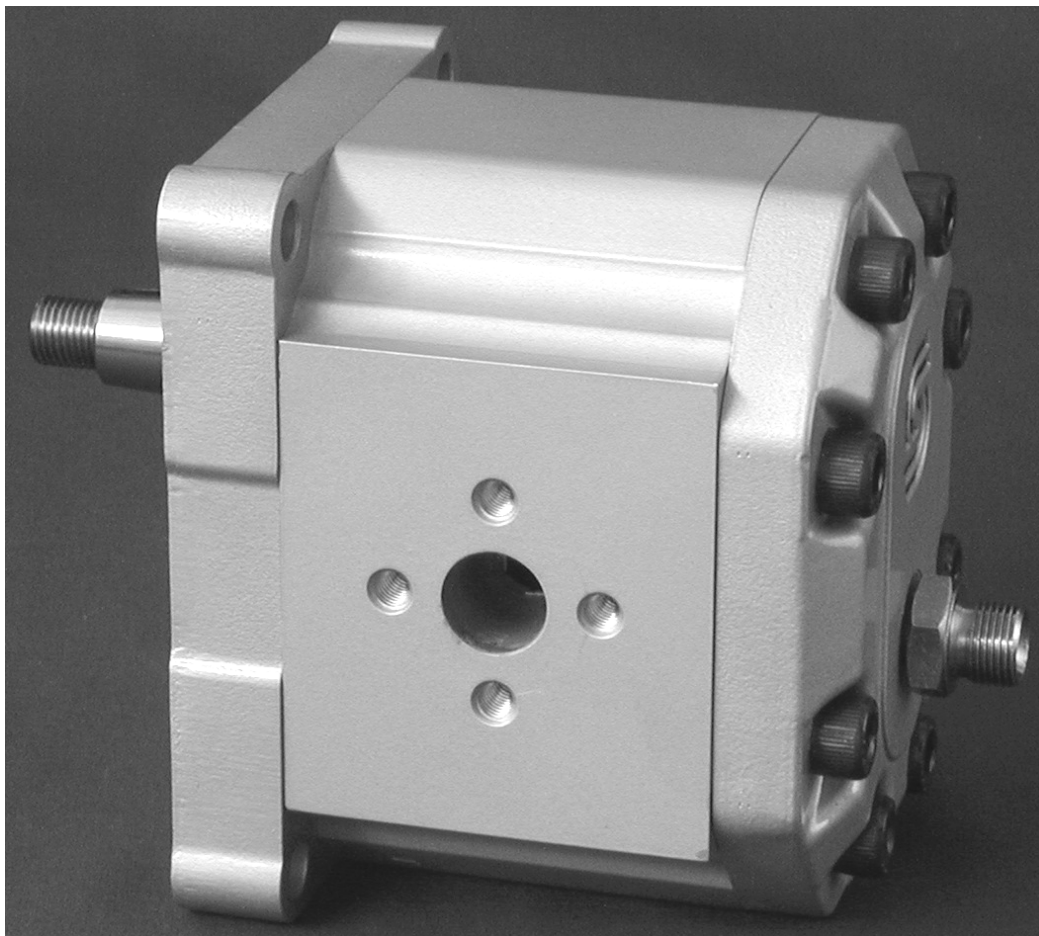

Configurations include European and SAE flanges and shafts (01BA, 01FA, 01DA, 02AA, 02FA, 02DB, 03BB, 03FB, 06AA, 06DD, 07BC, 07GA, 07SA).

Group 3 Gear motors

SNU3NN

SNU3NN is the Group 3 unidirectional motor available in the whole displacements range from 22 up to 90 cm³/rev [1.35 up to 5.38 in³/rev].

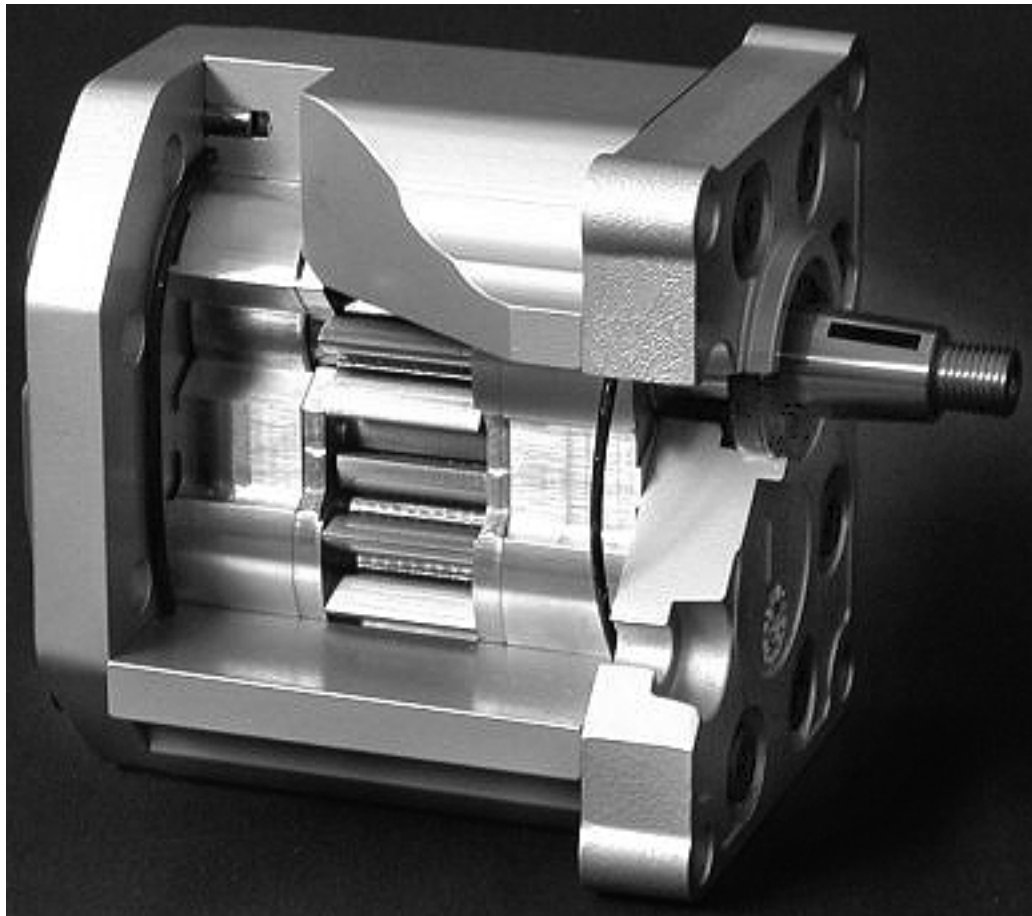

The SNU3NN motor construction is derived from the correspondent pump SNP3.

Configurations include European and SAE flanges and shafts (01BA, 01FA, 01DA, 02AA, 02FA, 02DB, 03BB, 03FB, 03DB, 06AA, 06SA, 07BC, 07GA, 07SA).

Technical data

This table details the technical data for Group 3 gear motors based on the model and displacement configuration.

Technical data for Group 3 gear motors

		Frame size									
		022	026	033	038	044	048	055	063	075	090
Displacement	cm ³ /rev	22.1	26.2	33.1	37.9	44.1	48.3	55.2	63.4	74.4	88.2
	[in ³ /rev]	[1.35]	[1.60]	[2.02]	[2.32]	[2.69]	[2.93]	[3.36]	[3.87]	[4.54]	[5.38]
SNU3NN (unidirectional)											
Peak pressure	bar [psi]	270	270	270	270	270	250	230	210	190	170
		[3915]	[3915]	[3915]	[3915]	[3915]	[3625]	[3336]	[3045]	[2755]	[2465]
Rated pressure		250	250	250	250	250	230	210	190	170	150
		[3625]	[3625]	[3625]	[3625]	[3625]	[3336]	[3045]	[2755]	[2465]	[2175]

Group 3 Gear motors

Technical data for Group 3 gear motors (continued)

		Frame size									
		022	026	033	038	044	048	055	063	075	090
Minimum speed	min-1 (rpm)	800	800	800	800	800	800	800	600	600	600
Maximum speed		2500	2500	2500	2500	2300	2300	2300	2300	2100	2100
SNM3NN (bidirectional) motor in parallel											
Peak pressure	bar [psi]	270 [3915]	270 [3915]	270 [3915]	270 [3915]	270 [3915]	250 [3625]	230 [3336]	210 [3045]	190 [2755]	170 [2465]
Rated pressure		250 [3625]	250 [3625]	250 [3625]	250 [3625]	250 [3625]	230 [3336]	210 [3045]	190 [2755]	170 [2465]	150 [2175]
Minimum speed	min-1 (rpm)	800	800	800	800	800	800	800	800	800	800
Maximum speed		2500	2500	2500	2500	2300	2300	2300	2300	2100	2100
SNM3NN (bidirectional) motor in series											
Peak pressure	bar [psi]	250 [3625]	250 [3625]	250 [3625]	250 [3625]	250 [3625]	230 [3336]	210 [3045]	190 [2755]	170 [2465]	150 [2175]
Rated pressure		250 [3625]	250 [3625]	250 [3625]	250 [3625]	250 [3625]	230 [3336]	210 [3045]	190 [2755]	170 [2465]	150 [2175]
Minimum speed	min-1 (rpm)	800	800	800	800	800	800	800	800	800	800
Maximum speed		2500	2500	2500	2500	2300	2300	2200	2100	2100	2100
All (SNU3NN, SNM3NN)											
Weight	kg [lb]	6.8 [15.0]	6.8 [15.0]	7.2 [15.8]	7.3 [16.1]	7.5 [16.5]	7.6 [16.8]	7.8 [17.3]	8.1 [17.9]	8.5 [18.7]	8.9 [19.6]
Moment of inertia of rotating components	x 10 ⁻⁶ kg·m ² [x 10 ⁻⁶ lb·ft ²]	198 [4698]	216 [5126]	246 [5837]	267.2 [6341]	294.2 [6981]	312.2 [7408]	342.3 [8123]	378.3 [8977]	426.4 [10 118]	486.5 [11 545]

1 kg·m² = 23.68 lb·ft²

! Caution

The rated and peak pressure mentioned are for motors with flanged ports only. When threaded ports are required a derated performance has to be considered. To verify the compliance of a high pressure application with a threaded ports pump apply to a Danfoss representative.

Model code

A Family

A	B	C	D	E	F	G	H	I	J	K	L	M	N	O
•	•	•	•	•	•	•	•	•	•	•	•	/	•	•

SNU3NN	Gr3 Unidirectional Motor
SNU3GN	Gr3 Unidirectional Motor+Anticav.Check Valve
SNM3NN	Gr3 Bidirectional Motor - Axial drain on cover
SNM3NL	Gr3 Bidirectional Motor-Vert.drain on rear cover
SNM3GN	Gr3 Bidirectional Motor-Anticav.Check Valve - Axial drain on cover
SNM3GL	Gr3 Bidirectional Motor-Anticav.Check Valve - Vert.drain on rear cover
SNM3DN	Gr3 Bidirectional Motor-Internal drain valve

Group 3 Gear motors

B Displacement

A				B			C	D	E	F	G	H	I	J	K	L	M			N	O
				•	•	•											/				

022	22,1 cc
026	26,2 cc
033	33,1 cc
038	37,9 cc
044	44,1 cc
048	48,3 cc
055	55,2 cc
063	63,4 cc
075	74,4 cc
090	88,2 cc

C Rotation

A				B			C	D	E	F	G	H	I	J	K	L	M			N	O
							•										/				

L	Left hand
R	Right hand
B	Bidirectional

D Project version (value representing a change to the initial project)

A				B			C	D	E	F	G	H	I	J	K	L	M			N	O
							•										/				

N	Std Version of Project
----------	------------------------

E Mounting flange

A				B			C	D	E	F	G	H	I	J	K	L	M			N	O
									•	•							/				

Code	Description (Type of flange • Type of drive gear • Preferred ports for configuration)
01	Pilot Ø50,8+4 holes (98,4x128,1)
02	Pilot Ø50,8+4 holes (98,4x137)
03	Pilot Ø60,3+4 holes (114,3x149,5)
06	Pilot Ø105+4 holes (102,0x145,0)
07	SAE B-pilot Ø101,6 -2 holes
08	SAE C-pilot Ø127 -4 holes
09	SAE A-pilot Ø82,55 -2 holes
91	Outriggerbearing typo 01 -Taper 1:8 M14x1,5 key 4x7,5

Group 3 Gear motors

Code	Description(Type of flange • Type of drive gear • Preferred ports for configuration)
9Y	Outrigger bearing type 07 -taper shaft 1:8-5/8-18UNF-Key6,375 with Dust Cover
B1	PilotØ50,8+4 holes special shaft seal slot - Special 01
D6	PilotØ105+4 holes + shaft seal D40 per shaft spline - Special 06
D7	PilotØ101,6+2 holes + double shaft seal - Special 07
P1	Pilot Ø50,8+4 holes Ø12-12,5 - Special 01
P7	PilotØ101,6+2 fixed holes slot - Special 07

F Drive Gear

A	B	C	D	E	F	G	H	I	J	K	L	M	N	O
					•	•						/		

AA	Taper 1:5-M16x1,5-Key 5
BA	Taper 1:8-M14x1,5-Key 4
BB	Taper 1:8-M16x1,5-Key 4,79
BC	Taper 1:8-5/8-18UNF-2A-Key 6,375
BD	Taper 1:8-M14x1,5-Key4 + thd hole M8 - Special
BP	Taper 1:8-5/8-18UNF-2A-Key 6,375 with NUT & WASHER (for flange 07)
CA	Tang 8xØ22,2 - Special
DA	DIN5482 B22x19 L=24 (for flange typo 01)
DD	DIN 5482 B28x25 L28 (for flange typo 06)
FA	ParallelØ20-Key 5x5 L30 (for flange typo 01-02)
FB	Parallel Ø22-Key 5x5 L40 (for flange typo 03)
GA	Parallel Ø22,225 x L25,4-Key 6,375x6,375 L25,4
GB	ParallelØ22,225xL25,4-Key 6,375x6,375x25,4+thd hole:1/4-20UNC-2B
SA	SAE J498-13T-16/32-SAE B
SB	SAEJ498-13T-16/32-SAE A (for flange typo 09)
RA	SAEJ498-14T-12/24-SAE C-4 bolt (for flange typo 08)
SH	SAE J498-15T-16/32-(for flange typo 07)

G Rear Cover

A	B	C	D	E	F	G	H	I	J	K	L	M	N	O
						•	•					/		

P1	Std cover for unidirectional motors
M1	Std cover motor axial drain on cover M14x1,5
M2	Std cover motor axial drain on cover M12x1,5 ISO6149
M6	Std cover motor axial drain on cover 9/16-18UNF-2B
MF	Std cover motor axial drain on cover drain 3/8 Gas

Group 3 Gear motors

L1	Cover motor with radial drain on cover - Vertical M14x1,5
L2	Cover motor with radial drain on cover - Horizontal M14x1,5
L6	Cover motor with radial drain on cover - Vertical 9/16-18UNF-2B
LT	Cover motor with radial drain on cover - Vertical 9/16-18UNF-2B drain up
C1	Cover motor with front metric ports : M22x1,5 - for SNM3CN series
D1	Cover motor without drain (internal drained) - for SNM3DN series

H Inlet size; I Outlet size

A				B	C	D	E	F	G	H	I	J	K	L	M	N	O	
										•	•	•	•					/

A2	18,5x22,23x47,63x3/8-16UNC	
A3	25x26,19x52,37x3/8-16UNC	
A4	31x30,18x58,72x7/16-14UNC	
A5	37,5/27x35,71x69,85x1/2-13UNC	
B7	20x40xM6	
BA	18x55xM8	
BB	27x55xM8	
BC	36/27x55xM8	
C3	13,5x30xM6	
C7	20x40xM8	
CA	27x51xM10	
CD	36x62xM10	
CZ	27x51xM10(2 Vert.Holes)	
G7	20x40x5/16-18UNC- Special	
GA	27x51x3/8-16UNC - Special	
E5	7/8-14UNF	
E6	1-1/16-12UN	
E8	1-5/16-12UN	
E9	1-5/8-12UN	
EA	1-7/8-12UN	
H8	M27x2-ISO6149	
H9	M33x2-ISO6149	
F5	BSP 3/4 GAS	
F6	BSP 1 GAS	
F7	BSP 1-1/4 GAS	

Group 3 Gear motors

M5	25x52,37x26,19xM10	
M6	31x30,18x58,72xM10	
M7	37,5x35,71x69,85xM12	
MF	25x52,37x26,19xM8 deep12 Horiz	
MG	25/20x52,37x26,19xM10(=) - Special	
MH	31x30,18x58,72xM10 deep18 (=)	
MN	31x30,18x58,72xM10 deep12 (=)	
MR	37,5x35,71x69,85xM12 deep20 (=)	

J Ports pos & Spec body

A	B	C	D	E	F	G	H	I	J	K	L	M	N	O
									•	•	/			

NN	Std from catalog
PL*	Inlet port Left position looking gear drive from front flange
*PR	Inletport Right position looking gear drive from front flange
ZZ	Port Bx-Bx in the center of the body - Option

* to be used if inlet-outlet are different

K Seals

A	B	C	D	E	F	G	H	I	J	K	L	M	N	O
										•	/			

N	Standard NBR seals
B	VITON seals - Option
D	NBR seals + VITON shaft seal with dust lip
X	NBR seals + Dust Cover - Option
Y	VITON seals + Dust Cover - Option
Z	VITON shaft seal + Dust Cover - Option

L Screws

A	B	C	D	E	F	G	H	I	J	K	L	M	N	O
											•	/		

N	Std burnished screws
B	Dacromet/Geomer - Anticorrosion screws

M Set valves

A	B	C	D	E	F	G	H	I	J	K	L	M	N	O
											/	•	•	•

NNN	No valve
------------	----------

Group 3 Gear motors

N Type of mark

A				B	C	D	E	F	G	H	I	J	K	L		M	N	O
															/			•

N	Standard Danfoss Marking
A	Standard Danfoss Marking+Customer Code-Special
Z	Without Marking

O Mark position

A				B	C	D	E	F	G	H	I	J	K	L		M	N	O
															/			•

N	Std Marking position (on top)
A	Special Marking position on the bottom

Motor performance graphs

The following graphs on the next pages provide typical inlet flow and output power for Group 3 motors at various working pressures. Data were taken using ISO VG46 petroleum /mineral based fluid at 50 °C [122 °F] (viscosity = 28 mm²/s [132 SUS]).

Group 3 Gear motors

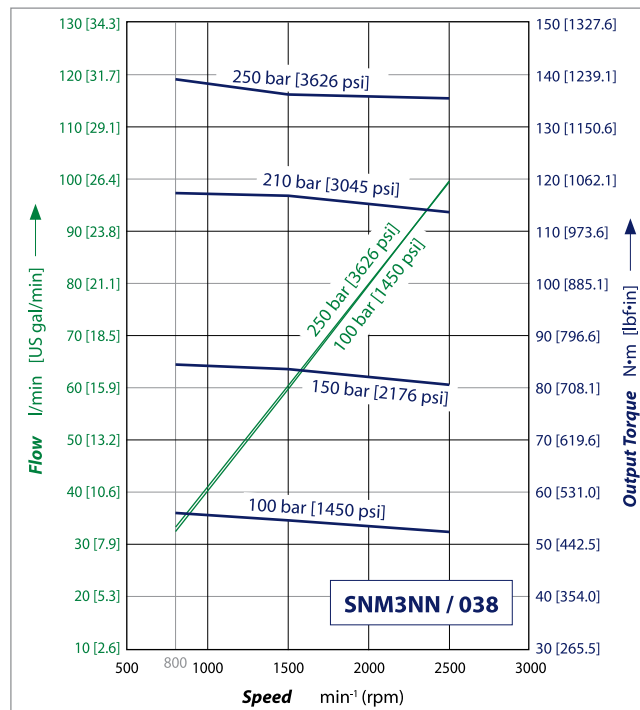
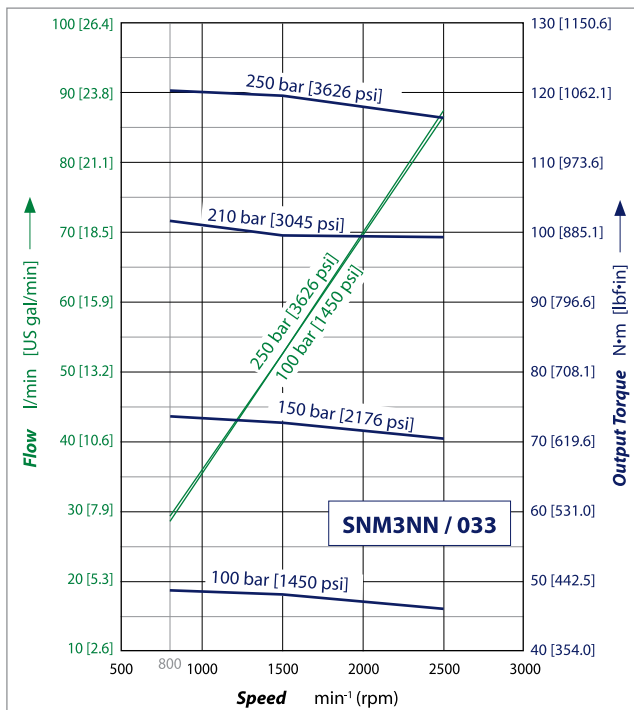
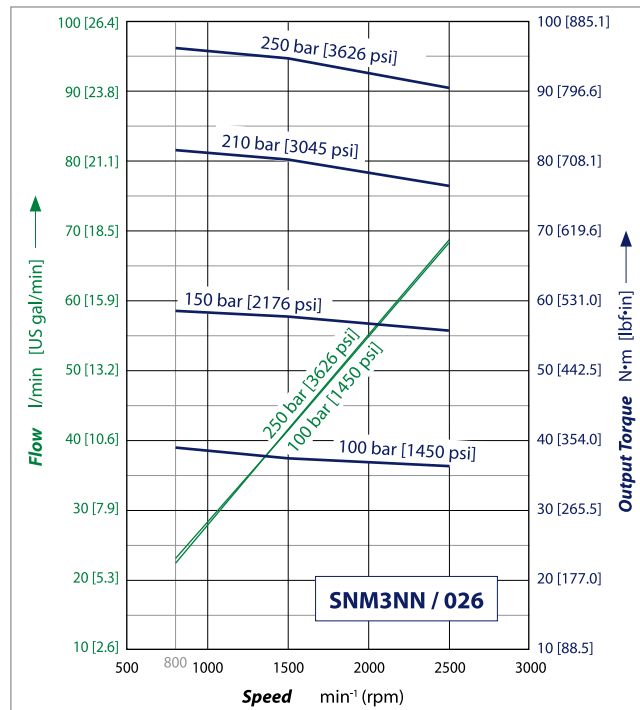
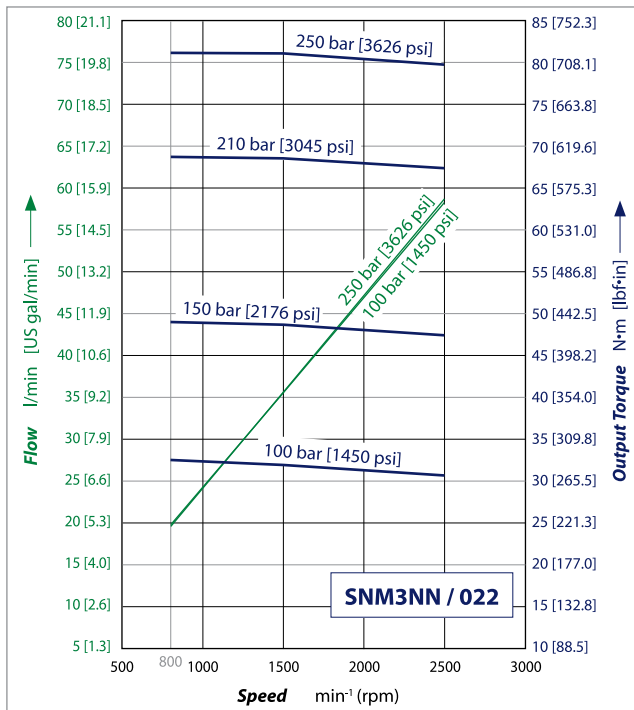

Group 3 Gear motors

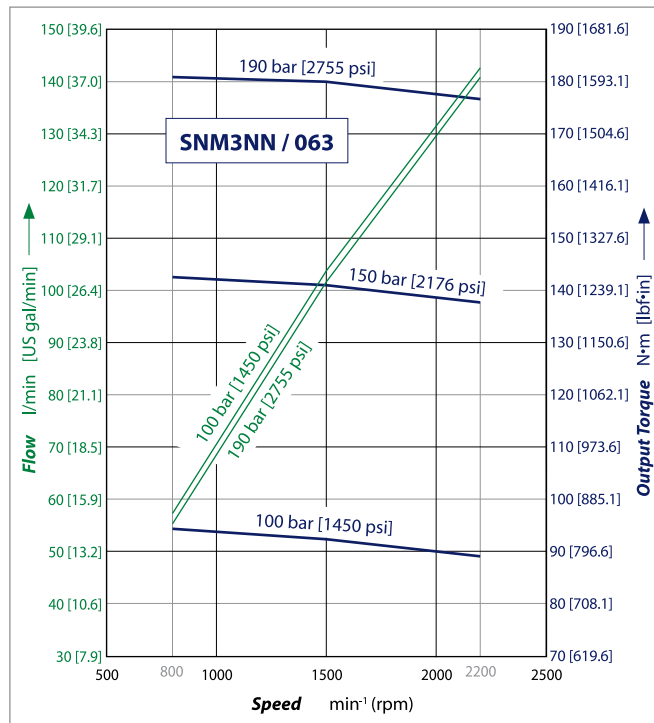
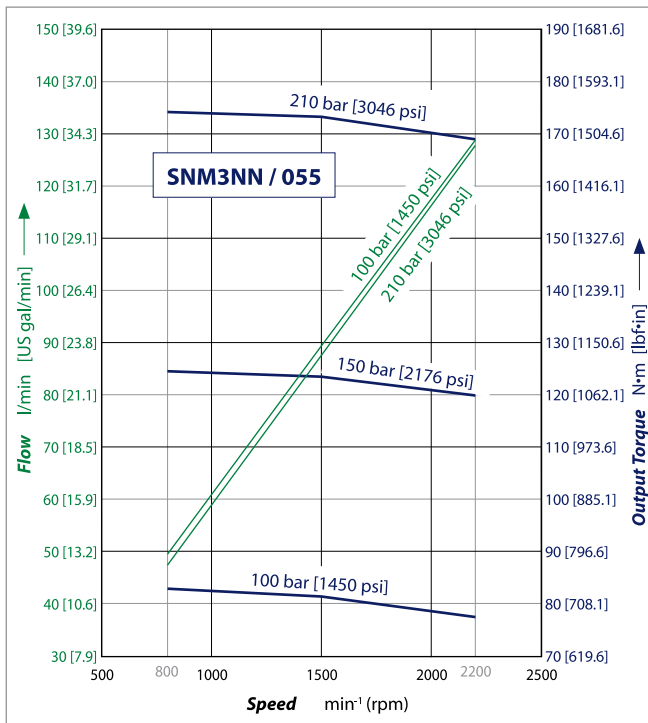
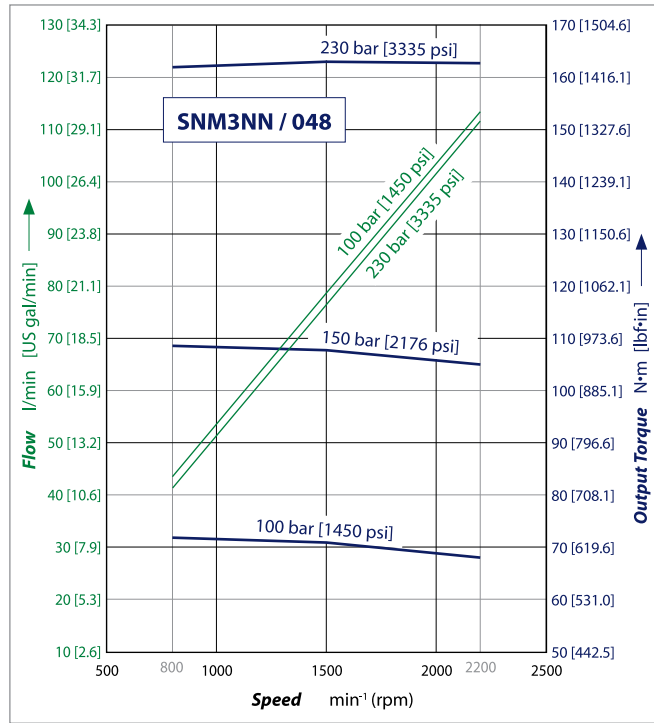
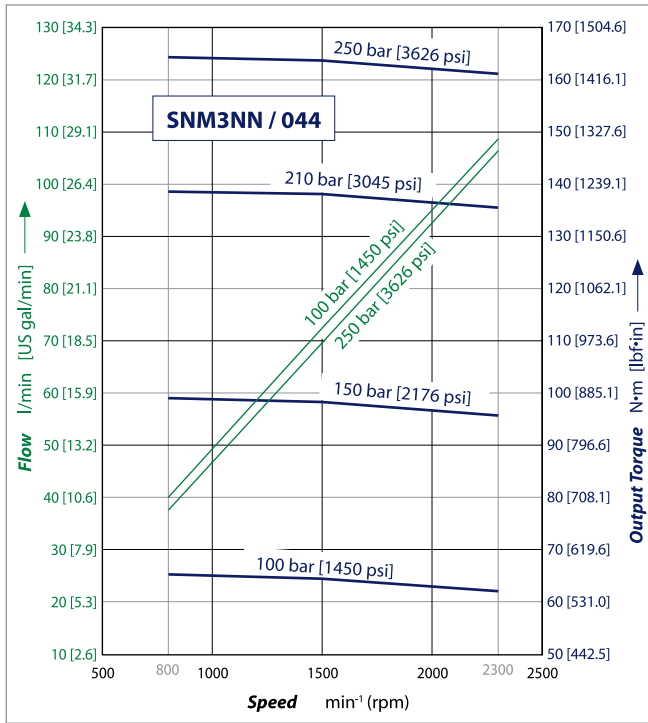

Group 3 Gear motors

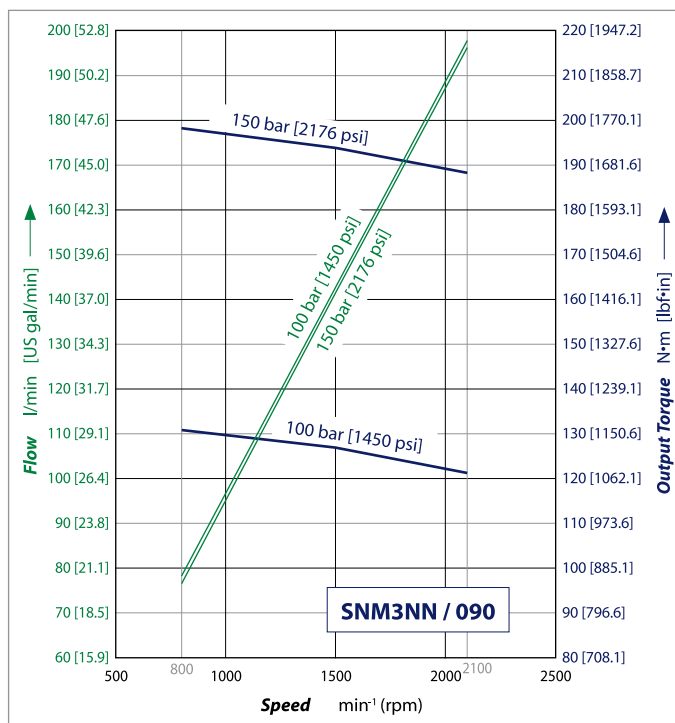
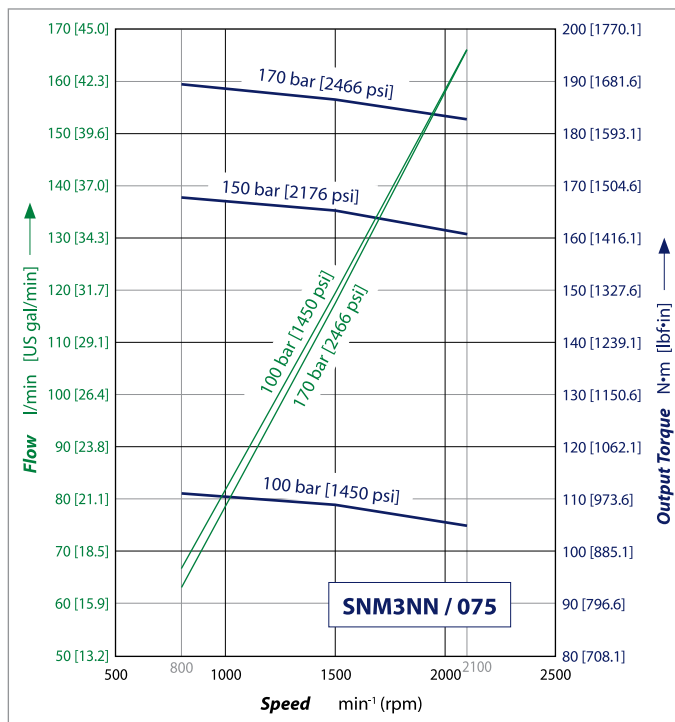

Group 3 Gear motors

Flange, shaft, and port configurations

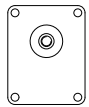
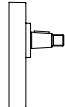
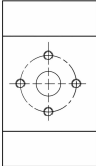
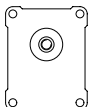
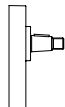
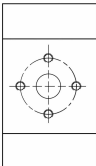
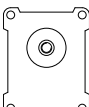
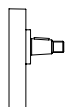
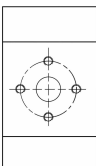
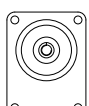
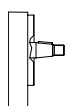
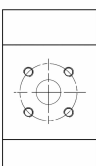
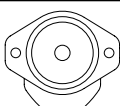
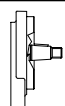
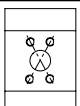
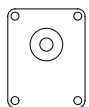
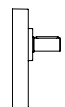
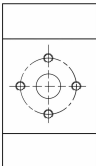
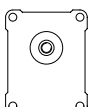
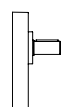
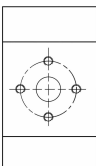
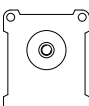
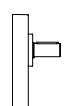
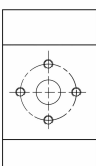
Motor	Code	Flange	Shaft	Port
SNM3NN SNU3NN SNM3GN	01BA	pilot Ø 50.8 mm [2.0 in] European 01 4- bolt 	1:8 tapered 	European flanged port + pattern 
SNM3NN SNU3NN SNM3GN	02BA	pilot Ø 50.8 mm [2.0 in] European 02 4- bolt 	1:8 tapered 	European flanged port + pattern 
SNM3NN SNU3NN SNM3GN	03BB	pilot Ø 60.3 mm [2.374 in] European 03 4- bolt 	1:8 tapered 	European flanged port + pattern 
SNM3NN SNU3NN SNM3GN	06AA	pilot Ø 105 mm [4.133 in] German 4-bolt 	1:5 tapered 	German std ports port X pattern 
SNM3NN SNU3NN SNM3GN	07BC	SAE B pilot Ø 101.6 2- bolt 	1:8 tapered 	Vertical four bolt flanged port 
SNM3NN SNU3NN SNM3GN	01FA	pilot Ø 50.8 mm [2.0 in] European 01 4- bolt 	Ø 20 mm [0.787 in] parallel 	European flanged port + pattern 
SNM3NN SNU3NN SNM3GN	02FA	pilot Ø 50.8 mm [2.0 in] European 02 4- bolt 	Ø 20 mm [0.787 in] parallel 	European flanged port + pattern 
SNM3NN SNU3NN SNM3GN	03FB	pilot Ø 60.3 mm [2.374 in] European 03 4- bolt 	Ø 22 mm [0.866 in] parallel 	European flanged port + pattern 

Group 3 Gear motors

Motor	Code	Flange	Shaft	Port
SNM3NN SNU3NN SNM3GN	07GA	SAE B pilot Ø 101.6 mm 2-bolt	Ø 22.225 mm [0.875 in] parallel	Vertical four bolt flanged port
SNM3NN SNU3NN SNM3GN	01DA	pilot Ø 50.8 mm [2.0 in] European 01 4- bolt	Splined shaft 13T – m 1.60 DIN 5482 – B22 x 19	European flanged port + pattern
SNM3NN SNU3NN SNM3GN	02DB	pilot Ø 50.8 mm [2.0 in] European 02 4- bolt	Splined shaft 13T – m 1.60 DIN 5482 – B22 x 19	European flanged port + pattern
SNM3NN SNU3NN SNM3GN	06DD	pilot Ø 105 mm [4.133 in] German 4-bolt	Splined shaft 15T – m 1.60 DIN 5482 – B28 x 25	German std ports port X pattern
SNM3NN SNU3NN SNM3GN	07SA	SAE B pilot Ø 101.6 mm 2-bolt	Splined shaft SAE J498 13T – 16/32DP	Vertical four bolt flanged port

Shaft and flange availability

This table details the standard Group 3 shafts and flange combinations that are currently available with the maximum shaft torque limits.

Shaft		Mounting flange code with maximum torque in Nm [lb*in]				
Code	Description	01	02	03	06	07
AA	Taper 1:5-M16x1,5-Key 5				300 [2655]	
BA	Taper 1:8-M14x1,5-Key 4	350 [3097]	350 [3097]			
BB	Taper 1:8-M16x1,5-Key 4,79			500 [4425]		
BC	Taper 1:8-5/8-18UNF-2A-Key 6,375					300 [2655]
BD	Taper 1:8-M14x1,5-Key 4 + thd hole M8 - Special	350 [3097]	350 [3097]			
BP	Taper 1:8-5/8-18UNF-2A-Key 6,375 with NUT & WASHER (for flange 07)					300 [2655]
CA	Tang 8xØ22,2 - Special					**
CB	Tang 12xØ24-shaft flange protrusion sb17.5-dr72.5-Special			**		
DA	DIN 5482 B22x19 L=24 (for flange typo 01)	290 [2566]	290 [2566]			

Group 3 Gear motors

Shaft		Mounting flange code with maximum torque in Nm [lb*in]				
Code	Description	01	02	03	06	07
DD	DIN 5482 B28x25 L28 (for flange typo 06)				450 [3982]	
FA	Parallel Ø20-Key 5x5 L30 (for flange typo 01-02)	210 [1858]	210 [1858]			
FB	Parallel Ø22-Key 5x5 L40 (for flange typo 03)			300 [2655]		
GA	Parallel Ø22,225 x L25,4-Key 6,375x6,375 L25,4					230 [2035]
GB	Parallel Ø22,225xL25,4- Key 6,375x6,375x25,4+thd hole: 1/4-20UNC-2B					230 [2035]
GC	Parallel Ø22,225xL25,4- Key 6,375x6,375x25,4+thd hole:5/16-18UNC-2B - Special					230 [2035]
SA	SAE J498-13T-16/32-SAE B					270 [2389]
SB	SAE J498-13T-16/32-SAE A (for flange typo 09)					270 [2389]
RA	SAE J498-14T-12/24-SAE C-4 bolt (for flange typo 08)					400 [3540]
SH	SAE J498-15T-16/32-(for flange typo 07)					400 [3540]

Ports dimensions

Bidirectional motor ports

Available ports for Group 3 bidirectional motors

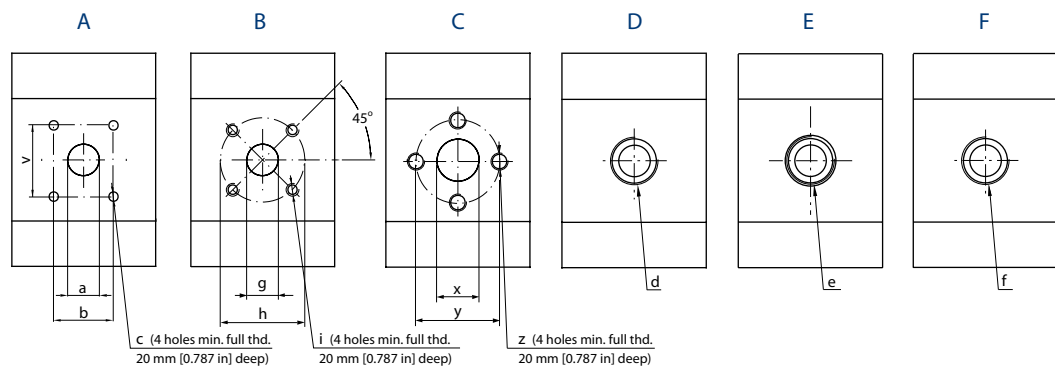

Group 3 Gear motors

Ports dimensions for bidirectional motors SNM3NN

Port type		A				B			C			D	E	F
Dimensions		a	b	v	c	g	h	i	x	y	z	d	e	f
Frame size	022	25.4 [1.0]	26.19 [1.031]	52.37 [2.061]	3/8-16UNC-2B	27 [1.063]	55 [2.165]	M8	20 [0.79]	40 [1.58]	M8	M26x1.5	15/16-12UN-2B	3/4 Gas (BSPP)
	026	25.4 [1.0]	26.19 [1.031]	52.37 [2.061]	3/8-16UNC-2B	27 [1.063]	55 [2.165]	M8	20 [0.79]	40 [1.58]	M8	M26x1.5	15/16-12UN-2B	3/4 Gas (BSPP)
	033	31.8 [1.251]	30.18 [1.188]	58.72 [2.311]	7/16-14UNC-2B	27 [1.063]	55 [2.165]	M8	27 [1.063]	51 [2.008]	M10	M33x2	15/8-12UN-2B	1 Gas (BSPP)
	038	31.8 [1.251]	30.18 [1.188]	58.72 [2.311]	7/16-14UNC-2B	27 [1.063]	55 [2.165]	M8	27 [1.063]	51 [2.008]	M10	M33x2	15/8-12UN-2B	1 Gas (BSPP)
	044	31.8 [1.251]	30.18 [1.188]	58.72 [2.311]	7/16-14UNC-2B	27 [1.063]	55 [2.165]	M8	27 [1.063]	51 [2.008]	M10	M33x2	15/8-12UN-2B	1 Gas (BSPP)
	048	31.8 [1.251]	30.18 [1.188]	58.72 [2.311]	7/16-14UNC-2B	27 [1.063]	55 [2.165]	M8	27 [1.063]	51 [2.008]	M10	M33x2	15/8-12UN-2B	1 Gas (BSPP)
	055	31.8 [1.251]	30.18 [1.188]	58.72 [2.311]	7/16-14UNC-2B	27 [1.063]	55 [2.165]	M8	27 [1.063]	51 [2.008]	M10	M33x2	15/8-12UN-2B	1 Gas (BSPP)
	063	31.8 [1.251]	30.18 [1.188]	58.72 [2.311]	7/16-14UNC-2B	36 [1.417]	55 [2.165]	M8	36 [1.417]	62 [2.441]	M10	M33x2	15/8-12UN-2B	1/4 Gas (BSPP)
	075	31.8 [1.251]	30.18 [1.188]	58.72 [2.311]	7/16-14UNC-2B	36 [1.417]	55 [2.165]	M8	36 [1.417]	62 [2.441]	M10	M33x2	15/8-12UN-2B	1/4 Gas (BSPP)
	090	31.8 [1.251]	30.18 [1.188]	58.72 [2.311]	7/16-14UNC-2B	36 [1.417]	55 [2.165]	M8	36 [1.417]	62 [2.441]	M10	M33x2	15/8-12UN-2B	1/4 Gas (BSPP)
Drain		M14 x 1.5											9/16-18UNF-2B	

Unidirectional motor ports

Available ports for Group 3 unidirectional motors

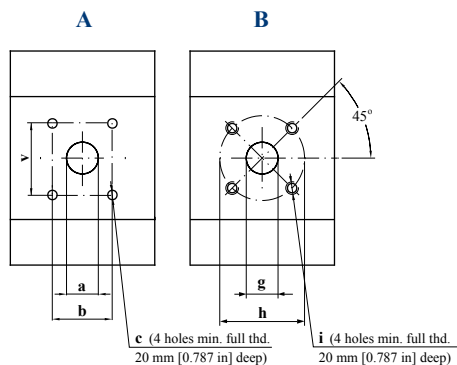

Group 3 Gear motors

Ports dimensions for unidirectional motors SNU3NN

Port type			A				B		
Dimensions			a	b	c	v	g	h	i
Frame size	022	Outlet	20 [0.79]	40 [1.58]	M8	3/8-16UNC-2B	27 [1.063]	55 [2.165]	M8
		Inlet	20 [0.79]	40 [1.58]	M8	3/8-16UNC-2B	18 [0.709]	55 [2.165]	M8
	026	Outlet	20 [0.79]	40 [1.58]	M8	3/8-16UNC-2B	27 [1.063]	55 [2.165]	M8
		Inlet	20 [0.79]	40 [1.58]	M8	3/8-16UNC-2B	18 [0.709]	55 [2.165]	M8
	033	Outlet	27 [1.063]	51 [2.008]	M10	7/16-14UNC-2B	27 [1.063]	55 [2.165]	M8
		Inlet	20 [0.79]	40 [1.58]	M8	3/8-16UNC-2B	18 [0.709]	55 [2.165]	M8
	038	Outlet	27 [1.063]	51 [2.008]	M10	7/16-14UNC-2B	27 [1.063]	55 [2.165]	M8
		Inlet	20 [0.79]	40 [1.58]	M8	3/8-16UNC-2B	18 [0.709]	55 [2.165]	M8
	044	Outlet	27 [1.063]	51 [2.008]	M10	7/16-14UNC-2B	27 [1.063]	55 [2.165]	M8
		Inlet	27 [1.063]	51 [2.008]	M10	3/8-16UNC-2B	18 [0.709]	55 [2.165]	M8
	048	Outlet	27 [1.063]	51 [2.008]	M10	7/16-14UNC-2B	27 [1.063]	55 [2.165]	M8
		Inlet	27 [1.063]	51 [2.008]	M10	3/8-16UNC-2B	18 [0.709]	55 [2.165]	M8
	055	Outlet	27 [1.063]	51 [2.008]	M10	1/2-13UNC-2B	27 [1.063]	55 [2.165]	M8
		Inlet	27 [1.063]	51 [2.008]	M10	7/16-14UNC-2B	18 [0.709]	55 [2.165]	M8
	063	Outlet	36 [1.417]	62 [2.441]	M10	1/2-13UNC-2B	36 [1.417]	55 [2.165]	M8
		Inlet	27 [1.063]	51 [2.008]	M10	7/16-14UNC-2B	27 [1.063]	55 [2.165]	M8
	075	Outlet	36 [1.417]	62 [2.441]	M10	1/2-13UNC-2B	36 [1.417]	55 [2.165]	M8
		Inlet	27 [1.063]	51 [2.008]	M10	7/16-14UNC-2B	27 [1.063]	55 [2.165]	M8
	090	Outlet	36 [1.417]	62 [2.441]	M10	1/2-13UNC-2B	36 [1.417]	55 [2.165]	M8
		Inlet	27 [1.063]	51 [2.008]	M10	7/16-14UNC-2B	27 [1.063]	55 [2.165]	M8

Unidirectional motor ports

Available ports for Group 3 unidirectional motors

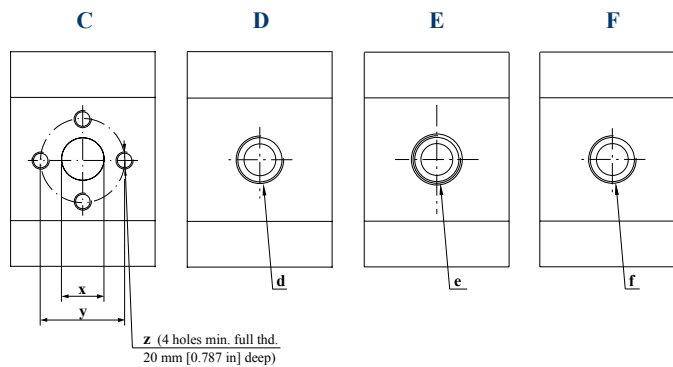

Group 3 Gear motors

Ports dimensions for unidirectional motors SNU3NN

Port type			C			D	E	F
Dimensions			x	y	z	d	e	f
Frame size	022	Outlet	20 [0.79]	40 [1.58]	M8	M26 x 1.5	¾ Gas (BSPP)	15/16-12UN-2B
		Inlet	20 [0.79]	40 [1.58]	M8	M26 x 1.5	¾ Gas (BSPP)	11/16-12UN-2B
	026	Outlet	20 [0.79]	40 [1.58]	M8	M26 x 1.5	¾ Gas (BSPP)	15/16-12UN-2B
		Inlet	20 [0.79]	40 [1.58]	M8	M26 x 1.5	¾ Gas (BSPP)	11/16-12UN-2B
	033	Outlet	27 [1.063]	51 [2.008]	M10	M33x2	1 Gas (BSPP)	15/8-12UN-2B
		Inlet	20 [0.79]	40 [1.58]	M8	M26 x 1.5	¾ Gas (BSPP)	15/16-12UN-2B
	038	Outlet	27 [1.063]	51 [2.008]	M10	M33x2	1 Gas (BSPP)	15/8-12UN-2B
		Inlet	20 [0.79]	40 [1.58]	M8	M26 x 1.5	¾ Gas (BSPP)	15/16-12UN-2B
	044	Outlet	27 [1.063]	51 [2.008]	M10	M33 x 2	1 Gas (BSPP)	15/8-12UN-2B
		Inlet	27 [1.063]	51 [2.008]	M10	M33 x 2	1 Gas (BSPP)	15/16-12UN-2B
	048	Outlet	27 [1.063]	51 [2.008]	M10	M33 x 2	1 Gas (BSPP)	15/8-12UN-2B
		Inlet	27 [1.063]	51 [2.008]	M10	M33 x 2	1 Gas (BSPP)	15/16-12UN-2B
	055	Outlet	27 [1.063]	51 [2.008]	M10	M33 x 2	1 Gas (BSPP)	17/8-12UN-2B
		Inlet	27 [1.063]	51 [2.008]	M10	M33 x 2	1 Gas (BSPP)	15/8-12UN-2B
	063	Outlet	36 [1.417]	62 [2.441]	M10	M42 x 2	1¼ Gas (BSPP)	17/8-12UN-2B
		Inlet	27 [1.063]	51 [2.008]	M10	M33 x 2	1 Gas (BSPP)	15/8-12UN-2B
	075	Outlet	36 [1.417]	62 [2.441]	M10	M42 x 2	1¼ Gas (BSPP)	17/8-12UN-2B
		Inlet	27 [1.063]	51 [2.008]	M10	M33 x 2	1 Gas (BSPP)	15/8-12UN-2B
	090	Outlet	36 [1.417]	62 [2.441]	M10	M42 x 2	1¼ Gas (BSPP)	17/8-12UN-2B
		Inlet	27 [1.063]	51 [2.008]	M10	M33 x 2	1 Gas (BSPP)	15/8-12UN-2B

Anti-cavitation check valve - SNM3GN

Danfoss offers an optional integral anti-cavitation check valve integrated in Group 3 motors bearing blocks. Available for all the displacements, the valve directs internally the flow from the motor outlet to the inlet, when the outlet pressure gets higher than the inlet one.

Valve schematic diagram

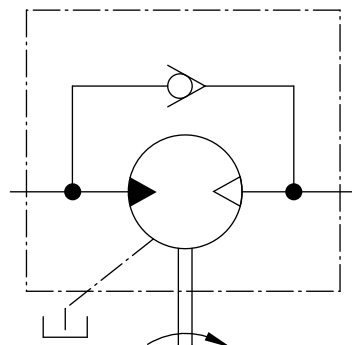

Group 3 Gear motors

Anticavitation check valve cross section

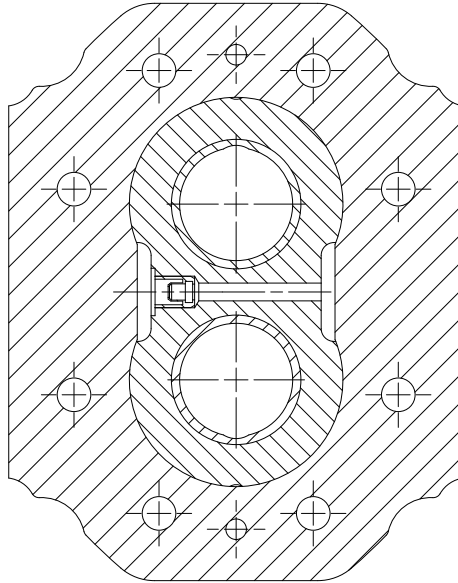

Dimensions

SNM3NN, SNU3NN – 01FA, 01DA and 01BA

Standard porting drawing for 01FA, 01DA and 01BA

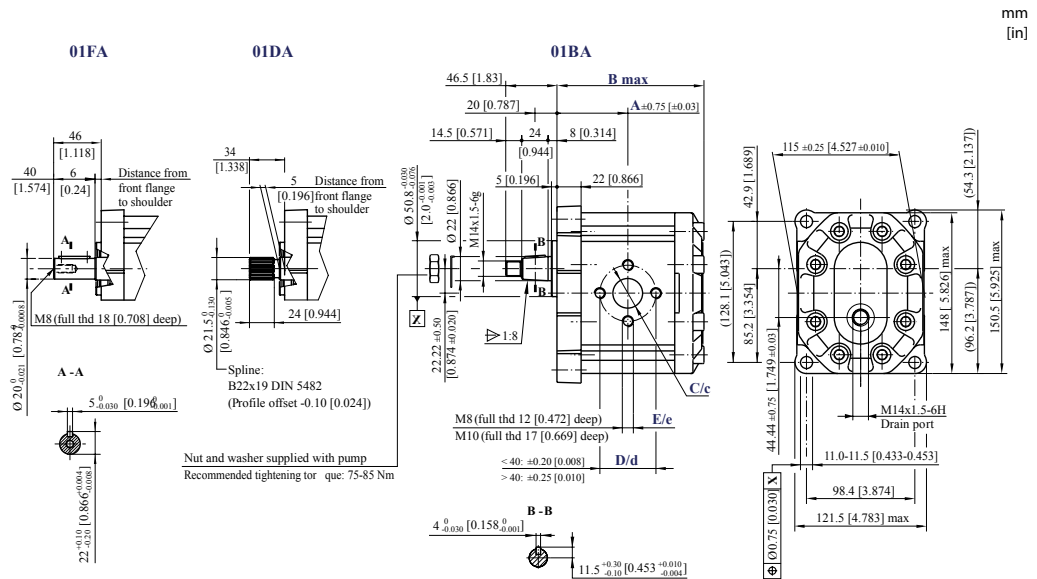

Bidirectional motors dimensions – 01FA, 01DA and 01BA

Frame size		022	026	033	038	044	048	055	063	075	090
Dimension	A	63.0 [2.480]	64.5 [2.539]	67.0 [2.637]	68.8 [2.708]	71.0 [2.795]	72.5 [2.854]	75.0 [2.952]	78.0 [3.070]	82.0 [3.228]	87.0 [3.425]
	B	132.5 [5.216]	135.5 [5.334]	140.5 [5.531]	144.0 [5.669]	148.5 [5.846]	151.5 [5.964]	156.5 [6.161]	162.5 [6.397]	170.5 [6.712]	180.5 [7.106]

Group 3 Gear motors

Bidirectional motors dimensions – 01FA, 01DA and 01BA (continued)

Frame size		022	026	033	038	044	048	055	063	075	090
Inlet/Outlet	C/c	20 [0.79]			27 [1.063]						
	D/d	40 [1.58]			51 [2.007]						
	E/e	M8			M10						

For unidirectional SKU1NN dimensions see [Ports dimensions](#) on page 74.

[For unidirectional motors no case drain hole into the rear cover.](#)

Model code examples and maximum shaft torque

Flange/drive gear	Model code example	Maximum shaft torque
01FA	SNM3NN/075BN01FAM1CACANNNN/NNNNN	210 N•m [1858 lb•in]
01DA	SNM3NN/026BN01DAM1C7C7NNNN/NNNNN	290 N•m [2566 lb•in]
01BA	SNM3NN/044BN01BAM1CACANNNN/NNNNN	350 N•m [3097 lb•in]

For further details on ordering, see [Model code](#) on page 63.

SNM3NN, SNU3NN – 02FA, 02DB and 02AA

Standard porting drawing for 02FA, 02DB and 02AA

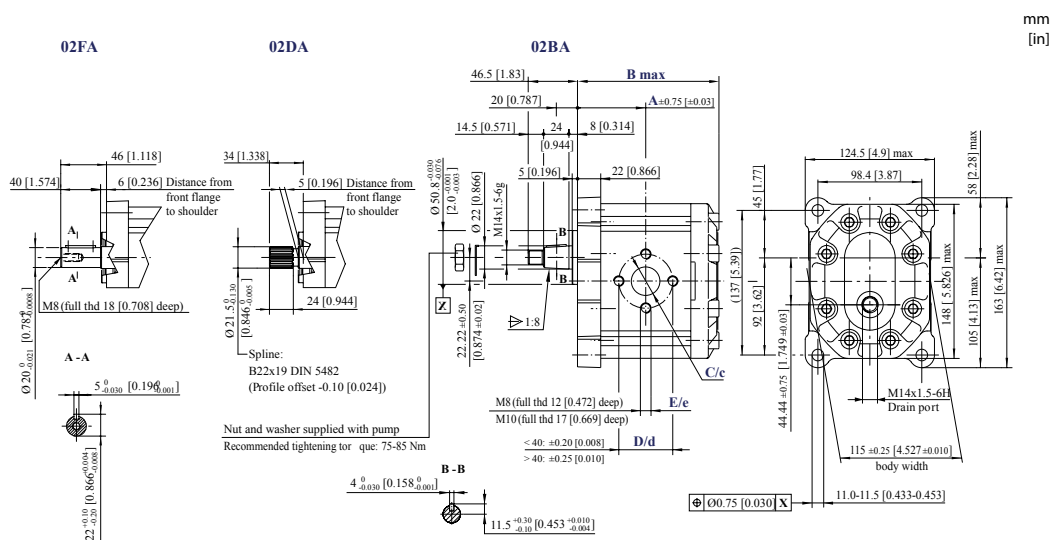

Bidirectional motors dimensions – 02FA, 02DA and 02BA

Frame size		022	026	033	038	044	048	055	063	075	090
Dimension	A	63.0 [2.480]	64.5 [2.539]	67.0 [2.637]	68.8 [2.708]	71.0 [2.795]	72.5 [2.854]	75.0 [2.952]	78.0 [3.070]	82.0 [3.228]	87.0 [3.425]
	B	132.5 [5.216]	135.5 [5.334]	140.5 [5.531]	144.0 [5.669]	148.5 [5.846]	151.5 [5.964]	156.5 [6.161]	162.5 [6.397]	170.5 [6.712]	180.5 [7.106]
Inlet/Outlet	C/c	20 [0.79]			27 [1.063]						
	D/d	40 [1.58]			51 [2.007]						
	E/e	M8			M10						

For unidirectional SNU3NN dimensions [Ports dimensions](#) on page 74.

[For unidirectional motors no case drain hole into the rear cover.](#)

Group 3 Gear motors

Model code examples and maximum shaft torque

Flange/drive gear	Model code example	Maximum shaft torque
03FB	SNM3NN/063BN03FBM1CACANNNN/NNNNN	300 N•m [2655 lb•in]
03BB	SNM3NN/090BN03BBM1CACANNNN/NNNNN	500 N•m [4425 lb•in]

For further details on ordering, see [Model code](#) on page 63.

SNM3NN, SNU3NN – 06AA

Standard porting drawing for 06AA

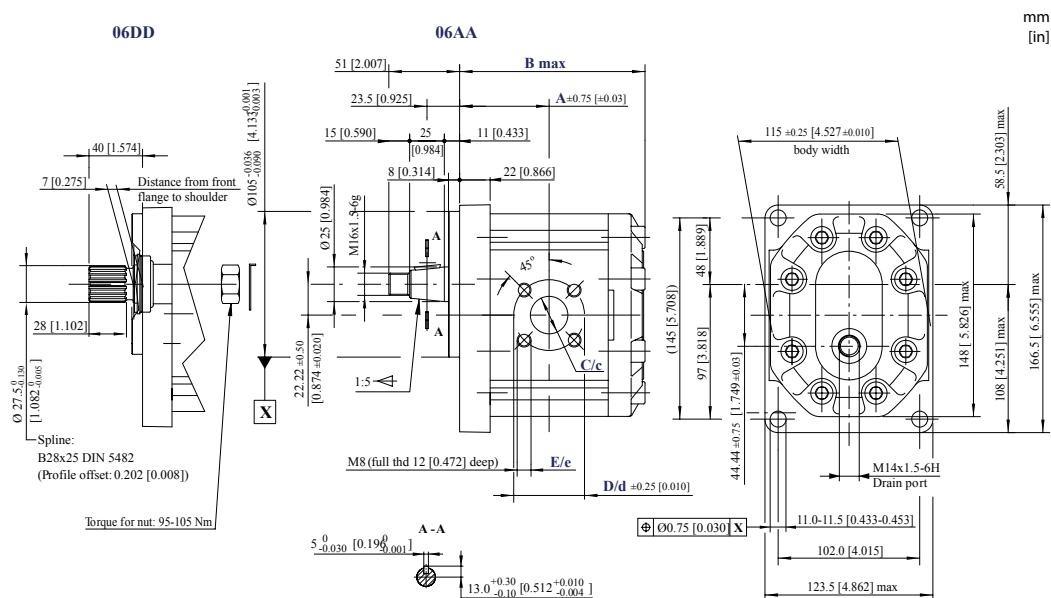

Bidirectional motors dimensions – 06DD AND 06AA

Frame size	022	026	033	038	044	048	055	063	075	090
A	63.0 [2.480]	64.5 [2.539]	67.0 [2.637]	68.8 [2.708]	71.0 [2.795]	72.5 [2.854]	75.0 [2.952]	78.0 [3.070]	82.0 [3.228]	87.0 [3.425]
B	132.5 [5.216]	135.5 [5.334]	140.5 [5.531]	144.0 [5.669]	148.5 [5.846]	151.5 [5.964]	156.5 [6.161]	162.5 [6.397]	170.5 [6.712]	180.5 [7.106]
C/c	20 [0.79]	27 [1.063]								
D/d	40 [1.58]	51 [2.007]								
E/e	M8	M10								

For unidirectional SNU3NN dimensions, see [Ports dimensions](#) on page 74.

[For unidirectional motors no case drain hole into the rear cover.](#)

Model code examples and maximum shaft torque

Flange/drive gear	Model code example	Maximum shaft torque
06DD	SNM3NN/044BN06DDM1BBBNNNNN/NNNNN	300 N•m [2655 lb•in]
06AA	SNM3NN/022BN06AAM1BABANNNN/NNNNN	450 N•m [3982 lb•in]

For further details on ordering, see [Model code](#) on page 63.

Group 3 Gear motors

SNM3NN, SNU3NN – 07BC, 07SA and 07GA

Standard porting drawing for 07BC, 07SA and 07GA

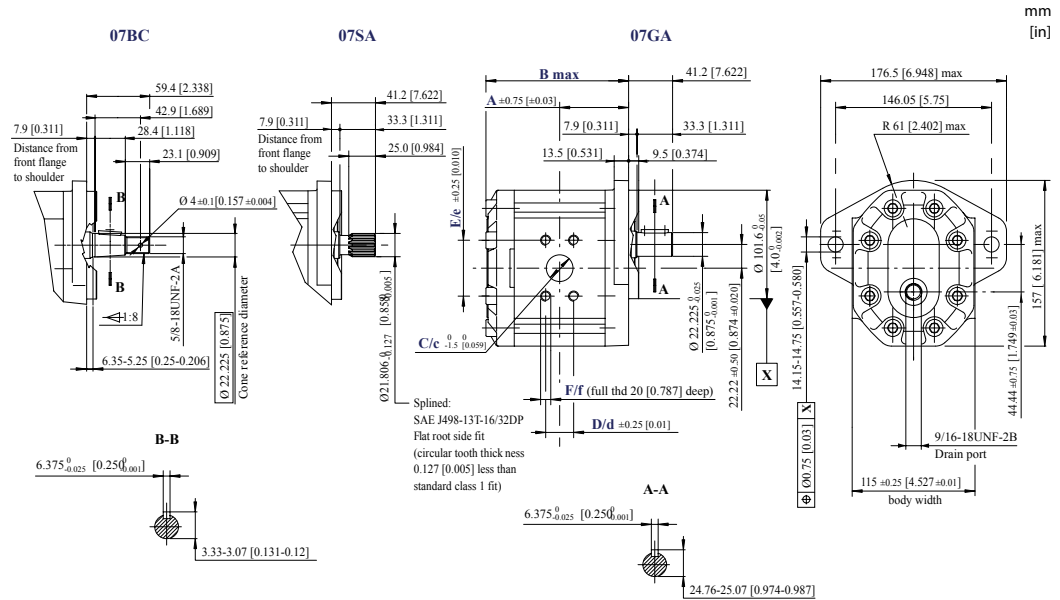

Bidirectional motors dimensions – 07BC, 07SA and 07GA

Frame size		022	026	033	038	044	048	055	063	075	090
Dimension	A	63.0 [2.480]	64.5 [2.539]	67.0 [2.637]	68.8 [2.708]	71.0 [2.795]	72.5 [2.854]	75.0 [2.952]	78.0 [3.070]	82.0 [3.228]	87.0 [3.425]
	B	132.5 [5.216]	135.5 [5.334]	140.5 [5.531]	144.0 [5.669]	148.5 [5.846]	151.5 [5.964]	156.5 [6.161]	162.5 [6.397]	170.5 [6.712]	180.5 [7.106]
Inlet/Outlet	C/c	25.4 [1]		31.8 [1.251]							
	D/d	26.19 [1.031]		30.18 [1.188]							
	E/e	52.37 [2.061]		58.72 [2.311]							
	F/f	3/8–16UNC–2B		7/16–14UNC–2B							

For unidirectional SNU3NN dimensions, see [Ports dimensions](#) on page 74.

For unidirectional motors no case drain hole into the rear cover.

Model code examples and maximum shaft torque

Flange/drive gear	Model code example	Maximum shaft torque
07BC	SNM3NN/026BN07BCM6A3A3NNNN/NNNNN	300 N·m [2655 lb·in]
07SA	SNM3NN/063BN07SAM6A4A4NNNN/NNNNN	270 N·m [2389 lb·in]
07GA	SNM3NN/090BN07GAM6A4A4NNNN/NNNNN	230 N·m [2035 lb·in]

For further details on ordering, see [Model code](#) on page 63.

Products we offer:

- DCV directional control valves
- Electric converters
- Electric machines
- Electric motors
- Gear motors
- Gear pumps
- Hydrostatic motors
- Hydrostatic pumps
- Orbital motors
- PLUS+1® controllers
- PLUS+1® displays
- PLUS+1® joysticks and pedals
- PLUS+1® operator interfaces
- PLUS+1® sensors
- PLUS+1® software
- PLUS+1® software services, support and training
- Position controls and sensors
- PVG proportional valves
- Steering components and systems
- Telematics

Danfoss Power Solutions is a global manufacturer and supplier of high-quality hydraulic and electric components. We specialize in providing state-of-the-art technology and solutions that excel in the harsh operating conditions of the mobile off-highway market as well as the marine sector. Building on our extensive applications expertise, we work closely with you to ensure exceptional performance for a broad range of applications. We help you and other customers around the world speed up system development, reduce costs and bring vehicles and vessels to market faster.

Danfoss Power Solutions – your strongest partner in mobile hydraulics and mobile electrification.

Go to www.danfoss.com for further product information.

We offer you expert worldwide support for ensuring the best possible solutions for outstanding performance. And with an extensive network of Global Service Partners, we also provide you with comprehensive global service for all of our components.

Hydro-Gear

www.hydro-gear.com

Daikin-Sauer-Danfoss

www.daikin-sauer-danfoss.com

Local address:

**Danfoss
Power Solutions (US) Company**
2800 East 13th Street
Ames, IA 50010, USA
Phone: +1 515 239 6000

**Danfoss
Power Solutions GmbH & Co. OHG**
Krokamp 35
D-24539 Neumünster, Germany
Phone: +49 4321 871 0

**Danfoss
Power Solutions ApS**
Nordborgvej 81
DK-6430 Nordborg, Denmark
Phone: +45 7488 2222

**Danfoss
Power Solutions Trading
(Shanghai) Co., Ltd.**
Building #22, No. 1000 Jin Hai Rd
Jin Qiao, Pudong New District
Shanghai, China 201206
Phone: +86 21 2080 6201

Danfoss can accept no responsibility for possible errors in catalogues, brochures and other printed material. Danfoss reserves the right to alter its products without notice. This also applies to products already on order provided that such alterations can be made without subsequent changes being necessary in specifications already agreed. All trademarks in this material are property of the respective companies. Danfoss and the Danfoss logotype are trademarks of Danfoss A/S. All rights reserved.