

Gripper

AF316-16,20,25

Character

- Cross roller guide type
- High repeatability & long life by jaw united cross roller
- Magnetic sensor is available for open-close sensing
- Suitable to grip a small and light workpiece
- Twisted it is strong hardness plunger
- For precise positioning of individual gripping jaw



Cross roller guide type

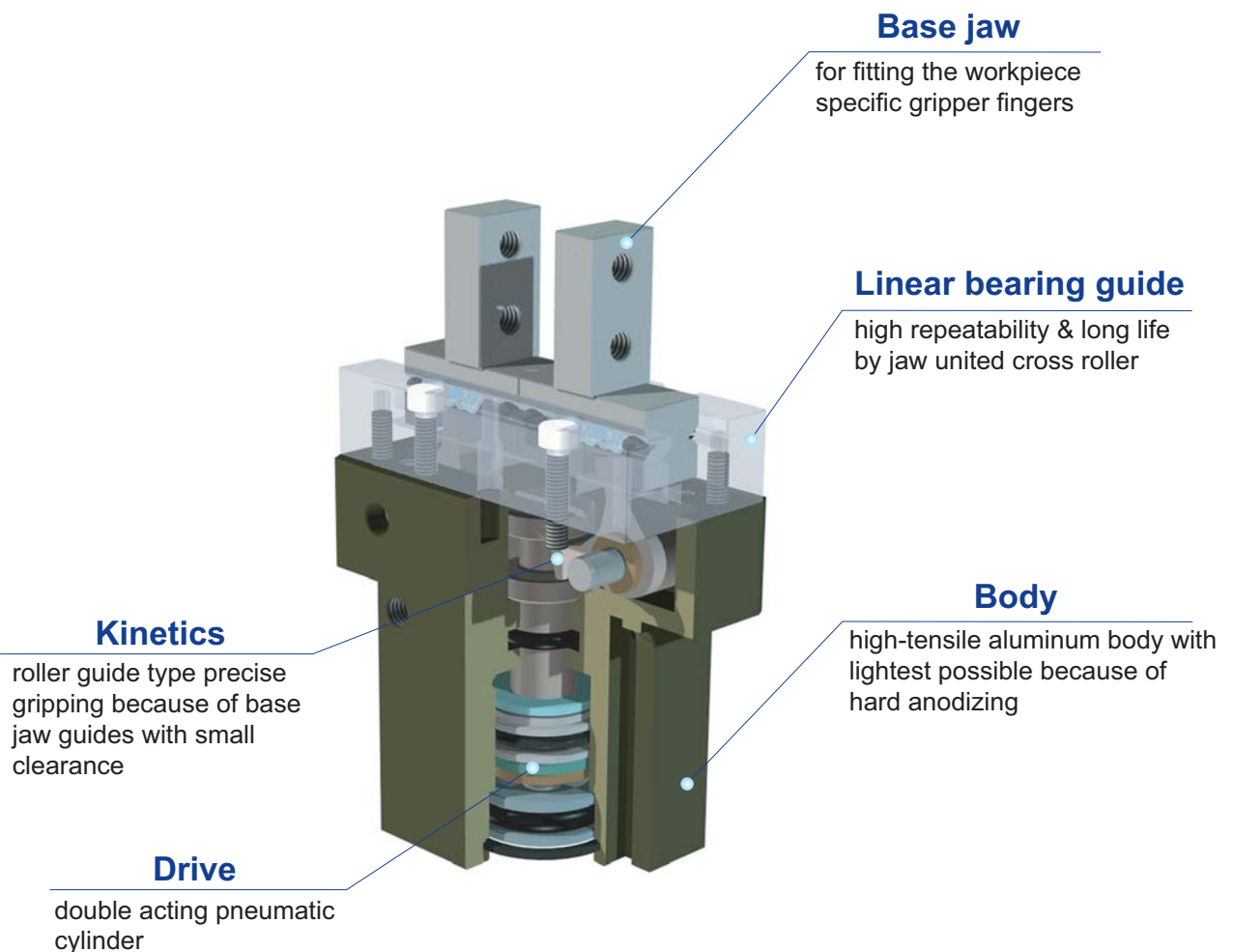

AF316

Exploded view

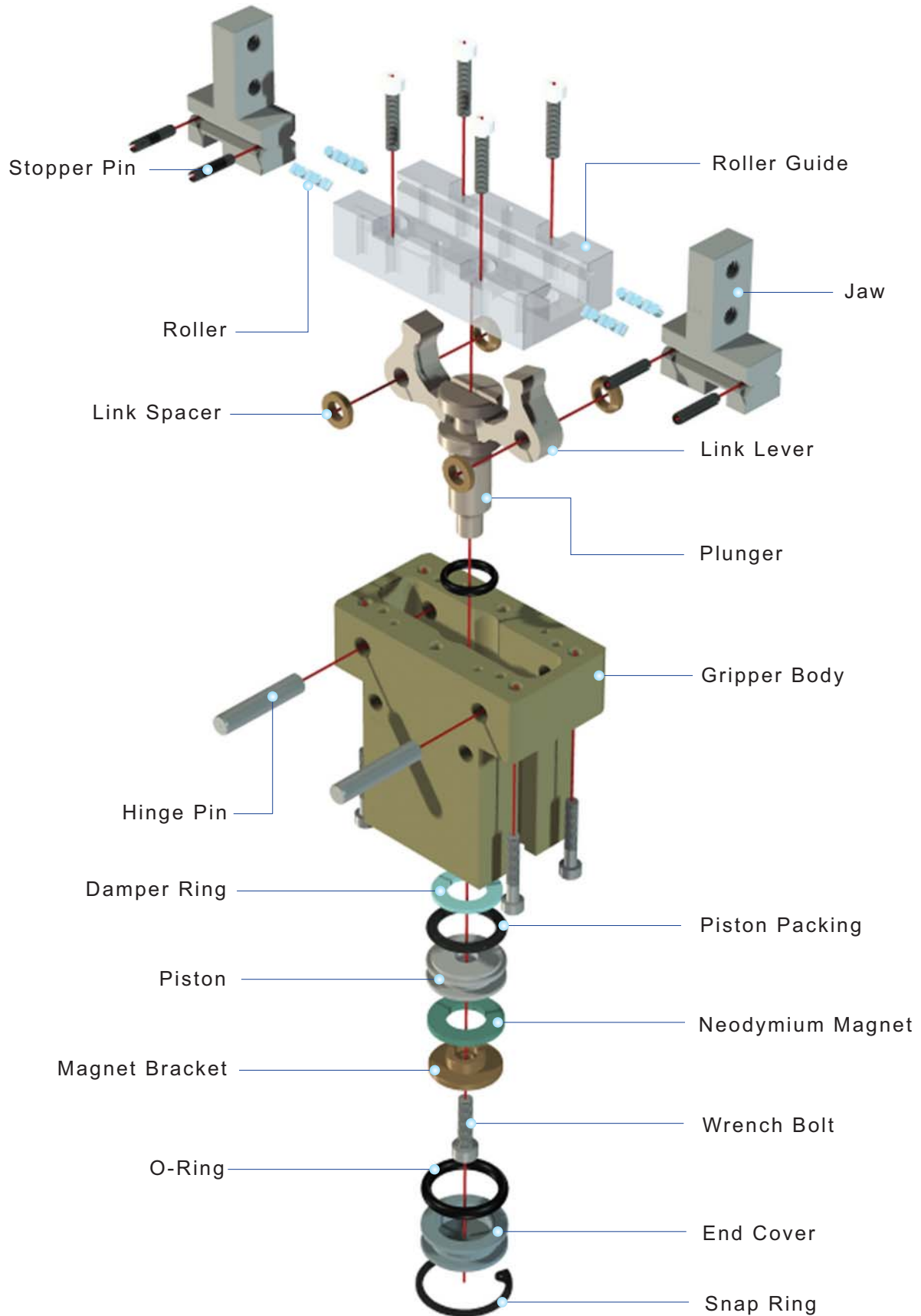

AF316

Ordering Code

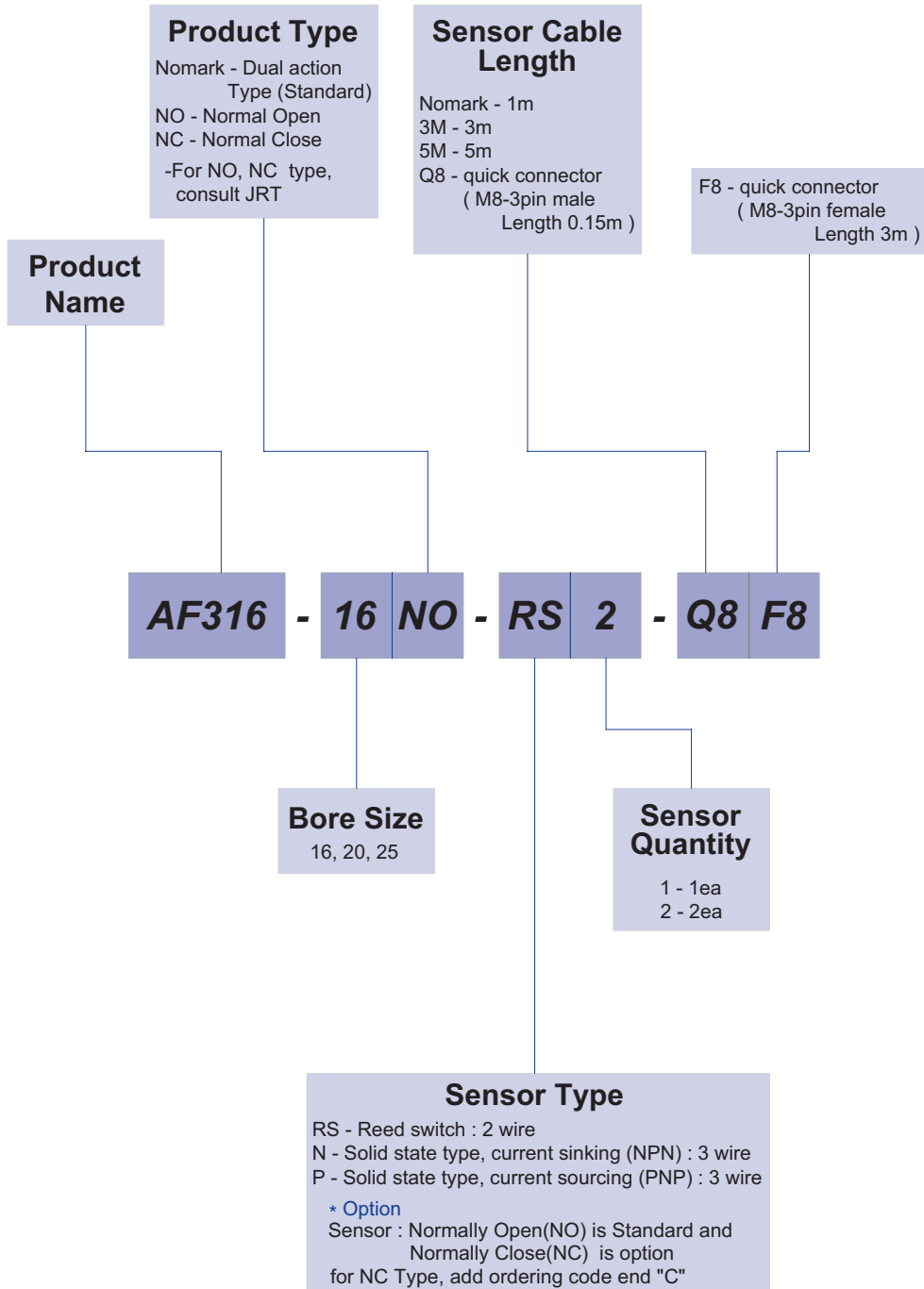

The delivery of * mark option is longer than a standard, So inquire of JRT

AF316

Specification

P=Air Pressure[bar] , L=Exertion length[mm]

Products Name	AF316-16	AF316-20	AF316-25	Unit
Stroke	8	10	14	mm
Weight	0.21	0.31	0.55	kg
Max. length of attach	50	65	80	mm
Fitting size	M5	M5	M5	
Gripping force:Open	15.3P/(1+0.0075L)	28.35P/(1+0.005L)	42.28P/(1+0.003L)	N
Gripping force:Close	9.52P/(1+0.0075L)	27.96P/(1+0.005L)	39.83P/(1+0.003L)	N
Air consumption per cycle	1.4	2.7	6.1	cm ³
Closing / Opening time	0.01 / 0.01	0.01 / 0.01	0.01 / 0.01	sec
* Repeat accuracy	0.01	0.01	0.01	mm
Max.cycle per minute	60	60	40	
Operating pressure	3~7			bar
Ambient temperature	-5 to 60			°C
Lubrication	Needless			

* After 100 consecutive strokes to end positions

Gripping Force per exertion length

Legend : ■ 7[bar] ■ 5[bar] ■ 3[bar]

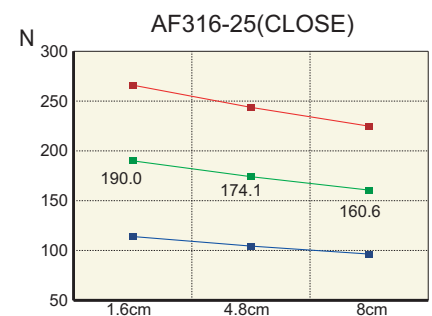
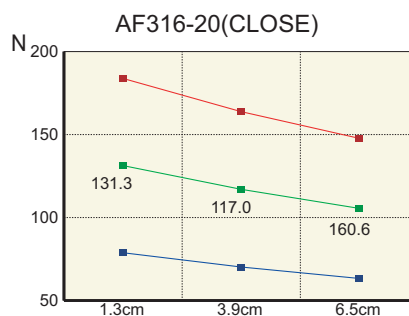
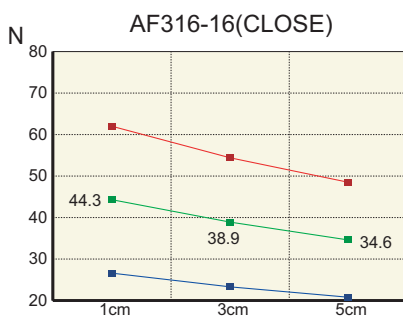
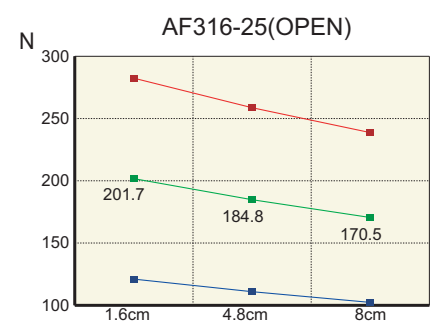
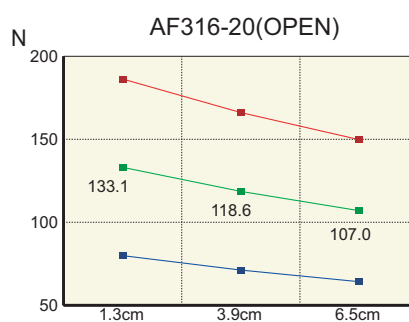
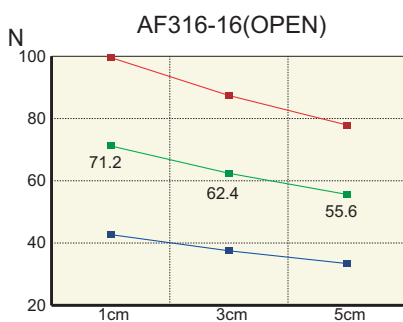

AF316

AF316-25

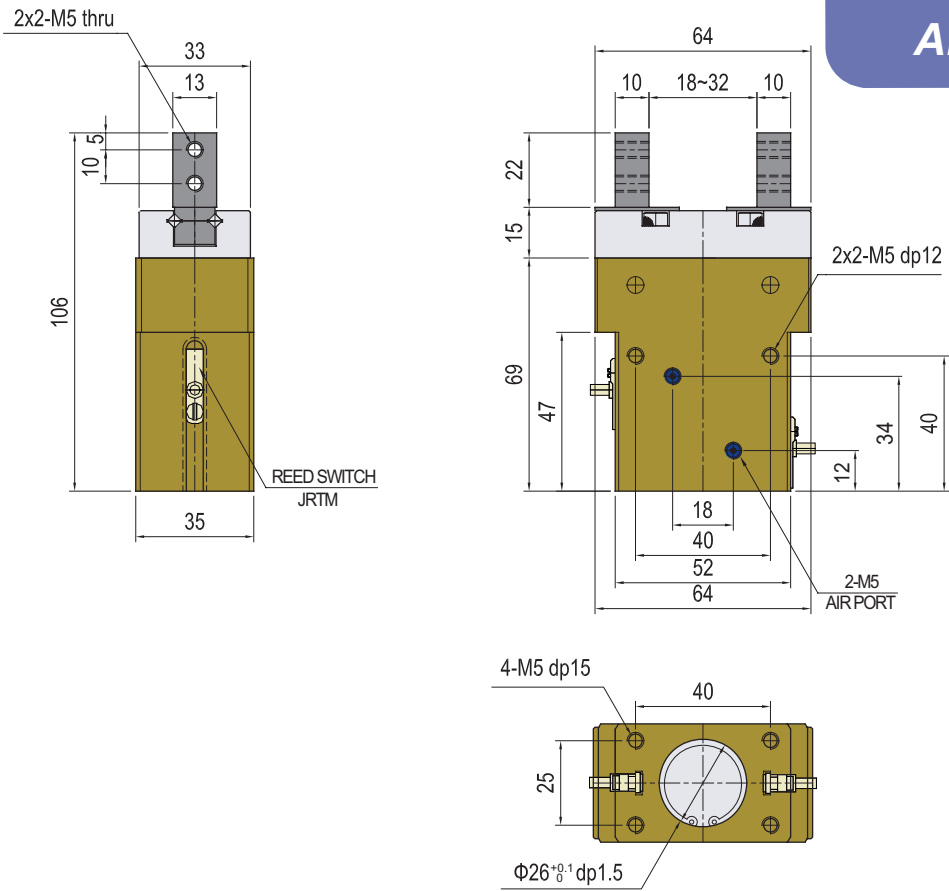

Note